Some global causal properties of certain classes of spacetimes

Ph. D. Dissertation

Luis Alberto Aké Hau



Directed by:
Dr. José Luis Flores Dorado and Dr. Miguel Sánchez Caja

Tesis Doctoral
Departamento de Álgebra, Geometría y Topología
Programa de Doctorado en Matemáticas
Facultad de Ciencias
Universidad de Málaga
2018



José Luis Flores Dorado
Dpto. Álgebra, Geometría y Topología
Facultad de ciencias, Universidad de Málaga
29080-Málaga, Spain

Miguel Sánchez Caja
Departamento de Geometría y Topología
Facultad de ciencias, Universidad de Granada
18071-Granada, Spain

Por medio de la presente, José Luis Flores Dorado y Miguel Sánchez Caja, como directores de la tesis doctoral, y tutor en el primer caso, de D. Luis Alberto Aké Hau,

Autorizamos la presentación de la misma para que pueda ser defendida como Tesis Doctoral según la legislación vigente.

Además,

Informamos que el trabajo mencionado es totalmente original y que ha dado lugar las siguientes publicaciones que lo avalan:

1. L. Aké, M. Sánchez: "Compact affine manifolds with precompact holonomy are geodesically complete", *J. Math. Anal. Appl.* **436** (2016), 1369-1371.
2. L. Aké, J. Herrera: "Spacetime coverings and the Causal Boundary". *J. High Energy Physics* **04** (2017) 051.
3. L. Aké, J.L. Flores, J. Herrera: "Causality and C-completion of Multiwarped Spacetimes", *Class. Quant. Grav.* **35** (3), 035014, 2018.

Hacemos constar que ningún contenido ni resultado de las anteriores publicaciones ha sido utilizado en ninguna otra tesis ni trabajo de investigación. Para que así conste y surta los efectos oportunos, firmamos el presente escrito en Málaga a 9 abril de 2018.

José Luis Flores Dorado

Miguel Sánchez Caja

Esta tesis ha sido financiada por el Consejo Nacional de Ciencia y Tecnología (CONACyT, México) y por los Proyectos de Investigación MTM2013-47828-C2-2-P y MTM2016-78807-C2-2-P del Ministerio de Economía y Competitividad.

Introduction	7
1 Spacetime coverings and the c-boundary	25
1.1 Sequential topologies and limit operators	25
1.1.1 Spacetime covering projections: The causal ladder and main properties	28
1.2 Partial boundaries under the action of the group	29
1.3 The c-completion under the action of the group	34
1.3.1 Point set level	35
1.3.2 At the chronological level	38
1.3.3 At the topological level	39
1.3.4 Group actions with the finite chronology property	40
1.4 On the optimality of the results: some examples	46
1.5 A physical application: Quotients on Robertson-Walker Spacetimes	57
2 Causality and c-completion of multiwarped spacetimes	61
2.1 The causal structure of doubly warped spacetimes	61
2.1.1 Position into the causal ladder	65
2.2 Case of interest: Generalized Robertson-Walker model	68
2.3 The future c-completion of doubly warped spacetimes	71
2.3.1 Finite warping integrals	76
2.3.2 One infinite warping integral	77
2.4 The past c-completion of doubly warped spacetimes	82
2.5 The total c-completion of doubly warped spacetimes	83
2.6 The general multiwarped case	86
2.7 Some examples of interest	88
3 Splitting of globally hyperbolic spacetimes with timelike boundary	93
3.1 Preliminaries on spacetimes with timelike boundary	93
3.1.1 Generalities: boundaries, time-orientation and coordinates	93
3.1.2 Conditions on causality	95
3.1.3 Continuous vs H^1 -causal curves	98
3.2 The topological splitting	100
3.2.1 Higher steps of the causal ladder.	100
3.2.2 Extended Geroch's proof.	103

3.2.3	Hypersurfaces with boundary, achronal sets and edges	104
3.3	Smooth and H^1 causal futures and pasts	107
	Compact affine manifolds with precompact holonomy are complete	111
	Bibliography	113

Causality is a specific tool of Lorentzian Geometry, with a clear physical motivation, which has played a central role in proving important theorems about the global structure of spacetimes. Causality conditions are classified in terms of the so called *causal ladder*, whose steps determine how these conditions are logically related. Each of these levels presents some specific properties, standing out at the top one, which is occupied by the condition of *global hyperbolicity*. In fact, it is believed that any physical spacetime must be globally hyperbolic (roughly, this is the content of the *strong cosmic censorship hypothesis*), and then, will admit a global splitting in terms of a *Cauchy surface*, on which the Einstein equations can be posed as an initial value problem.

Causality theory also provides a boundary construction for the very general class of strongly causal spacetimes, namely, the so-called *causal boundary* or just *c-boundary*. This boundary is less commonly used in General Relativity than the *conformal* one, because some classical spacetimes present a simple conformal boundary with quite a few of interesting properties. However, beyond such examples, there is no a general way to ensure that the conformal boundary exists. In contraposition, the c-boundary is not only conformally invariant but also intrinsic and it can be computed systematically; such properties make it more suitable in general situations. This includes the holographic principle, which original started at a restricted situation concerning the conformal boundary of Anti-de Sitter spacetime for the AdS/CFT correspondence.

The main purpose of this memory is to improve our knowledge about the c-boundary and the causal ladder of some important classes of spacetimes. Concretely, we have studied systematically the c-boundary in quotients of spacetimes under the action of groups of isometries (Chapter 1) and in the class of multiwarped spacetimes (Chapter 2); then, we have focused on spacetimes with a timelike boundary, including its causal ladder and the globally hyperbolic ones (Chapter 3).

Next, we will provide a brief account of these results. We will use the general language and concepts of Differential Geometry, plus some more specific notions in Lorentzian Geometry. For the convenience of the reader, the present chapter also includes a section with the general background for Lorentzian Geometry (including the causal ladder and c-boundary) to be used.

Presentation of results.

The holographic principle [100, 97] states that the information of a particular space can be thought as encoded on a lower-dimensional boundary of the space, thus considering the origi-

nal space as an hologram of the latter. One of the best understood examples of such a principle is the AdS/CFT correspondence, or Maldacena duality [69], where a dual description between the string theory on the bulk space (typically, the product of anti-de Sitter AdS_n by a round sphere \mathbb{S}^m , or by another compact manifold) and a Conformal Field Theory without gravity on the boundary of the initial space, is achieved. Currently, there is a growing interest in the study of the realization of such a holographic principle with other bulk spaces [52, 49, 60], particularly de Sitter spacetime dS_n [105, 96, 29, 50].

As it is apparent, the conjecture relies strongly on the notion of boundary for Lorentz manifolds. However, the problem to attach a natural boundary to any Lorentz manifold which encodes relevant information about its conformal structure and related elements (event horizons, singularities, etc.) has been a long standing issue along the last four decades. Among the several constructions proposed (see [46, 57, 92] for nice reviews on the classical elements and [35, 38] for updated progress), two approaches have had a specially important role in general relativity: the conformal and the causal boundaries.

The conformal boundary is the most applied one in mathematical relativity; indeed, several notions such as asymptotic flatness or tools such as Penrose–Carter diagrams rely on it. In the original approach of the AdS/CFT correspondence, the conformal boundary was chosen as the holographic one. In fact, anti-de Sitter spacetime can be conformally embedded in the Lorentz–Minkowski model, obtaining a simple (and non-compact) conformal boundary. However, such a boundary has important limitations as it is an *ad hoc* construction: no general formalism determines when the conformal boundary of a reasonably general spacetime is definable, intrinsic, unique and containing useful information of the spacetime (however, the progress in the issues of uniqueness is bigger, see [27] and [35, Section 4]). In fact, as suggested in Bernstein, Maldacena and Nastase work [12]), there are problems to use the conformal boundary for holography on plane waves.

Indeed, Marolf and Ross [71] realized that the conformal boundary is not available for non-conformally flat plane waves. So, they proposed a redefinition of the c-boundary applicable to such waves [72]. Such a redefinition was refined further and systematically studied by Flores [34]. From a broader viewpoint in Lorentzian Geometry, the intrinsic nature of the c-boundary and the possibility to compute it systematically motivated its systematic study, which was carried out in [35].

Moreover, it is also proved in the latter reference that, when the conformal boundary exists, then it agrees with the c-boundary under quite general assumptions. In this framework, it is natural to study *globally hyperbolic spacetimes with timelike boundary*. These are manifolds with boundary such that its open interior is not intrinsically globally hyperbolic (they contain *(conformal) naked singularities*, all of them contained precisely in the boundary); however, the existence of the boundary allows to obtain compactness properties analog to those of the globally hyperbolic ones. A first study of these properties was carried out in Solís' thesis [95]. In spite of its importance, the variety and depth of problems appearing in these spacetimes is huge, and they are far from being systematically studied.

Such a general background has been the framework and motivation for our results, carried out in the three chapters plus the appendix of this memory, as explained next.

CHAPTER 1. Linked to the problem of AdS/CFT correspondence, our aim is to present the c-boundary of different classes of quotient Lorentz manifolds, allowing the study of such a correspondence with different bulk spaces.

Let us consider first the case when M is a Lorentz manifold with constant negative curvature, and so, a spacetime that can be locally modelled by the Anti-de Sitter spacetime. Recalling that the universal covering $\tilde{\text{AdS}}$ is maximal, simply-connected and with constant negative curvature, it is expected that M can be described as a quotient space of $\tilde{\text{AdS}}$ by an appropriate

group of isometries (in fact, the existence of such an appropriate group was proved by Mess [75] for certain spacetime topologies). This is the particular case of the BTZ blackholes, the $(2 + 1)$ -model of spacetime first introduced by Bañados, Teitelboim and Zanelli [8]; and the Hawking-Page reference space [62], whose representations as a quotient of the Anti-de Sitter model are well known [7, 103, 104].

Due to the fact that the c-boundary is well known for $\tilde{\text{AdS}}$ (see [5, Section 4.1]), the following question, particularly natural from the mathematical viewpoint, arises: given two (general) Lorentz manifolds M and V where M is constructed as the quotient of V by some group of isometries, what is the relation between the causal boundaries and completions of M and V ? An adequate answer for this question will give us tools to easily compute the causal completion of M once we know the corresponding completion on V . For instance, such a result will be applicable to models like the BTZ blackholes or the Hawking-Page reference model, besides other models constructed in a similar way (as the case of Cosmic Strings, see [51]). It will also give us relevant information of the c-completion on V whenever the c-completion in M is known.

The first studies in this direction are due to Harris [56]. Indeed, he studied how isometrical actions affect the causal structures of the spacetimes, paying special attention to the future c-boundary and related concepts (such as strong causality). Concretely, he considers a projection $\pi : V \rightarrow M$ given by a discrete subgroup G of isometries acting freely and properly discontinuously in V , i.e., where $M = V/G$ and the elements on M represents G -orbits in V . In this settings, Harris characterizes the strong causality and global hyperbolicity of M in terms of the global causal structure of V . Moreover, under the assumption that M is distinguishing (which implies, in particular, that so is V), necessary conditions are introduced in order to ensure that the future causal completion of M is homeomorphic to an appropriate quotient of the future causal completion of V .

In Chapter 1, our aim is to extend the results obtained by Harris for the future causal completion to the full c-completion. However, several problems have to be addressed first. On the one hand, the main result in [56] imposes that both, the future c-boundary of M and V have only spacelike future boundaries. Even though this condition is reasonable (recall, for instance, the final example of his paper), it seems too strong in the c-completion setting, where the study of timelike boundary points becomes specially relevant. Moreover, in contrast to the partial boundary case, the c-completion requires the study of both the so-called S-relation between future and past sets, and some ‘‘compatibility’’ between the topology of the future and past completions.

The first main result in Chapter 1 is Thm. 1.17, where a full description of the relation between the future c-boundaries of a spacetime and those of its quotient is developed. The second main result in Chapter 1, establishes the relation between the total c-completion of a spacetime and its quotient, namely:

Theorem. (Thm. 1.44) *Let $\pi : V \rightarrow M$ be a spacetime covering projection and consider $\bar{\pi} : \bar{V} \rightarrow \hat{M}_\phi \times \check{M}_\phi$ one extension map, where \bar{V} and \bar{M} denotes the c-completion of V and M respectively.*

Assume that the image of the map $\bar{\pi}$ lies on $\bar{M} \subset \hat{M}_\phi \times \check{M}_\phi$ and, then, consider \bar{M} as its codomain. If $\bar{\pi}$ is surjective, then it defines the following relation of equivalence between points in \bar{V} : two points are \sim_G -related if they project onto the same point in \bar{M} . Therefore, if we denote the quotient space by \bar{V}/G the quotient space, we obtain the following commutative diagram:

$$\begin{array}{ccc} \bar{V} & & \\ \bar{i} \downarrow & \searrow \bar{\pi} & \\ \bar{V}/G & \xrightarrow{\bar{j}} & \bar{M} \end{array}$$

where $\bar{\pi}$ is the natural projection to the quotient and \bar{j} is the induced bijection.

At the chronological level, and once an appropriate chronological relation is defined on \bar{V}/G , it follows that

(CH) the map \bar{j} is a chronological isomorphism.

Finally, at the topological level, \bar{j} satisfies the following properties:

(TP1) The map \bar{j} is continuous if one of the following hypotheses hold:

- (i) $\bar{\pi}$ satisfies that $\bar{\pi}(\bar{P}, \phi) = (P, \phi)$ and $\bar{\pi}(\phi, \bar{F}) = (\phi, F)$ (this follows if, for instance, π is tame or (V, G) is finitely chronological); and M has no sequence with (future or past) divergent lifts.
- (ii) $\bar{\pi}(\bar{P}, \phi) = (P, \phi)$, $\bar{\pi}(\phi, \bar{F}) = (\phi, F)$ and \bar{M} has no lightlike boundary points.

(TP2) If (V, G) is finitely chronological, the map \bar{j} is open.

In particular, $\bar{\pi}$ is well defined as a map to \bar{M} , it is surjective, univocally determined and induces a homeomorphism and chronological isomorphism between \bar{V}/G and \bar{M} if one of the following assertions is satisfied:

- (a) (V, G) is finitely chronological and M admits no sequence with (future or past) divergent lifts.
- (b) (V, G) is finitely chronological, both \hat{V}, \check{V} are Hausdorff and \bar{M} has no lightlike boundary points.
- (c) (V, G) is finitely chronological, \bar{V} has no lightlike boundary points, and both \hat{V}, \check{V} are Hausdorff and have closed G -orbits. In particular, if π is (future and past) tame and there are no constant sequences with divergent lifts in M , then the G -orbits in \hat{V} and \check{V} will be closed.

What is more, the sharpness of the results is pointed out in section 1.4. Here, a big number of examples that do not satisfy the technical conditions in Thm. 1.17 and Thm. 1.44 are exhibited, proving that these conditions are optimal. Finally, a physical application of our results to Generalized Robertson Walker spacetimes is provided at the end of the chapter.

CHAPTER 2. In order to construct a background space in string theory where anti-de Sitter space is embedded, one can use a warping product with a compact manifold. Due to the compactness of the latter, it is not difficult to obtain the c-boundary of the product from the c-boundary of AdS_n (see for instance [5]). However, if de Sitter spacetime is considered, the no-go theorems (first due to Gibbons [50] and Maldacena and Núñez [70]) ensure that there is no way to "embed it in a string theory" by a product with a compact manifold. There exist several ways to circumvent these no-go theorems, for instance, by considering warped product with non-compact Riemannian manifolds, but this complicates significantly the computation of the boundary.

These problems motivate the systematic study of the c-boundary for the so-called *multi-warped spacetimes*, a class of spacetimes wide enough to cover the situations described above. A *multiwarped spacetime* (V, \mathfrak{g}) can be written as $V = (a, b) \times M_1 \times \cdots \times M_n$, $-\infty \leq a < b \leq \infty$, and

$$\mathfrak{g} = -dt^2 + \alpha_1 h_1 + \cdots + \alpha_n h_n, \quad (1)$$

where $\alpha_i : (a, b) \rightarrow \mathbb{R}$ are positive smooth functions and (M_i, h_i) are Riemannian manifolds, for all $i = 1, \dots, n$. As far as we know, the unique result in the literature about the c-boundary of these spacetimes is due to Harris [56]. This result covers the case of warped products of anti-de Sitter with compact manifolds. However, it does not provide a complete description of the boundary when the product of de Sitter with non-compact manifolds is considered.

The aim of Chapter 2 is twofold. First, we develop a systematic study of the causal structure and global causality properties of multiwarped spacetimes. Then, we use this approach to describe in full detail the c-boundary of these spacetimes by considering some mild hypotheses on the integrals of the warping functions.

Our main results for the partial future c-boundary are Thms. 2.18 and 2.25 in the doubly warped case, and Thm. 2.33 in the general multiwarped case. They include the cases covered by Harris (Prop. 2.11) as well as some extensions. Concretely, we are able to remove the completeness hypothesis on the Riemannian factors, and we also include the case when just one warping integral is infinite ($k+1 = n$).

Moreover, the total c-boundary is considered in Section 2.5. Recall that, now, the future and past causal boundaries must be suitably merged. A careful description is carried out in Thm. 2.30 for the doubly warped case, and in Thm. 2.35 for the general multiwarped case. We will state in here previous theorem in order to give a glimpse of the structure for the c-completion of these kind of spacetimes.

Theorem. (Thm. 2.35)¹ *Let (V, g) be a multiwarped spacetime, and take any $\mathfrak{d} \in (a, b)$. Then, we have the following possibilities for the total c-completion of V :*

- (i) *If the integrals of the warping functions along both, $[\mathfrak{d}, b)$ and $(a, \mathfrak{d}]$, are all finite, then*

$$\overline{V} \leftrightarrow [a, b] \times M_1^C \times \dots \times M_n^C. \quad (2)$$

- (ii) *If the integrals of the warping functions along $(a, \mathfrak{d}]$ are all finite, and along $[\mathfrak{d}, b)$ are finite except the i -th one, then*

$$\overline{V} \equiv \begin{cases} \check{V} \cup \hat{\partial}^b V \leftrightarrow ([a, b] \times \prod_{k=1}^n M_k^C) \cup (\prod_{k \neq i} M_k^C \times (\mathcal{B}(M_i) \cup \{\infty\})) \\ \check{\partial}^a V \cup \hat{V} \leftrightarrow (\{a\} \times \prod_{k=1}^n M_k^C) \cup (\prod_{k \neq i} M_k^C \times (B(M_i) \cup \{\infty\})). \end{cases}$$

- (iii) *If the integrals of the warping functions along $[\mathfrak{d}, b)$ are all finite, and along $(a, \mathfrak{d}]$ are finite except the j -th one, then*

$$\overline{V} \equiv \begin{cases} \hat{\partial}^b V \cup \check{V} \leftrightarrow (\{b\} \times \prod_{k=1}^n M_k^C) \cup (\prod_{k \neq j} M_k^C \times (B(M_j) \cup \{-\infty\})). \\ \hat{V} \cup \check{\partial}^a V \leftrightarrow ((a, b] \times \prod_{k=1}^n M_k^C) \cup (\prod_{k \neq j} M_k^C \times (\mathcal{B}(M_j) \cup \{-\infty\})). \end{cases}$$

- (iv) *If the integrals of the warping functions along $[\mathfrak{d}, b)$ are finite except the i -th one, and along $(a, \mathfrak{d}]$ are also finite except the j -th one, then*

$$\overline{V} \equiv \begin{cases} \hat{\partial}^b V \cup \check{V} \leftrightarrow (\prod_{k \neq i} M_k^C \times (\mathcal{B}(M_i) \cup \{\infty\})) \cup (\prod_{k \neq j} M_k^C \times (B(M_j) \cup \{-\infty\})) \\ \hat{V} \cup \check{\partial}^a V \leftrightarrow (\prod_{k \neq i} M_k^C \times (B(M_i) \cup \{\infty\})) \cup (\prod_{k \neq j} M_k^C \times (\mathcal{B}(M_j) \cup \{-\infty\})). \end{cases}$$

Finally, we also discuss some relevant cases where previous theorems are applicable. For example, we show the following homeomorphism for the c-boundary ∂V of de Sitter space $\mathbb{R} \times_{\cosh} \mathbb{S}^l$ multiplied by a complete Riemannian manifold (F, h_F) :

$$\partial V \equiv \left(\mathbb{S}^l \times (\mathcal{B}(F) \cup \{i^+\}) \right) \cup \left(\mathbb{S}^l \times (\mathcal{B}(F) \cup \{i^-\}) \right),$$

¹In here M^C denotes the Cauchy completion of the Riemannian manifold (M, h) and $B(M)$ denotes the space of the finite Busemann functions on M . See Chapter 2 for details.

where $\mathcal{B}(F)$ denotes the space of finite Busemann functions on (F, h_F) . In particular, if (F, h_F) is compact, then this reduces to:

$$\partial V \equiv (\mathbb{S}^l \times \{i^+\}) \cup (\mathbb{S}^l \times \{i^-\}).$$

CHAPTER 3. The purpose of this chapter is to study spacetimes with *(smooth) timelike boundary*, revisiting the properties of its causal ladder and focusing specially in its top level, that is, *globally hyperbolic spacetimes with timelike boundary*. This is a class of spacetimes firstly studied in Solís' thesis [95]. Notice that globally hyperbolic spacetimes (without boundary) can be characterized as those strongly causal spacetimes whose intrinsic *causal* boundary points (P, F) have no (conformal) naked singularities (i.e., they satisfy either $P = \emptyset$ or $F = \emptyset$, see below). In a natural way, the timelike boundary of our class of spacetimes contains the (conformal) naked singularities; moreover, its smoothness is the natural hypothesis in order to impose boundary conditions there. Chrusciel, Galloway and Solís [25] showed that a version of topological censorship holds in our class of spacetimes; notably, such a class include asymptotically anti-de Sitter ones.

Our results on the causal ladder include the following sharp characterizations for the interior V and boundary ∂V of the spacetime \bar{V} .

Theorem. (*Thm. 3.24*) *Let (\bar{V}, g) be a spacetime with timelike boundary.*

1. *If (\bar{V}, g) is causally continuous then it is stably causal. Moreover, $(V, g|_V)$ is causally continuous and $(\partial V, g|_{\partial V})$ is stably causal.*
2. *If (\bar{V}, g) is causally simple then it is causally continuous. Moreover, $(\partial V, g|_{\partial V})$ is causally simple too.*
3. *If (\bar{V}, g) is globally hyperbolic then it is causally simple. Moreover, $(\partial V, g|_{\partial V})$ is globally hyperbolic too.*

About globally hyperbolic spacetimes with timelike boundary, we will recover the celebrated topological splitting obtained by Geroch in the case without boundary [47]. So, we will show that such a spacetime admits a topological Cauchy splitting $\mathbb{R} \times \tilde{\Sigma}$ where $\tilde{\Sigma} = \Sigma \cup \partial\Sigma$ is an acausal Cauchy hypersurface with boundary $\partial\Sigma$. More precisely:

Theorem. *Any globally hyperbolic spacetime with timelike boundary (\bar{V}, g) admits a Cauchy time function t and it is homeomorphic to $\mathbb{R} \times \tilde{\Sigma}_0$, where $\tilde{\Sigma}_0$ is any Cauchy hypersurface with boundary.*

From the PDE viewpoint, this suggests that the Cauchy problem will be consistently well-posed in this class of spacetimes as a *mixed* Cauchy problem by providing not only the Cauchy data on $\tilde{\Sigma}$ ($\equiv \{0\} \times \tilde{\Sigma}$) but also boundary data on $\partial V \equiv \mathbb{R} \times \partial\Sigma$ (under suitable compatibility constraints at $\{0\} \times \partial\Sigma$). This would resemble the behavior of the elementary wave equation (see, for example, [42]). Background on this mixed problems has been developed by Valiente-Kroon in the monograph [64]; see also the recent article by Enciso and Kamran [32], as well as its expanded version [31]. Applications to wave equations and quantum field theory on curved spacetimes were obtained by Lupo [68, 67], extending works by Bär, Ginoux and Pfäffle [9], among others.

These results open natural new questions to explore, which will be studied in future research.

APPENDIX. Our preliminary study for these topics included also the *geodesic completeness* of certain Lorentzian manifolds. This issue is also related to the global structure of spacetimes as well as some alternative boundary constructions (namely, the geodesic and bundle ones).

The following result with value in its own right was obtained: *any compact manifold endowed with a linear connection such that the closure of its holonomy group is compact is geodesically complete (Thm. 1)*. In particular, it is applicable to the case when the linear connection is the Levi-Civita associated to a semi-Riemannian metric g . In the case that g is Riemannian, this recovers a well known consequence of Hopf-Rinow theorem (any compact Riemannian manifold is geodesically complete). When g is Lorentzian, it also provides an alternative proof to a recent result by Gutiérrez and Müller included in [53].

The results of the present memory have been collected in the scientific publications [4], [3], [1] and the paper in progress [2].

Background on Lorentzian Geometry and conventions

From now on, the symbols V , M will denote connected, Hausdorff, paracompact, second countable smooth manifolds. We will understand *smooth* as C^k -differentiable with $k \in \mathbb{N} \cup \{\infty\}$, $\mathbb{N} = 1, 2, \dots$, for the manifold and, consistently, for the metric and related tensors defined on the manifold. Given V , TV denotes the tangent bundle and T^*V is the cotangent bundle of V . Typically, Lorentzian metrics in V or M will be denoted by g and Riemannian metrics will be denoted by the letter h , all of them will be considered smooth.

Basic elements in Lorentzian Geometry

The following definitions and results are classical and can be found in [11, 61, 83, 101] and in the most recent work by Minguzzi and Sánchez [77].

Definition 1. A Lorentzian manifold is a smooth manifold V , of dimension $n \geq 2$, endowed with a non-degenerate metric $g : V \rightarrow T^*V \otimes T^*V$ of signature $(-, +, \dots, +)$.

In other words, g assigns in a differentiable way a non-degenerate scalar product g_p of signature $(-, +, \dots, +)$ on each tangent space T_pV for all $p \in V$. The non-degenerate metric g allows to distinguish tangent vectors in TV as follows:

Definition 2. A tangent vector $v \in TV$ is classified as:

- timelike if $g(v, v) < 0$.
- lightlike if $g(v, v) = 0$ and $v \neq 0$.
- causal if $g(v, v) \leq 0$ and $v \neq 0$.
- null if $g(v, v) = 0$.
- spacelike if $g(v, v) > 0$.
- non-spacelike if $g(v, v) \leq 0$.

Previous definition can be extended to vector fields $X \in \mathfrak{X}(V)$ as well, so, we can talk about timelike (resp. lightlike, causal, null, spacelike, non-spacelike) vector fields in a Lorentzian manifold (V, g) . Also, previous definition can be extended to smooth curves as follows: if $\gamma : I \subset \mathbb{R} \rightarrow V$ ($I = (a, b)$ and $-\infty \leq a \leq b \leq +\infty$) is a smooth curve, then, $\gamma(t)$ is timelike (resp. lightlike, causal, null, spacelike, non-spacelike) if its tangent vector $\gamma'(t)$ is timelike (resp. lightlike,

causal, null, spacelike). We say that γ connects p and q if $I = [a, b]$ ($a, b \in \mathbb{R}$) and $\gamma(a) = p$ and $\gamma(b) = q$.

One important feature to note is that at each point $p \in V$ the causal vectors in $T_p V$ are contained in a double cone with two connected components C_1 and C_2 . A *time-orientation* at p is a selection of one of these components in $T_p V$, the selected one will be called the *future cone* C^+ and the other one *past cone* C^- . If this selection can be made in a continuous way all over the Lorentzian manifold (V, \mathfrak{g}) , then, the Lorentzian manifold (V, \mathfrak{g}) is called *time-orientable*. The following characterization of time-orientable Lorentzian manifolds is classical and its proof can be found in [83, Lemma 5.32]:

Lemma 3. *A Lorentzian manifold (V, \mathfrak{g}) is time-orientable if and only if there exists a smooth timelike vector field $X \in \mathfrak{X}(V)$.*

When (V, \mathfrak{g}) is time-orientable, any of the globally defined timelike vector field $X \in \mathfrak{X}(V)$ fixes a time orientation in V , i.e., at each point $p \in V$ the future causal cone in $T_p V$ is the one that contains X_p . Therefore, the timelike vector field X can be defined as future-directed and at each $p \in V$ a causal tangent vector $v_p \in T_p V$ is called future-directed if and only if $\mathfrak{g}_p(v_p, X_p) < 0$, this is, v_p is in the same causal cone as X_p , and, v_p is past-directed if and only if $\mathfrak{g}_p(v_p, X_p) > 0$. Fixed such a time-orientation, the Lorentzian manifold is called time-oriented.

Definition 4. *A spacetime is a (connected) time-oriented Lorentzian manifold (V, \mathfrak{g}) .*

The hypothesis of being connected implies that only two time orientations are possible; it will be assumed except if otherwise is said explicitly. Classically, points in the spacetime are called *events*. Once we have a time-orientation in (V, \mathfrak{g}) we can define future-directed timelike (resp. causal) curves as follows: a smooth curve $\gamma : I \rightarrow V$ is called future-directed (resp. past-directed) timelike (resp. causal) if and only if $\gamma'(t)$ is timelike (resp. causal) and future-directed (past-directed) in the chosen time orientation of V . If a future-directed causal curve $\gamma : I \rightarrow V$ satisfies that $\lim_{t \rightarrow b} \gamma(t) = q$ (resp. $\lim_{t \rightarrow a} \gamma(t) = p$), where a, b are the extreme points of I , q is called a future endpoint of γ (resp. p is called a past-endpoint of γ). A causal curve without future (resp. past) endpoint is called future (resp. past) inextendible. Now, we have the tools to define the causality relations between events in a spacetime:

Definition 5. *Given a spacetime (V, \mathfrak{g}) , a pair of events (p, q) of V are :*

- Chronologically related, $p \ll q$, if there exists a future-directed timelike curve that connects p and q .
- Strictly causally related, $p < q$, if there exists a future-directed causal curve connecting p and q .
- Causally related, $p \leq q$, if either $p < q$ or $p = q$.
- Horismotically related, $p \rightarrow q$, if $p \leq q$ but $p \not\ll q$ (they are causally but not chronologically related).

With the above relations the *chronological past* and *future* of an event $p \in V$ are defined as $I^-(p) = \{q \in V \mid q \ll p\}$ and $I^+(p) = \{q \in V \mid p \ll q\}$. The *causal past* and *future* of an event $p \in V$ are defined as $J^-(p) = \{q \in V \mid q \leq p\}$ and $J^+(p) = \{q \in V \mid p \leq q\}$. For general subsets $A \subset V$ the future/past chronological/causal subsets $I^\pm(A)$ and $J^\pm(A)$ are analogously defined. The following properties are well known (see [11, Chapter 3]):

Proposition 6. *Let (V, \mathfrak{g}) be a spacetime, then:*

- For any $p, q, r \in V$, $p \ll q \leq r \Rightarrow p \ll r$, $p \leq q \ll r \Rightarrow p \ll r$.
- The subsets $I^+(p)$ and $I^-(p)$ are open for any $p \in V$.
- $J^\pm(p) \subset cl(I^\pm(p))$ (here $cl(\cdot)$ denotes the topological closure) for any $p \in V$.
- $I^\pm(p) = Int(J^\pm(p))$ (here $Int(\cdot)$ denotes the topological interior) for any $p \in V$.

It is worth mentioning that the chronological and causal relations between events in the spacetime can be defined by using piecewise smooth curves, the only extra condition we have to ask for these kind of curves is that at each break the lateral tangent vectors are in the same causal cone. No generality is obtained if we define the causal relations between events using smooth or piecewise smooth causal curves. The space of piecewise smooth causal curves is convenient for most purposes; however, it is not big enough, especially for questions on convergence of causal curves. For example, the so-called *limit curves* of sequences of piecewise smooth causal curves are not necessarily smooth. Therefore, the extension of causal curves in the definition below will be required.

Recall first that any point p of a semi-Riemannian manifold admits a *normal* neighborhood U (i.e., the exponential map at p , \exp_p , is defined on some starhaped neighborhood of $0 \in T_p M$ which is mapped diffeomorphically onto U) which can be chosen (*normal*) *convex* (i.e. U is a normal neighborhood of all its points). The existence of convex neighbourhoods rely only on the Levi-Civita connection and holds for all linear connections [86, Props. 1.2 and 1.3].

Definition 7. A (continuous) curve $\gamma : I \rightarrow V$ is a future-directed continuous causal curve at $t_0 \in I$ if for any convex neighbourhood $U \ni \gamma(t_0)$ and any interval $G \subset I$, $t_0 \in G$, such that $\gamma(G) \subset U$ one has: if $t' \in G$ and $t' < t_0$ (resp. $t_0 < t'$) then $\gamma(t') <_U \gamma(t_0)$ (resp. $\gamma(t_0) <_U \gamma(t')$), where $<_U$ denotes the strict causal relation regarding U a spacetime.

So, chronological and causal relations between events in the spacetime can be defined by using continuous causal curves, even though no generality is obtained when we use these curves in these definitions instead of the more regular piecewise smooth ones. Even more, although continuous causal curves are not necessarily differentiable, they have a high degree of regularity. In fact, in [19, Appendix A, Thm. A.1] the authors give the following characterization.

Theorem 8. Let (V, g) be a spacetime and $\gamma : [a, b] \rightarrow V$ continuous. The curve γ is future-directed continuous causal if and only if γ is locally H^1 (that is, locally absolutely continuous for some and, then, any auxiliary Riemannian metric), up to a reparametrization, and $\gamma'(s)$ is a future-directed causal vector almost everywhere in I .

The causal hierarchy of spacetimes

In [77] the authors give a detailed description of the *causal hierarchy* of spacetimes and they provide a number of characterizations for each stage. Here, we will give only the basics definitions of the main levels of the causal hierarchy. Each level corresponds with a causality condition on the spacetime (V, g) which is strictly more restrictive than the previous one:

Definition 9. A spacetime (V, g) is:

- (i) Non-totally vicious if there exists a point $p \in V$ that is not chronologically relate to itself, $p \not\ll p$.
- (ii) Chronological if it does not contain closed timelike curves.
- (iii) Causal if it does not contain closed causal curves.

- (iv) Distinguishing if whenever $I^+(p) = I^+(q)$ or $I^-(p) = I^-(q)$, necessarily $p = q$.
- (v) Strongly causal if it does not contain “almost closed” causal curves, i.e. for any open neighborhood U of p there exists some open neighborhood V with $p \in V \subset U$ such that any causal segment with endpoints at V is contained in U .
- (vi) Stably causal if there exists some causal Lorentzian metric g' on V with $g < g'$, i.e., such that $g'(v, v) < 0$ for any $v \in TV \setminus \{0\}$ with $g(v, v) \leq 0$.
This is equivalent to the existence of some global time function (i.e., a function defined on the whole spacetime (V, g) which is strictly increasing along each future-directed causal curve) as well as to the existence of a temporal function (i.e., a smooth function with past-directed timelike gradient everywhere).
- (vii) Causally continuous if it is distinguishing and the set valued functions $I^+(\cdot)$ and $I^-(\cdot)$ are outer continuous (recall, $I^+(\cdot)$ is outer continuous at some $p \in V$ if, for any compact subset $K \subset I^+(p)$ there exists an open neighborhood $U \ni p$ such that $K \subset I^+(q)$ for all $q \in U$).
This is equivalent to being distinguishing and reflecting, i.e. for any pair of events $p, q \in V$, $I^+(q) \subset I^+(p)$ if and only if $I^-(p) \subset I^-(q)$.
- (viii) Causally simple if it is causal and $J^\pm(p)$ are closed sets for any $p \in V$.
- (ix) Globally hyperbolic if it is strongly causal and $J^+(p) \cap J^-(q)$ are compact for any $p, q \in V$.

Now, we will give a brief description of the most relevant results concerning to the last stage of the causal hierarchy. One important characterization for globally hyperbolic spacetimes was obtained by R. Geroch in the seminal paper [47]. In order to give this characterization, first let us recall that a subset $A \subset V$ is called *achronal* (*acausal*) if the relation $p \ll q$ ($p \leq q$) never holds for points $p, q \in A$, this means, that no timelike (resp. causal) curve meets A more than once. A Cauchy hypersurface in V is a subset $\Sigma \subset V$ such that it is intersected only once by any inextendible timelike curve. The characterization of globally hyperbolic spacetimes in terms of Cauchy hypersurfaces is given now (see [77, Thm. 3.75]):

Theorem 10. (V, g) is globally hyperbolic if and only if it admits a Cauchy hypersurface Σ . Even more, (i) (V, g) admits a Cauchy time function t (a continuous time function such that each level hypersurface $t^{-1}(a) = \Sigma_a$ is a Cauchy hypersurface) and (ii) all Cauchy hypersurfaces are homeomorphic to Σ , and V is homeomorphic to $\mathbb{R} \times \Sigma$.

Such results will be extended to the case with timelike boundary in Chapter 3. It is worth pointing out that, after Geroch’s result, obvious questions about the smoothability of the Cauchy hypersurface Σ and the Cauchy time function were posed. The answer was not obtained until the works by Bernal and Sánchez [13, 14]:

Theorem 11. Any globally hyperbolic spacetime (V, g) :

- (i) admits a smooth spacelike Cauchy hypersurface Σ_0 ; as a consequence it is diffeomorphic to $\mathbb{R} \times \Sigma_0$ (and all the smooth Cauchy hypersurfaces are diffeomorphic), and
- (ii) admits a Cauchy temporal function, that is, a temporal function such that all its slices are (necessarily smooth, spacelike) Cauchy hypersurfaces; as a consequence, it is globally isometric to a smooth orthogonal product manifold $\mathbb{R} \times \Sigma$ with metric tensor $g \equiv -\Lambda d\tau^2 + h_\tau$, where $\Lambda : \mathbb{R} \times \Sigma \rightarrow \mathbb{R}$ is a positive smooth function, $\tau : \mathbb{R} \times \Sigma \rightarrow \mathbb{R}$ the natural projection, each level at constant τ , Σ_τ , is a spacelike Cauchy hypersurface, and h_τ is a Riemannian metric on each Σ_τ , which varies smoothly with τ .

The ideas in that method have shown to be very flexible for a variety of problems [15, 77, 81, 79, 78]. However, different smoothability procedures have been developed in order to construct Cauchy temporal functions since then, namely: Fathi and Siconolfi [33] using methods inspired from weak-KAM theory valid for continuous cone structures, Chrusciel, Grant and Minguzzi [26] (see also [76]), using methods inspired from Seifert's [94] approach to smoothability in spacetimes, and Bernard and Suhr [17], using methods inspired from Conley theory valid for possibly non-continuous closed cone structures.

The celebrated results by Choquet-Bruhat [23] and Choquet-Bruhat and Geroch [24] ensure that globally hyperbolic spacetimes are determined by Cauchy data on a Cauchy hypersurface Σ , where such data are naturally provided by the metric on Σ and its second fundamental form, both under the constraints inherent to the Gauss and Codazzi equations. The existence of a smooth and spacelike Cauchy hypersurface Σ for any globally hyperbolic spacetime V ensures the well-posedness of the Cauchy problem. Moreover, the existence of a splitting for the full spacetime V as a orthogonal product $(\mathbb{R} \times \Sigma, g = -\Lambda d\tau^2 + g_\tau)$, where τ is a Cauchy temporal function, shows the consistency of the notion of predictability from each "instant" of time to another (apart from implying many practical advantages). A full and self-contained development of the Cauchy problem has been carried out recently in the book by Ringström [88].

Background on the c-completion

The *causal completion* was firstly introduced by Geroch, Kronheimer and Penrose in their seminal work [48]. The rough idea for such a construction was to attach an *ideal point* to any future or past inextendible timelike curve, being such a point characterized by the past or future of the curve, respectively. This construction is carried out so that each inextendible timelike curve in the spacetime has an endpoint in the new space. As the construction only depends on the causality of the spacetime, then, the causal completion is conformally invariant. The original construction contained several problems, mainly related to the topology to be considered. However, the notion of causal boundary and completion have been widely developed since then [18, 54, 55, 87, 98, 99] (see also the reviews in [46, 92]), reaching at a fully transparent definition for the causal completion (named *c-completion*) in [35].

Let (V, g) be a spacetime. In the framework of the c-boundary, it will always be taken strongly causal. So, its *Alexandrov topology* (generated by the intersections between the chronological future and past of all the pairs of points) is equal to the topology in V . In particular, strong causality ensures that V is also distinguishing, hence, two different points $p, q \in V$ will have both, different chronological futures $I^+(p) \neq I^+(q)$ and pasts $I^-(p) \neq I^-(q)$.

A non-empty subset $P \subset V$ is called a *past set* if it coincides with its past, i.e., $P = I^-(P) := \{p \in V : p \ll q \text{ for some } q \in P\}$. Let $S \subset V$ and define the *common past* of S as $\downarrow S := I^-(\{p \in V : p \ll q \forall q \in S\})$. Observe that, from definition, the past and common past sets are open. A past set that cannot be written as the union of two proper past sets is called *indecomposable past set*, *IP* for short. An indecomposable past set P belongs to one of the following two categories: P can be expressed as the past of a point of the spacetime, i.e., $P = I^-(p)$ for some $p \in V$, and so, P is called *proper indecomposable past set*, *PIP* for short; or $P = I^-(\{x_n\}_n)$ for some inextendible future-directed chronological sequence² $\{x_n\}_n$, and then P is called *terminal indecomposable past set*, *TIP* for short. The dual notions of *future set*, *common future*, *IF*, *PIF* and *TIF*, are defined just by interchanging the roles of past and future in previous definitions.

The *future causal completion* is defined as the set of all indecomposable past sets. As the manifold V is distinguishing, the original manifold points $p \in V$ are naturally identified with

²Here, by a future-directed chronological sequence $\{x_n\}_n$ we mean that $x_n \ll x_{n+1}$ for all n , see [34] for details on this approach to the c-boundary.

their past $p \equiv I^-(p)$, and so, V is identified with the set of PIPs. Therefore, the *future causal boundary* $\hat{\partial}V$ is defined as the set of all TIPs in V , obtaining the following identifications:

$$V \equiv \text{PIPs}, \quad \hat{\partial}V \equiv \text{TIPs}, \quad \hat{V} \equiv \text{IPs}.$$

The future causal completion \hat{V} will be endowed with the *future chronological topology* $\hat{\tau}_{chr}$, a sequential topology defined by the following limit operator: for $\sigma = \{P_n\}_n \subset \hat{V}$,

$$P \in \hat{L}_{chr}(\{P_n\}_n) \iff P \subset \text{LI}(\{P_n\}_n) \text{ and it is maximal in } \text{LS}(\{P_n\}_n). \quad (3)$$

Here by maximal we mean that no other $P' \in \hat{V}$ satisfies the stated property and strictly includes P . The symbols LS and LI denote superior and inferior limits for sets resp., which are defined in the following way: given a sequence $\{A_n\}_n$ of sets,

$$\text{LI}(\{A_n\}_n) = \bigcup_{m=1}^{\infty} \bigcap_{n=m}^{\infty} A_n \quad \text{LS}(\{A_n\}_n) = \bigcap_{m=1}^{\infty} \bigcup_{n=m}^{\infty} A_n.$$

Analogously, we define the *past causal completion* by interchanging the roles of future and past sets. Hence we obtain the following identifications:

$$V \equiv \text{PIFs}, \quad \check{\partial}V \equiv \text{TIFs}, \quad \check{V} \equiv \text{IFs}.$$

Moreover, \check{V} is endowed with the *past chronological topology* $\check{\tau}_{chr}$ defined by a limit operator \check{L}_{chr} as follows: for $\sigma = \{F_n\}_n \subset \check{V}$,

$$F \in \check{L}_{chr}(\{F_n\}_n) \iff F \subset \text{LI}(\{F_n\}_n) \text{ and it is maximal in } \text{LS}(\{F_n\}_n). \quad (4)$$

Again, maximal means here that no other $F' \in \check{V}$ satisfies the stated property and strictly includes F .

In order to construct the (total) c-completion, we need to recall that some IPs and IFs represent naturally the same point of the completion. This is quite evident for PIPs and PIFs, where future and past sets can be identified if they are future and past of the same point respectively. However, the previous identification is not sufficient, as other indecomposable sets have to be identified. For this, let us define the so-called *Szabados-relation* or S-relation for short (introduced in [98]). Denote by $\hat{V}_{\emptyset} = \hat{V} \cup \{\emptyset\}$ and by $\check{V}_{\emptyset} = \check{V} \cup \{\emptyset\}$. The S-relation \sim_S is defined in $\hat{V}_{\emptyset} \times \check{V}_{\emptyset}$ as follows. First, a pair $(P, F) \in \hat{V} \times \check{V}$ satisfies

$$P \sim_S F \iff \begin{cases} P & \text{is included and is a maximal IP into } \downarrow F \\ F & \text{is included and is a maximal IF into } \uparrow P. \end{cases} \quad (5)$$

Here by maximal we mean that no other $P' \in \hat{V}$ ($F' \in \check{V}$) satisfies the stated property and strictly includes P (resp. F). As proved by Szabados [98], the past and future of a point $p \in V$ are S-related, $I^-(p) \sim_S I^+(p)$, and these are the unique S-relations (according to our definition (5)) involving proper indecomposable sets. Then, we also define $P \sim_S \emptyset$ (resp. $\emptyset \sim_S F$) if P (resp. F) is a non-empty, necessarily terminal indecomposable past (resp. future) set that is not S-related by (5) to any other indecomposable set (note that \emptyset is never S-related to itself).

Now, we are in conditions to introduce the notion of c-completion at the point set level, according to [35] and [72]:

Definition 12. *The c-completion \bar{V} of a strongly causal spacetime V is formed by all the pairs $(P, F) \in \hat{V}_{\emptyset} \times \check{V}_{\emptyset}$ with $P \sim_S F$. The c-boundary ∂V is defined as $\partial V := \bar{V} \setminus V$, under the identification $V \equiv \{(I^-(p), I^+(p)) : p \in V\}$.*

The boundary points can be classified in three different classes, that we will define now for future reference (see Chapter 1).

Definition 13. Let $(P, F) \in \partial V$ be an arbitrary point on the c -boundary. We will say that (P, F) is a timelike boundary point if both components are non empty $P \neq \emptyset \neq F$. The point is a lightlike boundary point if one of the components is empty and, in the case $P \neq \emptyset$ (resp. $F \neq \emptyset$) there exists P' (resp. F') a proper indecomposable set such that $P \subsetneq P'$ (resp. $F \subsetneq F'$). Finally, in the remaining case, a terminal set P (resp. F) not contained in any other IP (resp. IF), is a spatial boundary point³.

The chronological relation on V is also extended to the c -completion in the following way (by a slight abuse of notation, we denote the chronological relation on \bar{V} with the same symbol \ll): given two points $(P, F), (P', F') \in \bar{V}$

$$(P, F) \ll (P', F') \iff F \cap P' \neq \emptyset. \quad (6)$$

It is worth pointing out that the definition of the causal relation on the c -completion would be subtler (recall [35, Section 3.5]) even though it is well-known that any chronological relation has a naturally associated causal relation \leq (see [77, Defn. 2.22] for details). Remarkably, in the particular case of *multiwarped spacetimes* (to be studied in the Chapter 2 of this thesis), the following criterium suffices (see the discussion in [37, Sect. 6.4], and references therein, for further details). Given two points $(P, F), (P', F') \in \bar{V}$ with, either $P \neq \emptyset$ or $F' \neq \emptyset$:

$$P \subset P' \text{ and } F' \subset F \Rightarrow (P, F) \leq (P', F')$$

(again, the symbol \leq is also used in the completion). Moreover, in this case, we will say also that two different pairs in \bar{V} are *horismotically related* if they are causally but not chronologically related.

Remark 14. Now that we have defined the chronological relation in \bar{V} , we can understand better the terminology introduced in Defn. 13. Clearly, if a boundary point (P, F) is timelike (and so, with both components non empty), then (P, F) lies in the past (resp. future) of any point $y \in F$ (resp. $y \in P$). Otherwise, either P or F should be empty, so, let us assume $F = \emptyset$ (the other case will be analogous). Observe that if (P, \emptyset) is a lightlike point, then there exists another point $(P', F') \in \bar{V}$ with $P \subsetneq P'$. It is clear that previous points $((P, \emptyset)$ and (P', F')) cannot be timelike related according to (6), however it follows that $(P, \emptyset) \leq (P', F')$ (according to [37, Section 6.4]), being natural to assume that both points are horismotically related. Finally, if (P, \emptyset) is a spatial boundary point, then no pair $(P', F') \in \bar{V}$ will satisfy that $(P, \emptyset) \leq (P', F')$.

Finally, \bar{V} is endowed with the *chronological topology* τ_{chr} , the sequential topology associated to the following limit operator L_{chr} (known as the chronological limit). For any sequence $\sigma = \{(P_n, F_n)\}_n \subset \bar{V}$, define

$$L_{chr}(\sigma) := \left\{ (P, F) \in \bar{V} : \begin{array}{l} P \in \hat{L}_{chr}(\{P_n\}_n) \text{ if } P \neq \emptyset \\ F \in \check{L}_{chr}(\{F_n\}_n) \text{ if } F \neq \emptyset \end{array} \right\}. \quad (7)$$

Remark 15. If $(P, F) \in L(\{(P_n, F_n)\}_n)$ then $\{(P_n, F_n)\}_n$ converges to (P, F) in τ_{chr} . However, the opposite is not always true (see [38, Example A.4]). We will say that L is a *first order operator* for $\{(P_n, F_n)\}_n$ if previous notions are equivalent for $\{(P_n, F_n)\}_n$. L is a *first order operator* on \bar{V} if the first order condition is satisfied for every sequence $\{(P_n, F_n)\}_n \subset \bar{V}$.

It is important to recall (and it will be used later) that, due the definition of the S-relation between terminal sets, the definition of the chronological limit is simplified when both terminal sets on the limit are non empty (see [35, Lemma 3.15]). Concretely:

³Observe that the definition of spatial point makes sense also for partial boundaries. In fact, in the case of the future completion \hat{V} , an IP $P \in \hat{V}$ is a spatial point if there is no $P' \in \hat{V}$ such that $P \subsetneq P'$. The definition for the future causal completion is analogous.

Proposition 16. *Let $\{(P_n, F_n)\}_n$ be a sequence of pairs in \bar{V} and assume that $P \sim_S F$ with $P \neq \emptyset \neq F$. If $P \subset LI(\{P_n\}_n)$ and $F \subset LI(\{F_n\}_n)$ then $(P, F) \in L_{chr}(\{(P_n, F_n)\}_n)$.*

The following result will summarize the main properties of the c-completion endowed with the chronological relation and topology (see [35, Thm. 3.27] and its proof).

Theorem 17. *Let (V, g) be a strongly causal Lorentzian manifold and \bar{V} its causal completion endowed with the chronological structure induced by (6) and the topology induced from the chronological limit (7). Then:*

- (i) *The inclusion $V \hookrightarrow \bar{V}$ is continuous. Moreover, the restriction of the chronological limit on V is a first order limit operator.*
- (ii) *Let $\{x_n\}_n \subset V$ be a future (resp. past) chronological sequence. Then,*

$$L_{chr}(\{x_n\}_n) = \{(P, F) \in \bar{V} : P = I^-(\{x_n\}_n) \text{ (resp. } F = I^+(\{x_n\}_n)\}$$
- (iii) *The c-completion is complete: For any past terminal set P (resp. future terminal set F) there exists F (resp. P) such that $(P, F) \in \bar{V}$. In particular, any inextensible timelike curve γ on V has an endpoint in \bar{V} .*
- (iv) *The sets $I^\pm((P, F))$ are open for all $(P, F) \in \bar{V}$.*
- (v) *\bar{V} is a T_1 topological space.*

Moreover, globally hyperbolic spacetimes can be characterized in terms of the c-boundary [35, Theorem 3.29].

Theorem 18. *A strongly causal spacetime is globally hyperbolic if and only if all the pairs (P, F) of its c-boundary satisfy either $P = \emptyset$ or $F = \emptyset$.*

Anyway, there are several subtleties involving the definition of the c-boundary which are essentially associated to the following facts: on one hand, a TIP (or TIF) may not determine a unique pair in the c-boundary, i.e. we can have $(P, F), (P, F') \in \partial V$, $F \neq F'$; on the other hand, the topology does not always agree with the S-relation, in the sense that, for S-related elements $P \neq \emptyset \neq F$:

$P \in \hat{L}(\{P_n\}_n)$ is not equivalent to $F \in \check{L}(\{F_n\}_n)$. This makes natural to consider the following special cases:

Definition 19. *A spacetime V has a c-completion \bar{V} which is simple as a point set if each TIP (resp. each TIF) determines a unique pair in ∂V . Moreover, the c-completion is simple if it is simple as a point set and also topologically simple, i.e. $(P, F) \in L(\{(P_n, F_n)\}_n)$ holds when either $P \in \hat{L}(\{P_n\}_n)$ or $F \in \check{L}(\{F_n\}_n)$.*

Relation with the conformal completion

Let us describe briefly the general construction of the *conformal boundary* following [35, Section 4].

A smooth map $i : V \hookrightarrow V_0$ between two Lorentzian manifolds $(V, g), (V_0, g_0)$ is called an *open embedding* if $i(V)$ is an open subset in V_0 and i is a diffeomorphism between V and its image $i(V)$. The map i is *conformal* if the pullback metric i^*g_0 satisfies $i^*g_0 = \Omega g$ for some function $\Omega > 0$ on V ; for spacetimes, we will also assume that the time-orientations are preserved. Notice that, eventually, $\{\Omega(p_n)\}_n$ may tend to 0 or ∞ when the sequence $\{i(p_n)\}_n$ converges to the

topological boundary of $i(V)$ in V_0 . This possibility becomes important for the metric properties in some cases, see, for example, the definition of asymptotic flatness in [101, Chapter 11]. However, we will not care about it, as we will consider only properties which are conformally invariant. Indeed, once i is defined, we are free to rescale g so that i becomes an isometry. An *open (conformal) envelopment* of V is an open conformal embedding $i : V \hookrightarrow V_0$ in some (“unphysical”) strongly causal spacetime V_0 .

Given an open envelopment, the *conformal completion* associated to i is just the closure $cl(i(V))$ of $i(V)$ in V_0 , endowed with the topology induced from V_0 . Thus, the corresponding *conformal boundary* is just $\partial_i V := cl(i(V)) \setminus i(V)$, also endowed with the induced topology. As stressed in [35, Remark 4.2] there are some different options to define the chronological and causal relations in the completion; this leads to several subtleties in order to relate this completion with the c -completion [35, Sections 4.2, 4.3].

Moreover, there are some natural properties which can be imposed to the conformal boundary $\partial_i V$, for example, to be C^1 (i.e., $cl(i(V))$ is a C^1 manifold with boundary $\partial_i V$) or to be *chronologically complete* (all future or past inextendible curves in $i(V)$ have an endpoint in $\partial_i V$). Unfortunately, such additional properties are incompatible in relevant cases. For example, the usual conformal boundary of Lorentz-Minkowski spacetime in the Einstein static universe is not C^1 [101, Section 11.1], and the usual conformal boundary of anti-de Sitter spacetime is not chronologically complete. However, the following result is worth pointing out [35, Thm. 4.32]:

Theorem 20. *Let (V, g) be globally hyperbolic. If it has a conformal boundary which is both C^1 and chronologically complete, then its conformal completion is equivalent to the causal one.*

Theorems 18 and 20 suggest the importance of globally hyperbolic spacetimes with (C^1 , conformal) *timelike* boundary, which will be studied in Chapter 3. The interior of such a spacetime is not globally hyperbolic, regarded as a spacetime without boundary. Nevertheless, its (conformal) naked singularities (which can be identified with the pairs (P, F) with no empty component by Theorem 18) admit naturally the C^1 structure provided by the conformal boundary. Thus, even when these two boundaries do not coincide completely (due to the subtleties pointed out above), the interplay between them exhibit a controlled nature for hyperbolic equations; this will be clear in the results of Chapter 3.

Finally, it is worth pointing out that Harris [58, 59] has obtained further properties about the differentiable structure of the causal boundary of some type of spacetimes. Also recently, Müller has obtained obstructions to the existence of the conformal boundary [82] as well as further applications of the causal boundary to horizons [80] (an issue that had been typically studied by using the conformal boundary).

Agradecimientos - Acknowledgments

Gracias a mis directores José Luis Flores Dorado y Miguel Sánchez Caja por su infinita paciencia y por guiarme en el camino de la investigación.

Muchas gracias a Jónatan Herrera Fernández por hacerme trabajar a las 2 a.m., fueron (y serán) momentos divertidos en mi vida.

A mis compañeros de despacho: Kiko, Oihana, Joni (Jónatan), Pepe, David y Alex (el nuevo), el orden es cronológico. Por los momentos divertidos, los cafés y las largas horas de frustración compartida (bueno, y algún que otro momento de Eureka).

A mis padres Maria Fidelia Hau Kaul y Luis Antonio Aké Ek. Muchas gracias por su comprensión y cariño. También agradezco a mis hermanas Diana y Natalia por aguantarme muchos años (salvo el período 2014-2018).

Gracias al Consejo Nacional de Ciencia y Tecnología (CONACyT) por el apoyo otorgado para la realización de mis estudios de doctorado.

Spacetime coverings and the c-boundary

In this chapter we will study the relation between the c-completion of a Lorentz manifold V and its quotient $M = V/G$, where G is an isometry group acting freely and properly discontinuously. In section 1.1, we study the properties of sequential topologies and limit operators, recalling well known properties and establishing new ones. In section 1.2, we consider the future causal completion case, characterizing when such a quotient is well behaved with the future chronological topology. In section 1.3, we show that under some general assumptions, there exists a homeomorphism and chronological isomorphism between some adequate quotient of the c-completion of V (defined by G) and the c-completion of M . In Section 1.4 we include several technical examples showing the optimality of our results. Finally, in section 1.5, we give a practical application by considering isometric actions over Robertson-Walker spacetimes, including in particular the Anti-de Sitter model.

1.1 Sequential topologies and limit operators

Along this section we will include all the basic facts about *sequential topologies* and *limit operators* that we will require. Most of the results are known (see [36, 38]), but we present the concept of *first order UTS* along some associated results that, as far as we known, are new. Also, at the end of this section we will give basic results on quotient spacetimes and the relation between the chronology of a spacetime and its quotient (Subsection 1.1.1).

Let X be an arbitrary space with a limit operator L defined on it, that is, an operator $L : \mathcal{S}(X) \rightarrow \mathcal{P}(X)$, where $\mathcal{S}(X)$ is the space of sequences in X and $\mathcal{P}(X)$ is the space of parts of X . We will always assume that the limit operator is: (a) *coherent*, and so, $L(\sigma) \subset L(\kappa)$ where $\kappa, \sigma \in \mathcal{S}(X)$ and κ is a subsequence of σ (this will be denoted by $\kappa \subset \sigma$); and (b) *finite-invariant* ensuring that $L(\sigma) = L(\kappa)$ if a common subsequence is obtained by deleting a finite number of terms in both sequences.

Any (coherent and finite-invariant) limit operator defines naturally a topology τ_L on X on the following way: a set C is closed for τ_L if and only if $L(\sigma) \subset C$ for all sequences $\sigma \subset C$. Such a topology is *sequential*, i.e., it is completely determined by the convergence of its sequences (a subset is closed if and only if it contains all its convergent sequences); this happens even if $L(\sigma)$ only determines some of the possible limits of σ . Reciprocally, any sequential topology τ has associated a limit operator L_τ (its usual convergence) such that $\tau = \tau_{L_\tau}$ (see [38, Prop. 2.6]).

Observe however that the previous limit operator does not uniquely determine τ . Among the limits defining a concrete sequential topology τ , it is always possible to choose one satisfying that $p \in L(\{p\}_n)$, where $\{p\}_n$ denotes the constant sequence p . In the particular case when $\{p\} = L(\{p\}_n)$, we will say that the limit operator is *idempotent*. Finally, the pair (X, L) will also represent the sequential topological space (X, τ_L) .

In general, the limit operator L does not determine the complete set of convergence points of a sequence σ with the topology τ_L . In fact, the only implication which is always true is that:

$$p \in L(\sigma) \implies \sigma \text{ converges to } p \text{ with the topology } \tau_L. \quad (1.1)$$

When the reciprocal implication is satisfied for all sequences, we will say that the limit operator is *of first order*. In general, there are not many results that allows us to determine when a limit operator is of first order. In fact, in practical cases, the proof is done case by case, taking special care of “problematic” sequences. However, if we relax slightly the first order condition on L , we can obtain simply-to-check conditions which will be enough for our purposes. In this sense, let us introduce some definitions.

Definition 1.1. *Let X be a space and L a limit operator defined on X . Let us denote by τ_L the associated sequential topology and let $\sigma \subset X$ be a sequence. We will say that L is of first order for σ if*

$$p \in L(\sigma) \iff \sigma \text{ converges to } p \text{ with the topology } \tau_L.$$

Additionally, we will say that L is of first order up to a subsequence for σ (or first order UTS for short), if σ has a subsequence $\kappa \subset \sigma$ such that L is of first order for κ . Finally, we will say that L is of first order UTS if it is of first order UTS for all sequences $\sigma \subset X$.

The following result gives us a sufficient condition to ensure when a limit operator is of first order for a given sequence.

Lemma 1.2. *Consider (X, L) a sequential space with L idempotent. Let σ be a sequence on X such that, for all subsequence $\kappa \subset \sigma$, $L(\kappa) = L(\sigma)$. Assume additionally that $L(\sigma)$ only contains a finite number of elements. Then, $cl(\sigma) = \sigma \cup L(\sigma)$, where $cl(\sigma)$ denotes the topological closure of σ . In particular, L is of first order for σ .*

Proof. The proof is quite straightforward and we include it here for the sake of completeness. Observe that the set $C = \sigma \cup L(\sigma) \subset cl(\sigma)$ from (1.1), so the first assertion follows if we prove that C is closed. For this, let $\kappa \subset C$ and let us prove that $L(\kappa) \subset C$. Recall that, due to the finite number of elements in $L(\sigma)$, we have two possibilities (up to a subsequence) for $\kappa \subset C$: Or the sequence κ is a subsequence of σ , and so, $L(\kappa) = L(\sigma) \subset C$; or κ is constantly an element $p \in C$, and so, $L(\kappa) = \{p\} \subset C$. In both cases, $L(\kappa) \subset C$ and hence C is closed.

For the last assertion, that is, the first order character of L on σ , let us assume that $\sigma \rightarrow p$. Again, we distinguish two cases:

- We can exclude a finite number of elements in σ such that the refined sequence σ' does not contain p . As we are removing only a finite number of elements, $L(\sigma') = L(\sigma)$ and it follows from the first assertion that $cl(\sigma') = \sigma' \cup L(\sigma')$. As $\sigma' \rightarrow p$, we have that $p \in \sigma' \cup L(\sigma')$. From construction σ' does not contain p , so $p \in L(\sigma') = L(\sigma)$.
- Otherwise, we can construct a subsequence κ of σ with $\kappa = \{p\}_n$. In particular, $p \in L(\{p\}_n) = L(\kappa) = L(\sigma)$ (recall that the last equality follows by hypothesis).

In conclusion, $p \in L(\sigma)$ and L is of first order for σ . □

The previous result gives us a relatively simple way to determine when L is of first order for a given sequence σ (and so, to determine when L is of first order) and it is usually enough in particular cases. However, we can go a step further on the search of a easily verifiable condition. For this, let us note that most of the results we will present on this chapter require, not a complete control of the convergence of sequences, but the existence for any sequence of a subsequence sufficiently well behaved. This is made apparent in the following result which ensures continuity of a map between sequential spaces:

Proposition 1.3. *Let $f : (M, L) \rightarrow (N, L')$ be a map between sequential spaces (M, L) and (N, L') . The map f is continuous if for any sequence $\{p_n\}_n \subset M$ and $p \in L(\{p_n\}_n)$ there exists a subsequence $\{p_{n_k}\}_k$ of $\{p_n\}_n$ such that $f(p) \in L'(\{f(p_{n_k})\}_k)$.*

Proof. Let C be a closed set in (N, L') , and let us show that $f^{-1}(C)$ is closed on (M, L) . Assume by contradiction that $f^{-1}(C)$ is not closed and so, from definition, that there exists a sequence $\sigma \subset f^{-1}(C)$ and a point $p \in M$ with $p \in L(\sigma) \setminus f^{-1}(C)$. From hypothesis, there exists a subsequence $\kappa \subset \sigma$ such that $f(p) \in L'(f(\kappa))$. But $f(\kappa) \subset C$, which is closed for the topology $\tau_{L'}$. Therefore $f(p) \in C$, and so, $p \in f^{-1}(C)$, a contradiction. \square

This is one of the reasons why the condition of L being of first order UTS is specially interesting for us. This condition is quite technical. However, the following simple criterium will be enough in practical cases:

Lemma 1.4. *Let X be any space with an idempotent limit operator L defined on it. Assume that $\#L(\bar{\sigma}) < \infty$ for all sequences $\bar{\sigma} \subset X$. Then, L is of first order UTS¹.*

Proof. Let $\sigma \subset X$ be an arbitrary sequence. Observe that there are two possibilities for the sequence:

- (a) for all subsequences $\kappa \subset \sigma$, $L(\kappa) = L(\sigma)$ or
- (b) there exists $\kappa_1 \subset \sigma$ with $L(\sigma) \subsetneq L(\kappa_1)$. In particular, $\#L(\kappa_1) \geq \#L(\sigma) + 1$.

In the first case, L is of first order for σ according to Lemma 1.2 and we are done. In the second case, we can repeat the same argument with κ_1 on the role of σ . Again there are two possibilities: either it ends in a finite number of iterations with a sequence κ_{n_0} satisfying previous (a), hence, with L being of first order for κ_{n_0} ; or we obtain a chain of subsequences

$$\kappa_1 \supset \kappa_2 \supset \dots \supset \kappa_n \supset \dots$$

with $\#L(\kappa_{i+1}) \geq \#L(\kappa_i) + 1$. However, this second possibility will lead us to the existence of a sequence with infinite limits, a contradiction. In fact, if $\kappa_i = \{x_n^i\}_n$ then the diagonal sequence $\{x_n^n\}_n$ satisfies:

$$\cup_i L(\kappa_i) \subset L(\{x_n^n\}_n),$$

which implies that $\#L(\{x_n^n\}_n) = \infty$ due the increasing character of $\#L(\kappa_i)$. In conclusion, the previous inductive process should end in a finite number of steps, obtaining a subsequence of σ where L is of first order. \square

¹We would like to thanks Prof. S. Harris who made us aware of this improvement for a previous version of the result.

Finally, let us review how sequential topologies behave under a quotient. As it was proved on [36, Rem. 5.12], given a sequential space (X, L) and an equivalence relation \sim defined on it, the quotient topological space X/\sim (with the induced topology) is again a sequential space. In fact, it is possible to give explicitly a limit operator L_Q whose associated topology coincides with the quotient topology in X/\sim in the following way:

$$[x] \in L_Q(\{[x_n]\}_n) \iff \exists x' \in i^{-1}([x]), x'_n \in i^{-1}([x_n]) \forall n \in \mathbb{N} : x' \in L(\{x'_n\}_n). \quad (1.2)$$

where $i : X \rightarrow X/\sim$ is the natural quotient projection and $[x], [x_n] \in X/\sim$. As it happens in the general case of topological spaces, the quotient topology of sequential spaces may not preserve the separability conditions of the original topological space. This is particularly interesting for the T_1 condition, which is translated to limit operators by the idempotent property (so points are closed with the associated sequential topology). As we will see on Example 1.45, we can obtain a non idempotent limit operator L_Q even when L is.

1.1.1 Spacetime covering projections: The causal ladder and main properties

Let us consider an action on V given by a group G of isometric maps

$$\begin{aligned} G \times V &\rightarrow V \\ (g, p) &\rightarrow gp. \end{aligned}$$

We will always assume that the action preserves time-orientation, and acts freely and *properly discontinuously*, where the latter means: (a) for each $p \in V$, there exists a neighborhood U such that $gU \cap U = \emptyset$ for all $g \in G \setminus \{e\}$ and; (b) for $p_1, p_2 \in V$ there are neighbourhoods U_1 and U_2 such that $gU_1 \cap U_2 = \emptyset$ for all $g \in G$.

The previous conditions over the action ensure that the quotient space $M = V/G$ is also a Lorentzian manifold with the induced metric (which will be denoted by an abuse of notation as g). The canonical projection to the quotient space, denoted by $\pi : V \rightarrow M$, will be called a *spacetime covering projection*. The following result allows us to clearly understand the relation between the chronological relation on M and V (the same result follows for causal relations, see [56, Prop. 1.1]).

Proposition 1.5. *Let us consider $\pi : V \rightarrow M$ a spacetime covering projection. Then:*

- *If $p, q \in V$ satisfy that $p \ll q$, then $\pi(p) \ll \pi(q)$.*
- *If $x, y \in M$ satisfy that $x \ll y$, then for any $p, q \in V$ with $\pi(p) = x$ and $\pi(q) = y$, there exists an element $g \in G$ such that $p \ll gq$.*

As it is clear, the previous result is key to understand the relation between the causal structures of both, V and M . From a global viewpoint, it is possible to characterize all the stages of the well known causal ladder on M (see [77]) in terms of the global causal structure of V . We will summarize in the following result some of such characterizations, whose proofs can be found on [56, Props. 1.2, 1.3 and 1.4] (with some minor improvements).

Theorem 1.6. *Let $\pi : V \rightarrow M$ be a spacetime covering projection with group G . Then:*

(CL1) *M is non-totally vicious if, and only if, there exists $p \in V$ such that $I^+(p) \cap \pi^{-1}(\pi(p)) = \emptyset$.*

(CL2) *M is chronological if, and only if, for all $p, q \in V$ with $\pi(p) = \pi(q)$, $p \not\ll q$.*

(CL3) *M is causal if, and only if, for all $p, q \in V$ with $\pi(p) = \pi(q)$, $p \not\prec q$.*

(CL4) M is strongly causal if, and only if, for all $p \in V$ there is a fundamental neighbourhood system $\{U_n\}$ for p such that for each n , no causal curve can have one endpoint in U_n and another endpoint in a component U'_n of $\pi^{-1}(\pi(U_n))$ unless $U'_n = U_n$ and the curve remains wholly within U_n .

(CL5) M is globally hyperbolic if, and only if,

(CL5-1) V is globally hyperbolic,

(CL5-2) for all $p, q \in V$ with $\pi(p) = \pi(q)$, $p \not\ll q$.²

(CL5-3) for any $p \in V$, for all $p \ll q$, $J^+(p) \cap \pi^{-1}(\pi(q))$ is finite.

Let us remark that in all previous cases, a global causal condition on M (i.e., the assumption of a stage in the causal ladder) implies a stronger global condition on V . However at this point, it is not clear for us at what extent the same property holds for the remaining levels of the causal ladder (particularly with *causally continuous* and *causally simple*), being necessary a detailed study on such cases.

1.2 Partial boundaries under the action of the group

In this section, we will study the behaviour of the future causal completion under the action of an isometry group G , being the past case completely analogous. Let us begin with a point in the future completion of V , that is, an indecomposable set $\bar{P} = I^-(\{p_n\}_n)$ ³, where $\{p_n\}_n$ is a future-directed chronological sequence. As the group G acts by isometries in V , the sequence $\{x_n\}_n$ with $\pi(p_n) = x_n$ is also future-directed and chronological (Prop. 1.5), hence, it defines the indecomposable set $P = I^-(\{x_n\}_n)$ in M (see [48, Thm. 2.1]). Therefore, the projection π extends naturally to the corresponding partial completions on the following way:

$$\begin{aligned} \hat{\pi} : \quad \hat{V} &\rightarrow \hat{M} \\ \bar{P} = I^-(\{p_n\}_n) &\rightarrow P = I^-(\{x_n\}_n). \end{aligned} \tag{1.3}$$

We will say that an indecomposable set $\bar{P} \in \hat{V}$ is a *lift* of P if $\hat{\pi}(\bar{P}) = P$.

The map $\hat{\pi}$ is always surjective, as any future-directed chronological sequence $\{x_n\}_n$ in M can be lifted to a future-directed chronological sequence $\{p_n\}_n$ in V (by Prop. 1.5). However, the map is not injective in general, as the previous lift is not unique. For instance, if $\{p_n\}_n$ is a lift of $\{x_n\}_n$, then, $\{g p_n\}_n$ (for any $g \in G$) is also a lift of the same sequence. Even more, the pre-image of a terminal set P can be easily characterized. Let us denote by $\bar{P} = I^-(\{p_n\}_n)$, where $\{p_n\}_n$ denotes one fixed lift of $\{x_n\}_n$. It follows that

$$\hat{\pi}^{-1}(P) = \cup_{g \in G} g \bar{P},$$

i.e., the pre-image of P is the union of what we are going to call the G -orbit of \bar{P} in \hat{V} , which is the set $\{g \bar{P}\}_{g \in G}$. Notice that $\cup_{g \in G} g \bar{P} \subset \hat{\pi}^{-1}(P)$ is straightforward, as $\hat{\pi}(g \bar{P}) = P$ for all $g \in G$. On the other hand, take a point $x \in P$ and let $p \in V$ be a point such that $\pi(p) = x$. As $x \in P$, there exists n big enough such that $x \ll x_n$. Hence, Prop. 1.5 ensures that $p \ll g p_n \in g \bar{P}$ for some $g \in G$.

²Globally hyperbolic spacetimes can be defined as causal spacetimes with compact $J^+(x) \cap J^-(y)$ for all $x, y \in M$, see [16, Thm. 3.2]. So, condition (CL5-2) ensures that (M, g) is a causal spacetime. The proof for the compactness of $J^+(x) \cap J^-(y)$ for all $x, y \in M$ follows as in [56, Prop. 1.4].

³In order to distinguish IPs (IFs) of V and IPs (IFs) in M , we will denote by \bar{P} the IPs (resp. \bar{F} the IFs) in V and denote by P the IPs (resp. F the IFs) in M .

Convention 1.7. From this point on, there are some useful conventions that we will use in the remainder of this chapter. For instance, the points on M will be denoted by x, y, z , while the points on V will be denoted by p, q, r . Moreover, unless stated otherwise, we will always assume that $\pi(p) = x, \pi(q) = y$ and $\pi(r) = z$.

For any chronological sequence $\{x_n\}_n$ in M (resp., an indecomposable set P), we will consider a fixed lift on V denoted by $\{p_n\}_n$ (resp. \bar{P}). As an abuse of notation, we will use the same symbol I^\pm for future/past of sets in M or V when there is no confusion.

Finally, and in order to compute both, the partial and c-boundary, we will assume from this point on that M is strongly causal and so that V satisfies the condition described on Thm. 1.6 (CL4).

The projection $\hat{\pi}$ let us define an equivalence relation on \hat{V} : two indecomposable past sets $\bar{P}_1, \bar{P}_2 \in \hat{V}$ are \hat{G} -related, $\bar{P}_1 \sim_{\hat{G}} \bar{P}_2$, if and only if both indecomposable past sets project onto the same $P \in \hat{M}$, i.e., $\hat{\pi}(\bar{P}_1) = \hat{\pi}(\bar{P}_2)$. Of course, the previous relation leads us to a bijection between the quotient space $\hat{V}/\hat{G} (\equiv \hat{V}/\sim_{\hat{G}})$ and \hat{M} . However, the following two observations are in order: On the one hand, one could expect naively that for any two terminal sets with $\bar{P}_1 \sim_{\hat{G}} \bar{P}_2$, there exists $g \in G$ such that $\bar{P}_1 = g\bar{P}_2$. However, the following simple example shows that such a property is not true in general: consider the two-dimensional Lorentz Minkowski spacetime, \mathbb{L}^2 , with the action

$$\begin{aligned} \mathbb{Z} \times \mathbb{L}^2 &\rightarrow \mathbb{L}^2 \\ (z, (x, t)) &\rightarrow (x + z, t) \end{aligned}$$

defined on it. The lightlike line $\gamma(t) = (t, t)$ defines naturally a terminal set $\bar{P} \neq V$. The \mathbb{Z} -orbit of \bar{P} is the complete spacetime \mathbb{L}^2 , so both \mathbb{L}^2 and \bar{P} will be $\hat{\mathbb{Z}}$ -related, but no element of the group maps one to the other.

In any case, there are several examples where previous property is naturally satisfied. For instance, the same previous group action will satisfy the property if it is restricted to $V = \mathbb{R} \times (a, b) \subset \mathbb{L}^2$. In fact, we can construct even more physically appealing examples for Robertson Walker spacetimes satisfying the integral conditions (1.13) (recall that, in terms of causality, Robertson Walker models satisfying such integral conditions behave like Lorentzian product spaces with a finite time interval, see [5]). This motivates the following definition:

Definition 1.8. *A spacetime covering projection $\pi : V \rightarrow M$ is future tame if given two indecomposable past sets \bar{P}_1, \bar{P}_2 with $\bar{P}_1 \sim_{\hat{G}} \bar{P}_2$ there exists $g \in G$ such that $\bar{P}_1 = g\bar{P}_2$.*

On the other hand, the induced map $\hat{\pi}$ is not well behaved at the topological level. In fact, Harris shows in the last example of [56] that $\hat{\pi}$ is not, in general, continuous (see also Example 1.45 for details).

The rest of this section is devoted to make a deep comparison between the topologies of \hat{M} and \hat{V}/\hat{G} , where the latter space has the induced quotient topology. Let us first fix some notation. As we have mentioned before in the preliminaries of this work, the future causal completions \hat{M} and \hat{V} will be endowed with the future chronological topology, which is defined by a limit operator (3). In order to differentiate both limits, we will denote by \hat{L}_M the future chronological limit on \hat{M} and, accordingly, \hat{L}_V the limit on \hat{V} . The quotient topology on \hat{V}/\hat{G} is also a sequential topology (see Section 1.1) and it is defined from a limit operator (1.2) which will be denoted here by $\hat{L}_{\hat{G}}$. Finally, recall that the map $\hat{\pi}$ induces a bijective map \hat{j} between \hat{V}/\hat{G} and \hat{M} which makes the following diagram commutative:

$$\begin{array}{ccc}
\hat{V} & & \\
\hat{i} \downarrow & \searrow \hat{\pi} & \\
\hat{V}/\hat{G} & \xrightarrow{\hat{j}} & \hat{M}
\end{array}$$

being $\hat{i}: \hat{V} \rightarrow \hat{V}/\hat{G}$ the usual projection.

The previous \hat{j} map is always open. In order to prove this, we require the following technical lemma.

Lemma 1.9. *Consider a sequence $\sigma = \{P_n\}_n \subset \hat{M}$ and a point $P \in \hat{M}$ such that $P \in \text{LI}(\{P_n\}_n)$. For \bar{P} a fixed lift of P , there exist lifts \bar{P}_n of P_n such that $\bar{P} \in \text{LI}(\{\bar{P}_n\}_n)$.*

Proof. Let us begin by taking $\{\bar{P}_n\}_n$ some fixed lifts of $\{P_n\}_n$. Denote also by $\{p_n\}_n$ and $\{x_n\}_n$ future chronological chains defining \bar{P} and P resp. and satisfying that $\pi(p_n) = x_n$ (as stated in Convention 1.7). As $P \in \text{LI}(\{P_n\}_n)$, for any element x_n there exists $m_n \in \mathbb{N}$ (that we can consider strictly increasing on n) such that, for all $m \geq m_n$, $x_n \in P_m$. So, there exists $g \in G$ such that $p_n \in g\bar{P}_m$. In fact, let $y \in P_m$ such that $x_n \ll y$ and $q \in \bar{P}_m$ a lift of y . From Prop. 1.5 there exists some $g \in G$ such that $p_n \ll gq$, where $gq \in g\bar{P}_m$. Then, for $m \geq m_n$, let us denote by $G(n, m) \subset G$ the non-empty subset defined in the following way:

$$G(n, m) := \{g \in G : p_n \in g\bar{P}_m\} \quad (1.4)$$

Let us make a straightforward (but necessary) observation about the previous sets. As $p_n \ll p_{n+1}$, for $m \geq m_{n+1} \geq m_n + 1$,

$$G(n+1, m) \subset G(n, m). \quad (1.5)$$

Now, for each $m_n \leq m < m_{n+1}$, let us consider a group element $g_m \in G(n, m)$ and consider the sequence $\{g_m \bar{P}_m\}_m$ (for $m < m_1$, just consider $g_m = e$, the identity). Now, let us show that the previous sequence works, that is, $\bar{P} \in \text{LI}(\{g_m \bar{P}_m\}_m)$. In fact, for any $n \in \mathbb{N}$, consider $m \geq m_n$ and denote by $k \in \mathbb{N} \cup \{0\}$ the natural number ensuring that $m_{n+k+1} > m \geq m_{n+k}$. Then, from the choice of $\{g_m\}_m$ and (1.5), we have that:

$$g_m \in G(n+k, m) \subset G(n+k-1, m) \subset \dots \subset G(n, m).$$

In conclusion, from (1.4) we deduce that $p_n \in g_m \bar{P}_m$ for all $m \geq m_n$, and the result follows. \square

Proposition 1.10. *Let $\pi: V \rightarrow M$ be a spacetime covering projection and $\hat{\pi}: \hat{V} \rightarrow \hat{M}$ the extended map on the corresponding partial completions. The induced map $\hat{j}: \hat{V}/\hat{G} \rightarrow \hat{M}$ is open.*

Proof. Let us prove that the map \hat{j}^{-1} is continuous by using Prop. 1.3. For this, consider a sequence $\sigma = \{P_n\}_n \subset \hat{M}$ and a point $P \in \hat{L}_M(\sigma)$, and let us show that $\hat{j}^{-1}(P) \in \hat{L}_{\hat{G}}(\hat{j}^{-1}(\sigma))$ for some subsequence $\kappa \subset \sigma$. Recall that, from the definitions of $\hat{L}_{\hat{G}}$ and \hat{j}^{-1} , this is equivalent to showing the existence of lifts \bar{P}_n and \bar{P} of P_n and P resp. such that $\bar{P} \in \hat{L}_V(\{\bar{P}_{n_k}\}_k)$ for some subsequence $\{\bar{P}_{n_k}\}_k \subset \{\bar{P}_n\}_n$.

First observe that, by using the previous lemma, we can find lifts \bar{P}_n and \bar{P} of P_n and P resp. such that $\bar{P} \in \text{LI}(\{\bar{P}_n\}_n)$. If \bar{P} is maximal in $\text{LS}(\{\bar{P}_n\}_n)$, then we have that $\bar{P} \in \hat{L}_V(\{\bar{P}_n\}_n)$, and we are done.

Otherwise, take \bar{P}' a maximal set in $\text{LS}(\{\bar{P}_n\}_n)$ containing \bar{P} , and let $\{p'_n\}_n$ be a future chronological sequence generating \bar{P}' . As $\bar{P}' \in \text{LS}(\{\bar{P}_n\}_n)$, it is possible to find a strictly increasing subsequence $\{k_n\}_n$ such that $p'_n \in \bar{P}_{k_n}$ for all n . Then, it follows readily that $\bar{P}' \in \hat{L}_V(\{\bar{P}_{k_n}\}_k)$. Now

observe that the sets $P' = \hat{\pi}(\overline{P}')$ and $P_{n_k} = \hat{\pi}(\overline{P}_{n_k})$ satisfy the following chain since $\hat{\pi}$ preserves contentions:

$$P \subset P' \subset \text{LI}(\{P_{n_k}\}_k).$$

But as $P \in \hat{L}_M(\{P_{n_k}\}_k)$, it follows that $P = P'$ (recall the maximal character on (3)) and so that \overline{P}' is also a lift of P .

In both cases, and up to a subsequence, we show the existence of lifts $\{\overline{P}_n\}_n$ and \overline{P} with $\overline{P} \in \hat{L}_V(\{\overline{P}_n\}_n)$, and then the continuity of \hat{j}^{-1} follows from Prop. 1.3. \square

Remark 1.11. The previous proof shows in particular that for all $P \in \hat{L}_M(\{P_n\}_n)$, there exist lifts \overline{P} and \overline{P}_n of P and P_n resp. with $\overline{P} \in \hat{L}_V(\{\overline{P}_{n_k}\}_k)$ for some subsequence $\{\overline{P}_{n_k}\}_k$ of $\{\overline{P}_n\}_n$.

As we have already pointed out, the map \hat{j} is not continuous in general. If we look into the details of Example 1.45 (see Example 1.47 for an alternative illustration of this situation), we see that the non-continuity of \hat{j} is related with the following situation: There exists a (non-necessarily chronological) sequence $\{P_n\}_n \subset \hat{M}$ admitting two different lifts such that (i) both lifted sequences are convergent and (ii) the projection of one limit point strictly contains the other. As we will see, the existence of this kind of sequences in M represents, essentially, the only case where continuity of $\hat{\pi}$ can fail, so, it is convenient to give a proper name for it:

Definition 1.12. Let $\pi : V \rightarrow M$ a spacetime covering projection and \hat{V}, \hat{M} the corresponding future causal completions of V and M . We will say that a sequence $\sigma = \{P_n\}_n \subset \hat{M}$ has future divergent lifts if there exist two lifts $\{\overline{P}_n\}_n, \{\overline{P}'_n\}_n \subset \hat{V}$ of σ and two points $\overline{P}, \overline{P}' \in \hat{V}$ such that:

- (i) $\overline{P} \in \hat{L}_V(\{\overline{P}_n\}_n)$ and $\overline{P}' \in \hat{L}_V(\{\overline{P}'_n\}_n)$.
- (ii) $\hat{\pi}(\overline{P}) \subsetneq \hat{\pi}(\overline{P}')$.

If there exists no such a sequence on \hat{M} , we will just say that M does not admit sequences with future divergent lifts.

As a side remark, observe that the concept of divergent lifts is closely related with the topological structure of the G -orbits in \hat{V} . In fact, we can prove the following result:

Proposition 1.13. Let π be future tame. Then, the G -orbits of \hat{V} are closed if and only if M does not admit constant sequences with divergent lifts.

Proof. For the right implication let $P \in \hat{M}$ and $\overline{P} \in \hat{V}$ with $\hat{\pi}(\overline{P}) = P$. Observe that by the tame condition every lift of the constant sequence $\{P\}_n$ has the form $\{g_n \overline{P}\}_n$ where $g_n \in G$. So, if $\overline{P}' \in \hat{V}$ is such that $\overline{P}' \in \hat{L}_V(\{g_n \overline{P}\}_n)$ then the closedness of the G -orbit ensures that $\overline{P}' = g_0 \overline{P}$ for some $g_0 \in G$. Therefore, $\{P\}_n$ admits no divergent lifts as condition (ii) in Defn. 1.12 cannot be fulfilled.

For the left one, assume that M admits no constant sequence with divergent lifts and let us prove that the G -orbits in \hat{V} are closed. Let $P, \overline{P}, \overline{P}'$ and $\{g_n\}_n$ as in the previous implication. As M admits no constant sequence with divergent lifts, then necessarily it follows that $\hat{\pi}(\overline{P}') = P$. Moreover, as π is future tame, then there exists $g_0 \in G$ such that $\overline{P}' = g_0 \overline{P}$, and so, \overline{P}' belongs to the G -orbit $\{g \overline{P}\}_{g \in G}$ and the G -orbit is closed. \square

The optimality of the previous result follows from Example 1.49 where we present a case where M admits no constant sequence with divergent lifts but the G -orbits are not closed.

Our main technical result on this section is the following characterization of the continuity of $\hat{\pi}$ (up to the first order UTS condition):

Proposition 1.14. *Let $\{\bar{P}_n\}_n$ be a sequence whose projection $\{P_n\}_n$ does not admit divergent lifts. Then,*

$$\bar{P} \in \hat{L}_V(\{\bar{P}_n\}_n) \Rightarrow P := \hat{\pi}(\bar{P}) \in \hat{L}_M(\{P_n\}_n).$$

In particular, if M does not admit sequences with future divergent lifts, the map $\hat{\pi}$ is continuous. Conversely, if the map $\hat{\pi}$ is continuous and additionally the future chronological limit \hat{L}_M on \hat{M} is of first order UTS, then there are no sequences with divergent lifts.

Proof. Let $\bar{\sigma} = \{\bar{P}_n\}_n$ be a sequence as in the first statement of the proposition, and consider $\bar{P} \in \hat{L}_V(\bar{\sigma})$. By recalling that $\hat{\pi}$ preserves contentions, we deduce that $P \in \text{LI}(\{P_n\}_n)$. If P is maximal among the IPs in $\text{LS}(\{P_n\}_n)$, then $P \in \hat{L}_M(\{P_n\}_n)$ and we are done.

So, let us assume by contradiction that P is not maximal on the $\text{LS}(\{P_n\}_n)$. Consider P' a maximal IP on $\text{LS}(\{P_n\}_n)$ containing strictly P . From the definition of the superior limit, and up to a subsequence, we can assume that $P' \in \text{LI}(\{P_n\}_n)$, and so, that $P' \in \hat{L}_M(\{P_n\}_n)$. Now, recalling Rem. 1.11, we ensure that P_n and P' admit lifts \bar{P}'_n and \bar{P}' such that $\bar{P}' \in \hat{L}_V(\{\bar{P}'_{n_k}\}_k)$. Summarizing, the sequence $\{P_{n_k}\}_k$ admits two lifts $\{\bar{P}_{n_k}\}_k$ and $\{\bar{P}'_{n_k}\}_k$ converging to \bar{P} and \bar{P}' resp., where $P = \hat{\pi}(\bar{P}) \subsetneq \hat{\pi}(\bar{P}') = P'$. That is to say, $\{P_{n_k}\}_k$ admits future divergent lifts, a contradiction. In conclusion, $P \in \hat{L}_M(\{P_n\}_n)$. Moreover, if M does not admit sequences with divergent lifts, $\hat{\pi}$ is continuous (recall Prop. 1.3).

For the final assertion, assume that \hat{L}_M is of first order UTS and that there exists a sequence $\sigma = \{P_n\}_n \subset \hat{M}$ with divergent lifts. Let $\{\bar{P}_n\}_n, \{\bar{P}'_n\}_n$ be two sequences in \hat{V} and \bar{P}, \bar{P}' two terminal sets as in Defn. 1.12. Assume by contradiction that $\hat{\pi}$ is continuous. In particular, we have that $\{P_n\}_n$ (the projection by $\hat{\pi}$ of both sequences $\{\bar{P}_n\}_n$ and $\{\bar{P}'_n\}_n$) converges to P and P' . As \hat{L}_M is of first order UTS, we can assume that (up to a subsequence) \hat{L}_M is of first order for $\{P_n\}_n$, and so, that $P, P' \in \hat{L}_M(\{P_n\}_n)$. But this is a contradiction with the definition of \hat{L}_M (3) (concretely the maximal character of the limit points) and the fact that $P \subsetneq P'$ (Defn. 1.12 (ii)). Therefore, the map $\hat{\pi}$ cannot be continuous. \square

There are several ways to prove the non-existence of sequences with divergent lifts. For instance, we can impose conditions on the causality of the boundary (recovering [56, Thm. 3.4])

Corollary 1.15. *If \hat{M} has only spatial future boundary points (see Defn. 13 and Footnote 3), then $\hat{\pi}$ is continuous, and so, \hat{j} is a homeomorphism between \hat{M} and \hat{V} / \hat{G} .*

Proof. Assume by contradiction that $\hat{\pi}$ is not continuous and so, from the previous result, that there exists a sequence $\sigma \subset \hat{M}$ admitting divergent lifts. Let $\bar{\sigma}, \bar{\sigma}'$ be two sequences in \hat{V} and \bar{P}, \bar{P}' be two points in \hat{V} as in Defn. 1.12. As \hat{M} only contains spatial future boundary points, no IP can contain a TIP. Hence, from (ii) in Defn. 1.12, we deduce that $P = I^-(x)$ for some $x \in M$, and then, $\bar{P} = I^-(p)$ for some point $p \in V$. As $\pi : V \rightarrow M$ is continuous and the future chronological topology preserves the manifold topology (which follows from Thm. 17, (i)), we have that $P \in \hat{L}_M(\{P_n\}_n)$. Finally from (i) and (ii) in Defn. 1.12 we have that $P \subsetneq P' \in \text{LI}(\{P_n\}_n)$, in contradiction with the maximality on (3). \square

Another possibility is to impose conditions over the topology of the future causal completion. In this case, we also need to impose the finiteness of the group G :

Corollary 1.16. *Consider $\pi : V \rightarrow M$ a spacetime covering projection with associated group G . Assume that G is finite and that \hat{V} is Hausdorff. Then, $\hat{\pi}$ is continuous, and so, \hat{j} is a homeomorphism.*

Proof. As we will see in the forthcoming sections, if G is finite then π is future tame (see Lemma 1.35). Hence, let us consider two sequences $\{\bar{P}_n\}_n, \{\bar{P}'_n\}_n \subset \hat{V}$ and two points $\bar{P}, \bar{P}' \in \hat{V}$ with $\bar{P} \in \hat{L}_V(\{\bar{P}_n\}_n)$ and $\bar{P}' \in \hat{L}_V(\{\bar{P}'_n\}_n)$ and such that $\hat{\pi}(\bar{P}_n) = \hat{\pi}(\bar{P}'_n)$. Our aim is to prove that $\hat{\pi}(\bar{P}) = \hat{\pi}(\bar{P}')$ as then no sequence with divergent lifts can exist.

Recalling the tameness of π , there exists a sequence $\{g_n\}_n \subset G$ such that $\bar{P}'_n = g_n \bar{P}_n$. Due to the assumption that G is finite, we can assume (up to a subsequence) that $g_n \equiv g_0$ for all n and some constant $g_0 \in G$. Therefore, $\bar{P} \in \hat{L}_V(\{\bar{P}_n\}_n)$ and $\bar{P}' \in \hat{L}_V(\{g_0 \bar{P}_n\}_n)$. From the first inclusion and the fact that G acts by isometries, we deduce that $g_0 \bar{P}$ also belongs to $\hat{L}_V(\{g_0 \bar{P}_n\}_n)$. Moreover, \hat{V} is Hausdorff and so, for any sequence σ , $\hat{L}_V(\sigma)$ can contain at most one element (recall (1.1)), it follows that $g_0 \bar{P} = \bar{P}'$, as desired. \square

Summarizing, we just establish the main theorem in this section:

Theorem 1.17. *Let $\pi : V \rightarrow M$ be a spacetime covering projection (see Section 1.1.1) and denote by $\hat{\pi}$ the extension to future c -completions (1.3). Let \hat{V}/\hat{G} be the quotient space defined by the following relation: two points $\bar{P}, \bar{P}' \in \hat{V}$ are $\sim_{\hat{G}}$ -related if they project onto the same point in \hat{M} . Then, we obtain the following commutative diagram:*

$$\begin{array}{ccc} \hat{V} & & \\ \hat{\imath} \downarrow & \searrow \hat{\pi} & \\ \hat{V}/\hat{G} & \xrightarrow{\hat{\jmath}} & \hat{M} \end{array}$$

where $\hat{\imath}$ is the natural quotient projection. From construction, the map $\hat{\jmath}$ is bijective. At the topological level,

- (i) The map $\hat{\jmath}$ is open.
- (ii) If M does not admit sequences with future divergent lifts (Defn. 1.12), the map $\hat{\pi}$ (and so, $\hat{\jmath}$) is continuous. The converse also follows if we have that \hat{L}_M is of first order UTS (Defn. 1.1).

In particular, if M has only spatial future boundary points, $\hat{\jmath}$ is a homeomorphism between \hat{V}/\hat{G} and \hat{M} . The same result follows if G is finite and \hat{V} is Hausdorff.

Proof. Assertion (i) follows from Prop. 1.10, while (ii) from Prop. 1.14. The last assertion is proved in Corollaries 1.15 and 1.16. \square

1.3 The c -completion under the action of the group

Once we have determined the requirements to ensure the good behaviour of the partial boundaries, we are in conditions to study the (total) c -completion. As a first step, we will deal with the projection and lift of points of the corresponding c -completions \bar{V} and \bar{M} , in order to define an extension $\bar{\pi} : \bar{V} \rightarrow \bar{M}$. Later, we will study the properties of such a map at both, the chronological and the topological level.

1.3.1 Point set level

Let us begin by considering $\bar{P} \in \hat{V}$ and $\bar{F} \in \check{V}$ two non empty indecomposable sets which are S -related, so $(\bar{P}, \bar{F}) \in \bar{V}$; and let us study when the projections of each component of the pair of such terminal sets are S -related. Of course, if these sets correspond to the past and future of a point $p \in V$, their projections will correspond to the past and future of the projection $x = \pi(p) \in M$ (and so, they are S -related). Therefore, we can assume that \bar{P} and \bar{F} are terminal sets. Let us denote by $\{p_n\}_n$ and $\{q_n\}_n$ the corresponding inextensible (future and past resp.) chronological sequences defining them. From the definitions of the S -relation and the chronological limits, it follows that $\bar{P} \in \hat{L}_V(\{I^-(q_n)\}_n)$ (see Thm. 17 (ii)). If the past chronological sequence $\{y_n\}_n$ (projection of $\{q_n\}_n$) does not admit future divergent lifts, then Prop. 1.14 ensures that $P := \hat{\pi}(\bar{P}) \in \hat{L}_M(\{I^-(y_n)\}_n)$. Then, taking into account that the past chronological sequence $\{y_n\}_n$ determines $F := \check{\pi}(\bar{F})$, we obtain that $P \subset\downarrow F$ and it is maximal inside such a subset (see (3)). Analogously, assuming that the future chronological chain $\{x_n\}_n$ does not admit past divergent lifts, we can prove that $F \subset\uparrow P$ and it is maximal, so we have establish:

Proposition 1.18. *Let $\pi : V \rightarrow M$ be a spacetime covering projection. Assume that M does not admit an inextensible sequence $\{x_n\}_n \subset M$ which is either past-directed chronological with future divergent lifts or future-directed chronological with past divergent lifts. If $(\bar{P}, \bar{F}) \in \bar{V}$ with $\bar{P} \neq \emptyset \neq \bar{F}$, then $(P, F) \in \bar{M}$, where $P = \hat{\pi}(\bar{P})$ and $F = \check{\pi}(\bar{F})$.*

The condition on the future and past sequences in M , which appears in Prop. 1.18, is fulfilled in strongly regular cases as globally hyperbolic models, where, inextensible past-directed (resp. future-directed) chronological sequences have no future (resp. past) limit. However, there are other (not so regular) cases, as the one showed in Cor. 1.40 (which includes some Robertson-Walker models with an appropriate group action, see Section 1.5) or the one in Example 1.48, where the condition is naturally fulfilled.

At the point set level, Prop. 1.18 deals with the general case where points are well projected. In fact, Examples 1.46 and 1.47 show cases of points in \bar{V} with no natural projection in \bar{M} . Moreover, these examples also show that the lifts of points from \bar{M} are not, in general, well behaved either. Concretely, as we can see in Example 1.47, the point (P_2, \emptyset) has no natural lift in \bar{V} . The only possible candidate is the point (\bar{P}_2, \bar{F}) , but $(P_2, \emptyset) \neq (\hat{\pi}(\bar{P}_2), \check{\pi}(\bar{F}))$, even more this last point does not belong to \bar{M} .

However, if we characterize the conditions under which the lift of points $(P, F) \in \bar{M}$ with both components non empty are well defined, then we will be in conditions to define the projection between \bar{V} and \bar{M} .

Proposition 1.19. *Consider a point $(P, F) \in \bar{M}$ with $P \neq \emptyset \neq F$. The point (P, F) has a lift in \bar{V} , i.e., a pair $(\bar{P}, \bar{F}) \in \bar{V}$ with $P = \hat{\pi}(\bar{P})$ and $F = \check{\pi}(\bar{F})$ if and only if there exist lifts \bar{P}' and \bar{F}' of P and F resp. such that $\bar{P}' \subset\downarrow \bar{F}'$ (or, equivalently, $\bar{F}' \subset\uparrow \bar{P}'$).*

Proof. One implication is trivial, so, we only need to focus on the other, that is, consider a point $(P, F) \in \bar{M}$ and suppose that there exist lifts \bar{P}' and \bar{F}' such that $\bar{P}' \subset\downarrow \bar{F}'$ (and so, with $\bar{F}' \subset\uparrow \bar{P}'$). We can ensure then the existence of an IP \bar{P} with $\bar{P}' \subset \bar{P}$ and maximal among the indecomposable sets contained in $\downarrow \bar{F}'$. Recalling that the projection preserves the contentions, we deduce that $P \subset \hat{\pi}(\bar{P}) \subset\downarrow F$. However $P \sim_S F$, so the maximality on (5) implies that $P = \hat{\pi}(\bar{P})$.

Reasoning in the same way with $\bar{F}' \subset\uparrow \bar{P}$, we can prove that there exists \bar{F} with $\check{\pi}(\bar{F}) = F$ and being a maximal IP contained in $\uparrow \bar{P}$. In conclusion, $\bar{P} \sim_S \bar{F}$ and the pair (\bar{P}, \bar{F}) belongs to \bar{V} . Moreover, from construction $\hat{\pi}(\bar{P}) = P$ and $\check{\pi}(\bar{F}) = F$, as desired. \square

Remark 1.20. Recall that the previous proof does not imply that the initial \bar{P}' and \bar{F}' are S -related, but that there exist other indecomposable S -related sets \bar{P} and \bar{F} such that: (a) $\bar{P}' \subset \bar{P}$, $\bar{F}' \subset \bar{F}$ and (b) $\hat{\pi}(\bar{P}) = \hat{\pi}(\bar{P}')$ and $\check{\pi}(\bar{F}) = \check{\pi}(\bar{F}')$

Now, we are ready to extend the projection to the c -completions. However, the definition of the projection is far more technical than the partial cases. The main problem here is the existence of different candidates for the projection of pairs (\bar{P}, \emptyset) and (\emptyset, \bar{F}) , and no reason to prioritize one of the candidates over the other. This will be reflected on the existence of different extensions of π (depending on the choice we made for the projection) for the general case. Nonetheless, as we will see along this section, all the possible definitions will share the same properties. Moreover, all the ambiguity in the choice of an extension will disappear under some additional properties such as tameness or finite chronology (see Section 1.3.4).

Let $(\bar{P}, \emptyset) \in \partial V$ be a point in the c -boundary and let us analyse the possible projections that such a point can have on ∂M (an analogous study can be made for (\emptyset, \bar{F})). The first natural candidate to consider (taking the corresponding projection of each component) is the pair (P, \emptyset) with $P = \hat{\pi}(\bar{P})$. However, as shown by Example 1.49, it is not necessarily true that $P \sim_S \emptyset$. In fact, another pair (\bar{P}', \bar{F}') with $\bar{P}' \neq \emptyset \neq \bar{F}'$ and with $\hat{\pi}(\bar{P}) = \hat{\pi}(\bar{P}')$ could exist. If the projection of the components is well behaved under the S -relation (for example, as in Prop. 1.18), then $P = \hat{\pi}(\bar{P}') \sim_S \check{\pi}(\bar{F}')$. Therefore, it seems more natural to define the projection of (\bar{P}, \emptyset) as the projection (by components) of (\bar{P}', \bar{F}') .

Nonetheless, the previous process does not give an unique way to define such a projection. This is shown in Example 1.50, where we have three points $(\bar{P}, \emptyset), (\bar{P}', \bar{F}'), (\bar{P}'', \bar{F}'') \in \partial V$ with $P = \hat{\pi}(\bar{P}) = \hat{\pi}(\bar{P}') = \hat{\pi}(\bar{P}'')$ but also satisfying that $\check{\pi}(\bar{F}') \neq \check{\pi}(\bar{F}'')$. Both points $(\bar{P}', \bar{F}'), (\bar{P}'', \bar{F}'')$ share the same properties, and thus there are no arguments to prioritize one over the other. So, a choice has to be made and different projections between \bar{V} and \bar{M} appear.

In order to formalize our discussion on the definition of the extended projection, let us define a relation \sim_{G_0} between pairs satisfying that $(\bar{P}, \emptyset) \sim_{G_0} (\bar{P}', \bar{F}')$ (resp. $(\emptyset, \bar{F}) \sim_{G_0} (\bar{P}', \bar{F}')$) if $\hat{\pi}(\bar{P}) = \hat{\pi}(\bar{P}')$ (resp. $\check{\pi}(\bar{F}) = \check{\pi}(\bar{F}')$). Then, define a map $\alpha : \bar{V} \rightarrow \bar{V}$ as

$$\alpha((\bar{P}, \bar{F})) = \begin{cases} \text{Some pair } (\bar{P}', \bar{F}') \in \bar{V} \text{ with } (\bar{P}, \bar{F}) \sim_{G_0} (\bar{P}', \bar{F}') & \text{if } \bar{P} = \emptyset \text{ or } \bar{F} = \emptyset \\ \text{(and } \bar{P}' \neq \emptyset \neq \bar{F}') & \\ (\bar{P}, \bar{F}) & \text{otherwise.} \end{cases} \quad (1.6)$$

The existence of such a map is always ensured, but it is not in general unique as it depends on the selected element (\bar{P}', \bar{F}') . Once a map α is chosen, we are in conditions to define the extended projection.

Definition 1.21. Consider $\pi : V \rightarrow M$ a spacetime covering projection induced by an action of a group G and let α be a choice as defined on previous paragraph. Then we define $\bar{\pi}_\alpha : \bar{V} \rightarrow \hat{M}_\emptyset \times \check{M}_\emptyset$ given by $\bar{\pi}_\alpha = \bar{\pi} \circ \alpha$, where

$$\bar{\pi} : \bar{V} \rightarrow \hat{M}_\emptyset \times \check{M}_\emptyset, \quad \bar{\pi}((\bar{P}, \bar{F})) = (\hat{\pi}(\bar{P}), \check{\pi}(\bar{F})) \quad (1.7)$$

and we are defining $\hat{\pi}(\emptyset) = \emptyset$ and $\check{\pi}(\emptyset) = \emptyset$.

Remark 1.22. (a) Let us emphasize that the definition of α is nothing but a technical requirement in order to define an extension of the projection, and its concrete definition and properties will not affect the results from this point on (see for instance the discussion in Example 1.50). Therefore, and in order to simplify the notation, we will drop the subindex α on the definition of $\bar{\pi}_\alpha$, always assuming that a map α has been fixed from the beginning.

(b) It is also worth mentioning at this point that, in our main results, we have to include additional hypothesis as tameness or finite chronology (see Defn. 1.31), which will imply that there are no pairs (\bar{P}, \emptyset) and (\bar{P}', \bar{F}') in \bar{V} with $\bar{P}' \neq \emptyset \neq \bar{F}'$ and $(\bar{P}, \emptyset) \sim_{G_0} (\bar{P}', \bar{F}')$ (with analogous

version for the future, see Lemma 1.24 and Prop. 1.38). In these cases, α becomes the identity and so $\bar{\pi}_\alpha = \bar{\pi}$. Along the chapter we will emphasize these situations by saying that the extended projection $\bar{\pi}$ is univocally determined.

The previous construction give us a reasonable way to define an extension for the space-time covering projection π . However, as shown in Example 1.47, such a map does not send points of \bar{V} to points in $\bar{M} \subset \hat{M}_\emptyset \times \hat{M}_\emptyset$. When the inclusion $\bar{\pi}(\bar{V}) \subset \bar{M}$ holds, we will say that $\bar{\pi}$ is *well defined as a map to \bar{M}* , and \bar{M} will be regarded as its codomain without further mention. Now, we can overcome this problem under the assumptions of Props. 1.18 and 1.19.

Proposition 1.23. *If we assume that the points $(P, F) \in \bar{M}$ with $P \neq \emptyset \neq F$ have lifts in \bar{V} (see Prop. 1.19) and that M does not admit an inextensible sequence $\{x_n\}_n \subset M$ which is either past-directed chronological with future divergent lifts or future-directed chronological with past divergent lifts, then $\bar{\pi}$ is well defined as a map to \bar{M} and it is surjective.*

Proof. Let us begin by showing that $\bar{\pi}$ is well defined as a map to \bar{M} . Take $(\bar{P}, \bar{F}) \in \bar{V}$ an arbitrary point and let us consider $\bar{\pi}((\bar{P}, \bar{F}))$. Observe that there are essentially two possibilities for the projection: Or it has both components non empty, or has one empty component. The former case follows if the initial point (\bar{P}, \bar{F}) has both components non empty or if one component is empty (without loss of generality $\bar{F} = \emptyset$) but there exists (\bar{P}', \bar{F}') with both components non empty G_0 related to (\bar{P}, \emptyset) . In any such cases Prop. 1.18 ensures that $\bar{\pi}((\bar{P}, \bar{F})) \in \bar{M}$

In the latter, no point (\bar{P}', \bar{F}') with both non empty components can be \sim_{G_0} related with (\bar{P}, \bar{F}) . In particular, one of the components of the point has to be empty, say $\bar{F} = \emptyset$ (the other case is analogous). In this case, $\bar{\pi}((\bar{P}, \emptyset)) = (P, \emptyset)$, and so, we have to prove that $P \sim_S \emptyset$. If not, from the completeness of the c-completion (recall Thm. 17 (iii)), the terminal set P should be S -related with a terminal set $F \neq \emptyset$, determining the point $(P, F) \in \bar{M}$. From the hypothesis, there are non empty lifts \bar{P}' and \bar{F}' of P and F such that $(\bar{P}', \bar{F}') \in \bar{V}$. However, we have that $\hat{\pi}(\bar{P}) = \hat{\pi}(\bar{P}')$, and so, that $(\bar{P}, \emptyset) \sim_{G_0} (\bar{P}', \bar{F}')$, a contradiction. In conclusion, $P \sim_S \emptyset$ and the projection $\bar{\pi}$ is well defined as a map to \bar{M} .

For the surjectivity, consider $(P, F) \in \bar{M}$. If (P, F) has both components non empty, then by hypothesis admits a lift on \bar{V} which projects on it. Otherwise, assume without loss of generality that $F = \emptyset$ and take \bar{P} any lift of P . From completeness of the c-completion, there exists \bar{F} such that $(\bar{P}, \bar{F}) \in \bar{V}$. Moreover \bar{F} has to be empty as, otherwise, recalling that $\bar{\pi}$ is well defined as a map to \bar{M} , $P \sim_S \hat{\pi}(\bar{F})$ (which is not possible as $P \sim_S \emptyset$). Hence, any point $(\bar{P}, \bar{F}) \in \bar{V}$ with $\hat{\pi}(\bar{P}) = P$ has $\bar{F} = \emptyset$ and, from the definition of $\bar{\pi}$, we deduce that $\bar{\pi}((\bar{P}, \emptyset)) = (P, \emptyset)$, as desired. \square

Let us remark that the hypothesis of non existence of future sequences with past divergent lifts nor past sequences with future divergent lifts in M , even if it appears to be quite strong, this hypothesis is easily verifiable. In fact, Example 1.48 illustrates how to verify the absence of such sequences, while Cor. 1.40 gives hypothesis that guarantees such absence.

In any case, whenever $\bar{\pi}$ is well defined as a map to \bar{M} and it is surjective, we can proceed in complete analogy with the partial cases and obtain the following commutative diagram:

$$\begin{array}{ccc} \bar{V} & & \\ \bar{i} \downarrow & \searrow \bar{\pi} & \\ \bar{V}/G & \xrightarrow{\bar{j}} & \bar{M} \end{array}$$

where two points in \bar{V} are G -related if they project by $\bar{\pi}$ into the same point of \bar{M} ; and \bar{V}/G denotes the related quotient space. From its definition, \bar{j} defines a bijection between \bar{V}/G and \bar{M} .

As a final remark in this section, simple cases where the map $\bar{\pi}$ is univocally determined are pointed out now.

Lemma 1.24. *Assume that the projection $\pi : V \rightarrow M$ is tame. If $(\bar{P}, \emptyset) \sim_{G_0} (\bar{P}', \bar{F}')$, then $\bar{F}' = \emptyset$ (and analogously for the case (\emptyset, \bar{F})). In particular, the extended map $\bar{\pi}$ is univocally determined (see Rem. 1.22).*

Proof. The result is straightforward, once we recall that in tame projections, if $\hat{\pi}(\bar{P}) = \hat{\pi}(\bar{P}')$, then there exists $g \in G$ such that $\bar{P}' = g\bar{P}$. Therefore, if $\bar{F}' \neq \emptyset$ and $\bar{P}' \sim_S \bar{F}'$, it follows that $\bar{P} = g^{-1}\bar{P}' \sim_S g^{-1}\bar{F}'$, in contradiction with $\bar{P} \sim_S \emptyset$. \square

Proposition 1.25. *Assume that the points $(P, F) \in \bar{M}$ with $P \neq \emptyset \neq F$ have lifts in \bar{V} (see Prop. 1.19), M does not admit an inextensible sequence $\{x_n\}_n \subset M$ which is either past-directed chronological with future divergent lifts or future-directed chronological with past divergent lifts, and \bar{M} is Hausdorff. Then, $\bar{\pi}$ is well defined as a map to \bar{M} , it is surjective and univocally determined.*

Proof. By Prop. 1.23 we have that $\bar{\pi}$ is well defined as a map to \bar{M} and it is surjective, so we only have to show that $\bar{\pi}$ is univocally determined. Having different possible definitions for $\bar{\pi}$ is only possible under the following situation (or its analogous for the future): there exist three points $(\bar{P}, \emptyset), (\bar{P}_1, \bar{F}_1), (\bar{P}_2, \bar{F}_2) \in \bar{V}$ with $\hat{\pi}(\bar{P}) = \hat{\pi}(\bar{P}_1) = \hat{\pi}(\bar{P}_2) = P$ but with $\bar{F}_1 = \check{\pi}(\bar{F}_1) \neq \check{\pi}(\bar{F}_2) = \bar{F}_2$. However, from Prop. 1.18 we know that both $(P, \bar{F}_1), (P, \bar{F}_2)$ belong to \bar{M} , which is not possible since \bar{M} is Hausdorff (observe that any future chronological sequence $\{x_n\}_n$ defining P will converge to both points, see Thm. 17 (ii)). \square

1.3.2 At the chronological level

Let us now study the behaviour of \bar{j} regarding the causal structure. As a first step, we need to define first a chronological relation on \bar{V}/G . For this, we will follow an approach inspired from [36, Section 6.2], where two equivalence classes $\bar{i}((\bar{P}, \bar{F})), \bar{i}((\bar{P}', \bar{F}')) \in \bar{V}/G$ (being $(\bar{P}, \bar{F}), (\bar{P}', \bar{F}') \in \bar{V}$ two arbitrary points) are chronologically related, $\bar{i}((\bar{P}, \bar{F})) \ll \bar{i}((\bar{P}', \bar{F}'))$ if there exist $(\bar{P}_0, \bar{F}_0) \in \bar{i}((\bar{P}, \bar{F}))$ and $(\bar{P}'_0, \bar{F}'_0) \in \bar{i}((\bar{P}', \bar{F}'))$ with $(\bar{P}_0, \bar{F}_0) \ll (\bar{P}'_0, \bar{F}'_0)$ in \bar{V} .

In general, and under the hypothesis that $\bar{\pi}$ is well defined as a map to \bar{M} and it is surjective, we can obtain that both spaces inherit the same causal structure.

Proposition 1.26. *Let $\pi : V \rightarrow M$ a spacetime covering projection and assume that $\bar{\pi}$ is well defined as a map to \bar{M} and it is surjective. Denote by \bar{j} the corresponding map between \bar{V}/G and \bar{M} . Then, the bijection \bar{j} is a chronological isomorphism, that is,*

$$(P, F) \ll (P', F') \iff \bar{j}^{-1}((P, F)) \ll \bar{j}^{-1}((P', F'))$$

Proof. Consider $(P, F), (P', F') \in \bar{M}$ and denote by $(\bar{P}, \bar{F}), (\bar{P}', \bar{F}') \in \bar{V}$ two corresponding lifts. It follows that $\bar{j}^{-1}((P, F)) = \bar{i}((\bar{P}, \bar{F}))$ and $\bar{j}^{-1}((P', F')) = \bar{i}((\bar{P}', \bar{F}'))$.

Assume that $\bar{i}((\bar{P}, \bar{F})) \ll \bar{i}((\bar{P}', \bar{F}'))$ and, without loss of generality, that $(\bar{P}, \bar{F}) \ll (\bar{P}', \bar{F}')$. Then, $\bar{F} \cap \bar{P}' \neq \emptyset$ and from the first bullet point of Prop. 1.5, that $F \cap P' \neq \emptyset$. Therefore, $(P, F) \ll (P', F')$.

For the other implication, assume that $(P, F) \ll (P', F')$, i.e., $F \cap P' \neq \emptyset$ and let $x \in F \cap P'$. As $x \in F$ and $\check{\pi}(\bar{F}) = F$, Prop. 1.5 ensures that there exists a point $p \in V$ with $\pi(p) = x$ such that $p \in \bar{F}$. Reasoning in the same way but fixing this lifted $p \in V$ of x , we can show that there exists

$g \in G$ such that $p \in g\overline{P'}$ (recall that $\hat{\pi}(\overline{P'}) = P'$). In conclusion, $p \in \overline{F} \cap g\overline{P'}$ and so $(\overline{P}, \overline{F}) \ll (g\overline{P'}, g\overline{F'})$. Hence, $\bar{i}((\overline{P}, \overline{F})) \ll \bar{i}((\overline{P'}, \overline{F'})) (= \bar{i}((g\overline{P'}, g\overline{F'})))$. \square

1.3.3 At the topological level

Finally, in this section we will compare the topological structures of both, \overline{V}/G and \overline{M} . Let us start by fixing some notation. \overline{M} and \overline{V} will be endowed with the corresponding chronological topology, while \overline{V}/G will be with the induced quotient topology from \overline{V} . In concordance with Section 1.2, we will denote by L_M the chronological limit on \overline{M} , by L_V the chronological limit on \overline{V} and by L_G the quotient limit operator on \overline{V}/G induced from L_V (recall equation (1.2)).

In spite of the partial cases where the openness of the map \bar{j} is always ensured, in general the map \bar{j} is neither continuous nor open. In fact, the following result summarizes the relevant cases where \bar{j} is well behaved with respect the limit operator.

Proposition 1.27. *Let $\pi : V \rightarrow M$ be a spacetime covering projection and assume that $\overline{\pi}$ is well defined as a map to \overline{M} and it is surjective. Then*

- (a) *If $(\overline{P}, \overline{F}) \in L_V(\overline{\sigma})$ for some sequence $\overline{\sigma} \subset \overline{V}$ with $\overline{P} \neq \emptyset \neq \overline{F}$, then $(P, F) \in L_M(\sigma)$, where $(P, F) = \overline{\pi}((\overline{P}, \overline{F}))$ and $\sigma = \overline{\pi}(\overline{\sigma})$.*
- (b) *If $(P, \emptyset) \in L_M(\sigma)$ (analogously for $(\emptyset, F) \in L_M(\sigma)$) for some sequence $\sigma \subset \overline{M}$, then there exist a subsequence $\kappa \subset \sigma$ and lifts $(\overline{P}, \emptyset)$ and $\overline{\kappa}$ of (P, \emptyset) and κ respectively such that $(\overline{P}, \emptyset) \in L_V(\overline{\kappa})$.*

Proof. Assertion (b) is a direct consequence of (7), Rem. 1.11 and the fact that any lift $(\overline{P}, \overline{F}) \in \overline{\pi}^{-1}((P, \emptyset))$ should have $\overline{F} = \emptyset$, so let us focus on assertion (a). For this, recall that from the definition of the chronological limit, $\overline{P} \in \text{LI}(\{\overline{P}_n\}_n)$ and $\overline{F} \in \text{LI}(\{\overline{F}_n\}_n)$. As the projection preserves contentions, we have that $P \in \text{LI}(\{P_n\}_n)$ and $F \in \text{LI}(\{F_n\}_n)$, which is enough to ensure that $(P, F) \in L_M(\{(P_n, F_n)\}_n)$ (see Prop. 16). \square

The other cases (that is, when $(\overline{P}, \overline{F})$ has one empty component or when $P \neq \emptyset \neq F$) are false in general, as it is proved by Examples 1.45 and 1.51. On the first one there exists a sequence $\{q_n\}_n \subset V$ converging to a point of the form $(\overline{P}, \emptyset)$, while its projection converges to a point (P', \emptyset) with $\hat{\pi}(\overline{P}) = P \subsetneq P'$. On the second example, the sequence $\{x_n\}_n$ converges to (P, F) in \overline{M} , however $\{x_n\}_n$ has no convergent lift on the corresponding \overline{V} .

The first case is directly related with the non continuity of \bar{j} . In fact, we can easily prove that:

Proposition 1.28. *Let $\pi : V \rightarrow M$ be a spacetime covering projection with $\overline{\pi}$ well defined as a map to \overline{M} and surjective. If $\overline{\pi}((\overline{P}, \emptyset)) = (P, \emptyset)$, $\overline{\pi}((\emptyset, \overline{F})) = (\emptyset, F)$ for any IP \overline{P} and IF \overline{F} (so that, in particular, $\overline{\pi}$ is univocally determined, see Rem. 1.22); and M has no sequence with divergent lifts, then, the map $\overline{\pi}$ (and so, \bar{j}) is continuous.*

Proof. To prove the continuity of $\overline{\pi}$ it is enough to show that, given a point $(\overline{P}, \overline{F}) \in \overline{V}$ and a sequence $\{(\overline{P}_n, \overline{F}_n)\}_n \subset \overline{V}$ with $(\overline{P}, \overline{F}) \in L_V(\{(\overline{P}_n, \overline{F}_n)\}_n)$, then $(P, F) \in L_M(\{(P_n, F_n)\}_n)$, where $(P, F) = \overline{\pi}((\overline{P}, \overline{F}))$ and $(P_n, F_n) = \overline{\pi}((\overline{P}_n, \overline{F}_n))$. If $\overline{P} \neq \emptyset \neq \overline{F}$, the result follows from Prop. 1.27 (a). If $\overline{F} = \emptyset$ (the other case is analogous) we have that $\overline{P} \in \hat{L}_V(\{\overline{P}_n\}_n)$ and so, from Prop. 1.14, that $P \in \hat{L}_M(\{P_n\}_n)$. Finally, from hypothesis, $\overline{\pi}((\overline{P}, \emptyset)) = (P, \emptyset) \in \overline{M}$, so $(P, \emptyset) \in L_M(\{(P_n, F_n)\}_n)$. \square

Let us give a closer look to previous proof. Observe that the non existence of divergent lifts is used precisely when we deal with limit points of the form $(\overline{P}, \emptyset)$ or $(\emptyset, \overline{F})$. In this case, $\hat{\pi}(\overline{P}) := P$ does not belong to $\hat{L}_M(\{P_n\}_n)$ if it is not a maximal IP in $\text{LS}(\{P_n\}_n)$ and then, necessarily, it

should exist another IP P' with $P \subsetneq P' \in \hat{L}_M(\{P_n\}_n)$ (up to a subsequence). Therefore, if we assume that \bar{M} has no lightlike boundary points (and conditions ensuring that $(P, \emptyset) \in \bar{M}$), such a situation is not possible and the continuity of $\bar{\pi}$ follows. In conclusion we have:

Proposition 1.29. *Let $\pi : V \rightarrow M$ be a spacetime covering projection satisfying: (i) $\bar{\pi}$ is well defined as a map to \bar{M} and it is surjective, (ii) $\bar{\pi}((\bar{P}, \emptyset)) = (P, \emptyset)$ and $\bar{\pi}((\emptyset, \bar{F})) = (\emptyset, F)$ for any IP \bar{P} and IF \bar{F} (hence $\bar{\pi}$ is univocally determined, see Rem. 1.22); and (iii) \bar{M} has no lightlike boundary points. Then, the map $\bar{\pi}$ (and so, \bar{j}) is continuous.*

Remark 1.30. Observe that, in spite of Cor. 1.15, here we do not need to impose that the boundary \bar{M} has only spatial boundary points; indeed, we can also include timelike ones. The reason is simple: unlike partial boundaries, the total c -completion takes into account more information for each point in the boundary, specially with timelike boundary points where both, the future and past components, are non empty. In fact, such an additional information lets us simplify the definition of the limit operator (see Prop. 16), as we have used on the proof of Prop. 1.28.

As we have mentioned at the beginning of the section, and in spite of the continuity of \hat{j} and \check{j} , the openness of the partial maps \hat{j} and \check{j} is not enough to ensure the openness of \bar{j} , as we can see on Example 1.51. This means that an additional condition has to be imposed to obtain the openness of \bar{j} . In this sense, we will consider the *finite chronology* condition of whose properties will be studied in the following section.

1.3.4 Group actions with the finite chronology property

First of all, let us introduce the definition of finite chronology.

Definition 1.31. *Let V be a spacetime and G a group of isometries. We will say that the pair (V, G) is finitely chronological if given two points $p, q \in V$ with $p \ll q$, there exists only a finite number of elements $g \in G$ such that $p \ll gq$.*

The finite chronology property will be enough to ensure the openness of \bar{j} and it will also simplify the conditions to ensure when the map $\bar{\pi}$ is well defined as a map to \bar{M} , it is univocally determined and surjective. However, such a condition will not be enough to prove the continuity of \bar{j} or \check{j} , as it is showed by Example 1.47. Let us begin with a crucial lemma:

Lemma 1.32. *Assume that (V, G) is finitely chronological and consider a point $p \in V$, a past-directed (resp. future-directed) chronological chain $\{p_n\}_n \subset V$ and a sequence $\{g_n\}_n \subset G$. If for all $n \in \mathbb{N}$, $p \ll g_n p_n$ (resp. $g_n p_n \ll p$), then there exists $n_0 \in \mathbb{N}$ and a finite family $\{h_1, \dots, h_r\} \subset G$ such that for $n \geq n_0$, $g_n = h_i$ for some $i = 1, \dots, r$. In fact, n_0 can be taken in such a way that each h_i occurs infinitely often, and so, $\{h_1, \dots, h_r\} \subset G(p, \{p_n\}_n)$ (resp. $\{h_1, \dots, h_r\} \subset G(\{p_n\}_n, p)$), where*

$$\begin{aligned} G(p, \{p_n\}_n) &:= \{g \in G : p \ll g p_n \text{ for all } n\} \\ G(\{p_n\}_n, p) &:= \{g \in G : g p_n \ll p \text{ for all } n\} \end{aligned}$$

is a non empty finite set.

Proof. The proof follows essentially by recalling that, for a fixed $k_0 \in \mathbb{N}$ and $n \geq k_0$,

$$p \ll g_n p_n \ll g_n p_{k_0}. \quad (1.8)$$

In particular, as there exists a finite number of elements $g \in G$ such that $p \ll g p_{k_0}$, g_n should belong to a finite family of elements in G for n big enough. Moreover, we can take

$\{h_1, \dots, h_r\} \subset G$ such that, for all h_i , there exists a subsequence $\{g_{n_k^i}\}_k$ with $g_{n_k^i} = h_i$. In particular, there exists n_0 such that for each $n \geq n_0$ there exists $i \equiv i(n)$ with $g_n = h_i$.

For the second assertion, recall that the set $G(p, \{p_n\}_n)$ is finite by the finitely chronological property. Now, we will show that $\{h_1, \dots, h_r\} \subset G(p, \{p_n\}_n)$. As we have stated before, for each h_i there exists a subsequence $\{g_{n_k^i}\}_k \subset \{g_n\}_n$ such that $g_{n_k^i} = h_i$, and therefore satisfying $p \ll g_{n_k^i} p_{n_k^i} = h_i p_{n_k^i}$ for all k . Now observe that, for any $m \in \mathbb{N}$, we can take $k \in \mathbb{N}$ such that $m < n_k^i$, and it follows that $p \ll h_i p_{n_k^i} \ll h_i p_m$ (as $\{p_n\}_n$ is past-directed chronological chain); concluding then that $h_i \in G(p, \{p_n\}_n)$. \square

If we consider two points $p, p' \in V$ with $p \ll p'$, then it follows that $G(p', \{p_n\}_n) \subseteq G(p, \{p_n\}_n)$. This relation allows us to prove that the lifts of terminal sets are well behaved with respect to the future and common pasts, at least when (V, G) is finitely chronological. Concretely,

Lemma 1.33. *Consider an IP P and an IF F on M satisfying that $P \subset \downarrow F$; and take \bar{P}, \bar{F} the corresponding lifts. If (V, G) is finitely chronological then the set $G(\bar{P}, \bar{F})$ defined by*

$$G(\bar{P}, \bar{F}) = \{g \in G : \bar{P} \subset \downarrow g \bar{F}\} \quad (1.9)$$

is non empty and finite.

Proof. As a first step, we are going to characterize the set $G(\bar{P}, \bar{F})$ in terms of the sequences defining \bar{P} and \bar{F} . In this sense, let $\{x_n\}_n$ and $\{y_n\}_n$ be chronological sequences defining P and F resp., and $\{p_n\}_n, \{q_n\}_n$ the corresponding chronological lifts defining \bar{P} and \bar{F} . Observe that the following chain of equivalences follows

$$\begin{aligned} g \in G(\bar{P}, \bar{F}) &\iff \bar{P} \subset \downarrow g \bar{F} \\ &\iff p_n \in g \bar{F} \text{ for all } n \in \mathbb{N} \\ &\iff p_n \ll g q_m \text{ for all } n, m \in \mathbb{N} \\ &\iff g \in G(p_n, \{q_m\}_m) \text{ for all } n \in \mathbb{N} \end{aligned}$$

In particular,

$$G(\bar{P}, \bar{F}) = \bigcap_{n \in \mathbb{N}} G(p_n, \{q_m\}_m). \quad (1.10)$$

As a second step, recall that from hypothesis $P \subset \downarrow F$, and so, $x_n \ll y_m$ for all $n, m \in \mathbb{N}$. Hence, Prop. 1.5 ensures that there exists a sequence $\{g_m\}_m \subset G$ such that $p_n \ll g_m q_m$ and so, from Lemma 1.32, $G(p_n, \{q_m\}_m)$ is non empty and finite for all n .

Then, $G(\bar{P}, \bar{F})$ is the intersection of a numerable family of non empty and finite sets ordered by $G(p_{n+1}, \{q_m\}_m) \subset G(p_n, \{q_m\}_m)$. Therefore, it is a non empty and finite set. \square

In particular, and as a consequence of Lemma 1.33 and Props. 1.19 and 1.23, we have that:

Corollary 1.34. *Let $\pi : V \rightarrow M$ be a spacetime covering with (V, G) finitely chronological and assume that M does not admit an inextensible sequence $\{x_n\}_n \subset M$ which is either past-directed chronological with future divergent lifts or future-directed chronological with past divergent lifts. Then, the map $\bar{\pi} : \bar{V} \rightarrow \bar{M}$ is well defined as a map to \bar{M} and it is surjective.*

At this point a natural question arises at the point set level: is there any relation between $\bar{\pi}^{-1}((P, F))$ and the set $G(\bar{P}, \bar{F})$? Intuitively, one can expect that for a fixed lift \bar{P} , the set $G(\bar{P}, \bar{F})$ determines all the pairs of the form $(\bar{P}, g \bar{F}) \in \bar{V}$ with projection (P, F) . However, as we recall in Rem. 1.20, it is not clear that, in general, all the lifts preserving the relation with the common future (or past) are S -related. Again, the finite chronology condition will be enough for this, as we will see on Lemma 1.37. In order to prove such a lemma, we need first the following technical result:

Lemma 1.35. Let $\bar{P}, \bar{P}' \in \hat{V}$ (resp. $\bar{F}, \bar{F}' \in \check{V}$) be two points of the future (past) causal completion projecting to the same set $P \in \hat{M}$ ($F \in \check{M}$). Suppose one of the following situations:

(H1) (V, G) is finitely chronological and there exists $p \in V$ such that $\bar{P}' \subset I^-(p)$ ($\bar{F}' \subset I^+(p)$).

(H2) G is finite.

Then there exists $h' \in G$ such that $\bar{P} = h' \bar{P}'$ ($\bar{F} = h' \bar{F}'$). In particular, it follows that if G is finite the projection π is future (past) tame.

Proof. Let $\{p_n\}_n, \{p'_n\}_n$ be future chronological chains defining \bar{P} and \bar{P}' resp. As both sets project onto the same P , it follows that the projection of such sequences $\{x_n\}_n, \{x'_n\}_n$ generate P . In particular, for each n there exists $m(n)$ big enough such that $x_n \ll x'_{m(n)}$. We will consider $\{m(n)\}_n$ a strictly increasing sequence, so $\{x'_{m(n)}\}_n$ is a subsequence of $\{x'_n\}_n$ and generates the same P (and, accordingly, $\{p'_{m(n)}\}_n$ generates \bar{P}'). From Prop. 1.5 it follows that there exists a sequence $\{g_n\}_n \subset G$ such that $g_n p_n \ll p'_{m(n)}$ for all n .

Now observe that, in either situation (H1) nor (H2), and up to a subsequence, $\{g_n\}_n$ can be considered a constant sequence (say $g_n = h \in G$ for all n). In the case that G is finite the argument is straightforward. In the other case, recall that from (H1) we have that $g_n p_n \ll p'_{m(n)} \ll p$, and so the assertion follows from Lemma 1.32. Therefore, $h p_n \ll p'_{m(n)}$ for all n , and hence, $h \bar{P} \subset \bar{P}'$. By interchanging the roles of \bar{P}' and $h \bar{P}$ (recall that, now, $h \bar{P} \subset \bar{P}' \subset I^-(p)$), we find another \tilde{h} such that $\tilde{h} \bar{P}' \subset h \bar{P}$ or, by considering $h' = h^{-1} \tilde{h}$, that $h' \bar{P}' \subset \bar{P}$.

Now, we can join both contentions $h \bar{P} \subset \bar{P}'$ and $h' \bar{P}' \subset \bar{P}$ together in the following way

$$g \bar{P} \subset h' \bar{P}' \subset \bar{P} \tag{1.11}$$

for $g = h' h$; and then construct the chain:

$$\bar{P} \supset g \bar{P} \supset (g)^2 \bar{P} \supset \dots \supset (g)^n \bar{P} \supset \dots$$

where $(g)^i$ denotes the i -th iteration of the action by g . Now observe that under the hypothesis of the lemma, there exists i_0 such that $(g)^{i_0} = e$. This assertion is again straightforward under the assumption of G finite, so let us focus on the hypothesis (H1). If by contradiction $(g)^i \neq (g)^j$ for all $i \neq j$, and recalling that $\bar{P} \subset I^-(p)$, we deduce that $(g)^i \bar{P} \subset I^-(p)$ for all i . which contradicts that (V, G) is finitely chronological (the point p will be chronologically related with $(g)^i q$ for any $q \in \bar{P}$ and $i \in \mathbb{N}$).

Summarizing we deduce that $g \bar{P} = \bar{P}$ and from (1.11) we obtain that $\bar{P} = h' \bar{P}'$, as desired. \square

Remark 1.36. Note that in previous proof the following statement has been implicitly proved: if $g \bar{P} \subset \bar{P}$ for some $g \in G$, and either (H1) or (H2) holds on V , then $g \bar{P} = \bar{P}$ (analogously for future sets).

Lemma 1.37. Assume that (V, G) is finitely chronological. If \bar{P} and \bar{F} are terminal sets with $\hat{\pi}(\bar{P}) = P \sim_S F = \hat{\pi}(\bar{F})$, then $\bar{P} \sim_S g \bar{F}$ for all $g \in G(\bar{P}, \bar{F})$.

Proof. Assume without loss of generality that $e \in G(\bar{P}, \bar{F})$, and so, that $\bar{P} \subset \downarrow \bar{F}$. By contradiction, let us assume that \bar{P} is not S -related with \bar{F} . Recalling Rem. 1.20, we ensure the existence of a terminal set \bar{P}' with $\bar{P} \subsetneq \bar{P}' \subset \downarrow \bar{F}$ and satisfying that $\hat{\pi}(\bar{P}) = \hat{\pi}(\bar{P}')$. As (V, G) is finite chronological and there exists $p \in V$ such that $\bar{P}', \bar{P} \subset I^-(p)$ (take any $p \in \bar{F}$), Lemma 1.35 ensures that there exists $h \in G$ such that $\bar{P}' = h \bar{P}$. But then, recalling Rem. 1.36, we arrive to a contradiction with $\bar{P} \subsetneq \bar{P}' = h \bar{P}$. \square

The technical Lemma 1.35 allows us to prove that $\bar{\pi}$ is univocally determined, as it follows from the following result (recall also Rem. 1.22):

Proposition 1.38. *Assume that (V, G) is finitely chronological. If $(\bar{P}, \emptyset) \sim_{G_0} (\bar{P}', \bar{F}')$, then $\bar{F}' = \emptyset$ (an analogous result follows for a pair (\emptyset, \bar{F})).*

Proof. Assume by contradiction that $(\bar{P}, \emptyset) \sim_{G_0} (\bar{P}', \bar{F}')$ with $\bar{F}' \neq \emptyset$. By recalling that both sets \bar{P} and \bar{P}' projects onto the same set P in \hat{M} , and that for any $p \in \bar{F}'$, $\bar{P}' \subset I^-(p)$; we can apply Lemma 1.35 (H1) deduce the existence of $h' \in G$ such that $\bar{P} = h' \bar{P}'$. Since G acts by isometries, it follows that $\bar{P} = h' \bar{P}' \sim_S h' \bar{F}'$, which is a contradiction to $\bar{P} \sim_S \emptyset$. In conclusion, $\bar{F}' = \emptyset$. \square

With all previous machinery set, we are now in conditions to prove the openness of \bar{j} under the assumption of finite chronology:

Proposition 1.39. *Let $\pi : V \rightarrow M$ be spacetime covering projection with (V, G) finitely chronological and assume that $\bar{\pi}$ is well defined as a map to \bar{M} and it is surjective. Then, the univocally determined map $\bar{\pi}$ induces an open map \bar{j} from \bar{V}/G to \bar{M} .*

Proof. Let $\{(P_n, F_n)\}_n \subset \bar{M}$ be a sequence and $(P, F) \in \bar{M}$ a point such that $(P, F) \in L_M(\{(P_n, F_n)\}_n)$. Our aim is to show that, up to a subsequence, (P_n, F_n) and (P, F) admit lifts (\bar{P}'_n, \bar{F}'_n) and (\bar{P}, \bar{F}) with $(\bar{P}', \bar{F}') \in L_V(\{(\bar{P}'_n, \bar{F}'_n)\}_n)$, and hence, that $\bar{j}^{-1}((P, F)) \in L_G(\{\bar{j}^{-1}(P_n, F_n)\}_n)$ (recall (1.2)). Observe that the case where F or P is empty follows from Prop. 1.27 (b), so we only need to focus on the case where both sets are non empty.

Assume that $P \neq \emptyset \neq F$ and let $\bar{P}, \bar{F}, \bar{P}_n, \bar{F}_n$ be some fixed lifts of P, F, P_n, F_n respectively. Consider $\{x_n\}_n$ and $\{y_n\}_n$ chronological sequences defining P and F and, as usual, denote by $\{p_n\}_n$ and $\{q_n\}_n$ the corresponding lifts defining \bar{P} and \bar{F} . Let us denote by $\{m(n)\}_n$ a sequence in \mathbb{N} with $m(n+1) \geq m(n) + 1$ and satisfying that $x_n \in P_{m(n)}$ and $y_n \in F_{m(n)}$. Now, as $x_n \in P_{m(n)}$, Prop. 1.5 ensures that $p_n \in g_n \bar{P}_{m(n)}$ for some $g_n \in G$. From Lemma 1.33, we know that the set $G(g_n \bar{P}_{m(n)}, \bar{F}_{m(n)})$ is non empty and, from Lemma 1.37, that for any $g'_n \in G(g_n \bar{P}_{m(n)}, \bar{F}_{m(n)})$, $g_n \bar{P}_{m(n)} \sim_S g'_n \bar{F}_{m(n)}$. Finally, again from Prop. 1.5 and $y_n \in F_{m(n)}$, there exists $h_n \in G$ such that $h_n q_n \in g'_n \bar{F}_{m(n)}$.

Now, let us observe that from $g_n \bar{P}_{m(n)} \subset\downarrow g'_n \bar{F}_{m(n)}$, it follows that $p_n \ll h_n q_n$. In particular, we have the chain

$$p_1 \ll p_n \ll h_n q_n$$

and then, from Lemma 1.32, we can ensure that, up to a subsequence, $\{h_n\}_n$ is constant, say $h_n = h \in G$ for all n . In particular, for any i and all $n > i$, it follows that

$$p_i \ll p_n \ll h q_n.$$

In particular, $\bar{P} \subset\downarrow h \bar{F}$ and so $h \in G(\bar{P}, \bar{F})$. Hence, Lemma 1.37 ensures that both sets \bar{P} and $h \bar{F}$ are S-related. Summarizing:

- The pairs $(\bar{P}, h \bar{F})$ and $(g_n \bar{P}_{m(n)}, g'_n \bar{F}_{m(n)})$ belong to \bar{V} .
- $\bar{P} \subset \text{LI}(\{g_n \bar{P}_{m(n)}\}_n)$ and $h \bar{F} \subset \text{LI}(\{g'_n \bar{F}_{m(n)}\}_n)$, thus (see Prop. 16)

$$(\bar{P}, h \bar{F}) \in L_V(\{g_n \bar{P}_{m(n)}, g'_n \bar{F}_{m(n)}\}_n).$$

In conclusion, and always up to a subsequence, if $(P, F) \in L_M(\{(P_n, F_n)\}_n)$ we can always obtain appropriate lifts $(\overline{P'}, \overline{F'})$ and $\{(\overline{P'}_n, \overline{F'}_n)\}_n$ such that $(\overline{P'}, \overline{F'}) \in L_V(\{(\overline{P'}_n, \overline{F'}_n)\}_n)$. The result follows then as a consequence of Prop. 1.3 applied to \bar{j}^{-1} . \square

As a final remark of this section, we will show how finite chronology lets us simplify some of our previous hypothesis regarding the definition and continuity of \bar{j} . In fact, the condition of M having no sequence with divergent lifts (which is almost equivalent to the continuity of $\hat{\pi}$ and $\check{\pi}$, recall Prop. 1.14) imposed in Prop. 1.23 can be substituted by a topological requirement on \hat{V} and \check{V} respectively:

Corollary 1.40. *Assume that (V, G) is finitely chronological and that both \hat{V}, \check{V} are Hausdorff. Then, $\bar{\pi}$ is well defined as a map to \overline{M} , it is surjective and univocally determined.*

Proof. We only need to show, according to Cor. 1.34, that any past-directed chronological chain on M has no future divergent lifts (the other case will be completely analogous). Let $\{y_n\}_n$ be a past-directed chronological chain and consider $\{q_n\}_n$ a past chronological sequence in V with $\pi(q_n) = y_n$ and defining an IF \overline{F} . Suppose that there exist $\{h_n\}_n, \{g_n\}_n \subset G$ and $\overline{P}, \overline{P'} \in \hat{V}$ such that $\overline{P} \in \hat{L}_V(\{I^-(h_n q_n)\}_n)$ and $\overline{P'} \in \hat{L}_V(\{I^-(g_n q_n)\}_n)$.

Take $p \in \overline{P}$. From $\overline{P} \in \hat{L}_V(\{I^-(h_n q_n)\}_n)$ we have that $p \ll h_n q_n$ for n big enough. As (V, G) is finitely chronological, Lemma 1.32 ensures that, up to a subsequence, $h_n = h_0$ for some fixed $h_0 \in G$. Reasoning in the same way with $\overline{P'}$ and $\{g_n\}_n$, we can ensure that, up to a subsequence, $g_n = g_0$ for some fixed $g_0 \in G$.

Hence, we have that $\overline{P} \in \hat{L}_V(\{I^-(h_0 q_n)\}_n)$ and $\overline{P'} \in \hat{L}_V(\{I^-(g_0 q_n)\}_n)$ and, from the first inclusion, we deduce that $(g_0 h_0^{-1})\overline{P} \in \hat{L}_V(\{I^-(g_0 q_n)\}_n)$. As \hat{V} is Hausdorff, then $(g_0 h_0^{-1})\overline{P} = \overline{P'}$ and both sets project onto the same set in \hat{M} . In conclusion, $\{y_n\}_n$ cannot admit future divergent lists. Finally, $\bar{\pi}$ is univocally determined as it follows from Prop. 1.38. \square

At the topological level, we also have to impose some conditions on \overline{M} , obtaining:

Corollary 1.41. *Assume that (V, G) is finitely chronological, \hat{V} and \check{V} are Hausdorff and \overline{M} has no lightlike boundary points. Then, $\overline{V}/G \cong \overline{M}$, i.e., both \overline{V}/G and \overline{M} are homeomorphic and chronologically isomorphic.*

Proof. From Cor. 1.40 follows that $\bar{\pi}$ is well defined as a map to \overline{M} , it is surjective and univocally determined. Then, Props. 1.26 and 1.39 ensure, that \bar{j} is both a chronological isomorphism and an open map.

Hence, it only remains to show that \bar{j} is continuous. But this follows from Prop. 1.29, recalling that Prop. 1.38 ensures that $\bar{\pi}(\overline{P}, \emptyset) = (P, \emptyset)$ and $\bar{\pi}(\emptyset, \overline{F}) = (\emptyset, F)$. \square

Ideally, one would like to impose conditions only on \overline{V} in order to ensure that \overline{V}/G and \overline{M} have the same structures. For example, and in the spirit of Cor. 1.41, we would like to impose on \overline{V} the non-existence of lightlike boundary points to obtain the non-existence of lightlike boundary points on \overline{M} , and therefore the continuity of \bar{j} . However, the lack of lightlike boundary points in \overline{V} is not enough to ensure that the same property holds on \overline{M} (see Example 1.52). Nevertheless the situation is very controlled and it is related again to the existence of a very particular class of divergent lifts. In fact, we can prove that (compare with Prop. 1.13):

Corollary 1.42. *Let $\pi : V \rightarrow M$ be a spacetime projection. Assume that $\bar{\pi}$ is well defined as a map to \overline{M} , it is surjective and it satisfies that $\bar{\pi}(\overline{P}, \emptyset) = (P, \emptyset)$ and $\bar{\pi}(\emptyset, \overline{F}) = (\emptyset, F)$ (hence univocally determined, see Rem. 1.22) for any IP \overline{P} and IF \overline{F} . If \overline{V} has no lightlike boundary points and the G -orbits for both \hat{V} and \check{V} are closed (with the corresponding topologies), then \overline{M} has no lightlike boundary points.*

Proof. Assume by contradiction that \overline{M} has lightlike boundary points, that is, that there exists $(P, \emptyset) \in \overline{M}$ and $P' \in \hat{M}$ such that $P \subsetneq P'$ (the case with past sets will be analogous). Let $\{x_n\}_n$ and $\{x'_n\}_n$ be chronological chains generating P and P' resp. and consider \overline{P} , \overline{P}' , $\{p_n\}_n$ and $\{p'_n\}_n$ the corresponding lifts on \hat{V} . From hypothesis, it follows that $(\overline{P}, \emptyset) \in \overline{V}$.

As $P \subset P'$ we deduce that, for all n , $x_n \ll x'_{n'}$ with n' big enough, so Prop. 1.5 ensures that there exists g_n such that $p_n \ll g_n p'_{n'} \in g_n \overline{P}'$. It follows then that $\overline{P} \subset \text{LI}(\{g_n \overline{P}'\}_n)$. Moreover, it also follows that $\overline{P} \in \hat{L}_V(\{g_n \overline{P}'\}_n)$ as, otherwise, there exists \overline{P}'' such that $\overline{P} \subsetneq \overline{P}''$ and this is not possible as \overline{V} has no lightlike boundary points.

Finally, and from the hypothesis that the G -orbits are closed on \hat{V} with the future chronological topology, it follows that $\overline{P} \in \{g \overline{P}'\}_{g \in G}$, i.e., there exists $g_0 \in G$ such that $\overline{P} = g_0 \overline{P}'$. In conclusion, and taking projections, we obtain that $P = P'$, a contradiction. \square

As a consequence of Corollaries 1.40, 1.41 and 1.42, we obtain the following result:

Corollary 1.43. *Assume that (V, G) is finitely chronological, \overline{V} has no lightlike boundary points and \hat{V} and \check{V} are Hausdorff and have closed G -orbits. Then, $\overline{V}/G \cong \overline{M}$, i.e., both \overline{V}/G and \overline{M} are homeomorphic and chronologically isomorphic.*

Summarizing, we have our main theorem:

Theorem 1.44. *Let $\pi : V \rightarrow M$ be a spacetime covering projection and consider $\overline{\pi} : \overline{V} \rightarrow \hat{M}_\emptyset \times \check{M}_\emptyset$ one extension map as defined on Defn. 1.21 (see also Rem. 1.22). Then:*

(PS1) *If M does not admit an inextensible sequence $\{x_n\}_n \subset M$ which is either past-directed chronological with future divergent lifts nor future-directed chronological with past divergent lifts; and any $(P, F) \in \overline{M}$ with $P \neq \emptyset \neq F$ admits a lift on \overline{V} (in particular if (V, G) is finitely chronological, see Defn. 1.31), then the projection $\overline{\pi}$ is well defined as a map to \overline{M} and it is surjective.*

(PS2) *If, in addition, the projection π is tame (recall Defn. 1.8) or (V, G) is finite chronological (see Defn. 1.31), $\overline{\pi}$ is univocally determined (see Rem. 1.22) by*

$$\overline{\pi}((\overline{P}, \overline{F})) = (\hat{\pi}(\overline{P}), \check{\pi}(\overline{F}))$$

where $\hat{\pi}(\emptyset) = \check{\pi}(\emptyset) = \emptyset$.

(PS3) *Finally, if (V, G) is finitely chronological and both \hat{V} , \check{V} are Hausdorff then the projection $\overline{\pi}$ is well defined as a map to \overline{M} , it is surjective and univocally determined.*

Moreover, when the map $\overline{\pi}$ is well defined as a map to \overline{M} and it is surjective, it defines the following relation between points in \overline{V} : two points are \sim_G -related if they project onto the same point in \overline{M} . Then, denoting by \overline{V}/G the quotient space, we obtain the following commutative diagram:

$$\begin{array}{ccc} \overline{V} & & \\ \bar{\imath} \downarrow & \searrow \overline{\pi} & \\ \overline{V}/G & \xrightarrow{\bar{\jmath}} & \overline{M} \end{array}$$

where $\bar{\imath}$ is the natural projection to the quotient and $\bar{\jmath}$ is the induced bijection.

At the chronological level, and once an appropriate chronological relation is defined on \overline{V}/G (see Section 1.3.2), it follows that

(CH) the map \bar{j} is a chronological isomorphism.

Finally, at the topological level, \bar{j} satisfies the following properties:

(TP1) The map \bar{j} is continuous if one of the following hypotheses hold:

- (i) $\bar{\pi}$ satisfies that $\bar{\pi}((\bar{P}, \emptyset)) = (P, \emptyset)$ and $\bar{\pi}((\emptyset, \bar{F})) = (\emptyset, F)$ (this follows if, for instance, π is tame or (V, G) is finite chronological); and M has no sequence with (future or past) divergent lifts.
- (ii) $\bar{\pi}((\bar{P}, \emptyset)) = (P, \emptyset)$, $\bar{\pi}((\emptyset, \bar{F})) = (\emptyset, F)$ and \bar{M} has no lightlike boundary points (see Defn. 13).

(TP2) If (V, G) is finite chronological, the map \bar{j} is open.

In particular, $\bar{\pi}$ is well defined as a map to \bar{M} , it is surjective, univocally determined and induces a homeomorphism and chronological isomorphism between \bar{V}/G and \bar{M} if one of the following assertions is satisfied :

- (a) (V, G) is finite chronological and M admits no sequence with (future or past) divergent lifts.
- (b) (V, G) is finitely chronological, both \hat{V}, \check{V} are Hausdorff and \bar{M} has no lightlike boundary points.
- (c) (V, G) is finitely chronological, \bar{V} has no lightlike boundary points, and both \hat{V}, \check{V} are Hausdorff and have closed G -orbits. In particular, if π is (future and past) tame and there are no constant sequences with divergent lifts in M , then the G -orbits in \hat{V} and \check{V} will be closed.

Proof. At the point set level, the first assertion on (PS1) is proved on Prop. 1.23 and the second one follows from Prop. 1.19 and Lemma 1.33. (PS2) is a consequence of Rem. 1.22, Lemma 1.24 and Prop. 1.38; while (PS3) is proved in Cor. 1.40.

At the chronological level, assertion (CH) is proved on Prop. 1.26.

At the topological level, (TP1) (i) is proved in Prop. 1.28, (TP1) (ii) is Prop. 1.29. The conditions over the projection of pairs (\bar{P}, \emptyset) and (\emptyset, \bar{F}) remarked in (TP1) are proved when π is tame or (V, G) finitely chronological by Lemma 1.24 or by Prop. 1.38 respectively. Finally, (TP2) follows from Prop. 1.39.

For the last assertions, $\bar{\pi}$ being univocally determined is a consequence of the finite chronology and (PS2). (a) follows from (PS1), (CH), (TP1) (i) and (TP2), while for (b) we have to consider (PS3) and (TP1) (ii) instead of (PS1) and (TP1) (i). The last assertion (c) is proved in Cor. 1.43, recalling that the closedness of the G -orbits under π tame is proved in Prop. 1.13. \square

1.4 On the optimality of the results: some examples

Along this section, we will include some examples showing that our main results are optimal. It is worth pointing out that in all the examples $\#L_M(\sigma)$ will be bounded, and so, according to Lemma 1.4, L_M will be of first order UTS. This is specially relevant recalling Prop. 1.14, as it means that in all our examples the non existence of divergent lifts characterize the continuity of $\hat{\pi}$ and $\check{\pi}$.

Let us start with the example due to Harris where \hat{j} is not continuous. Here, we will include only the main properties of his example, referring the reader to [56] for details.

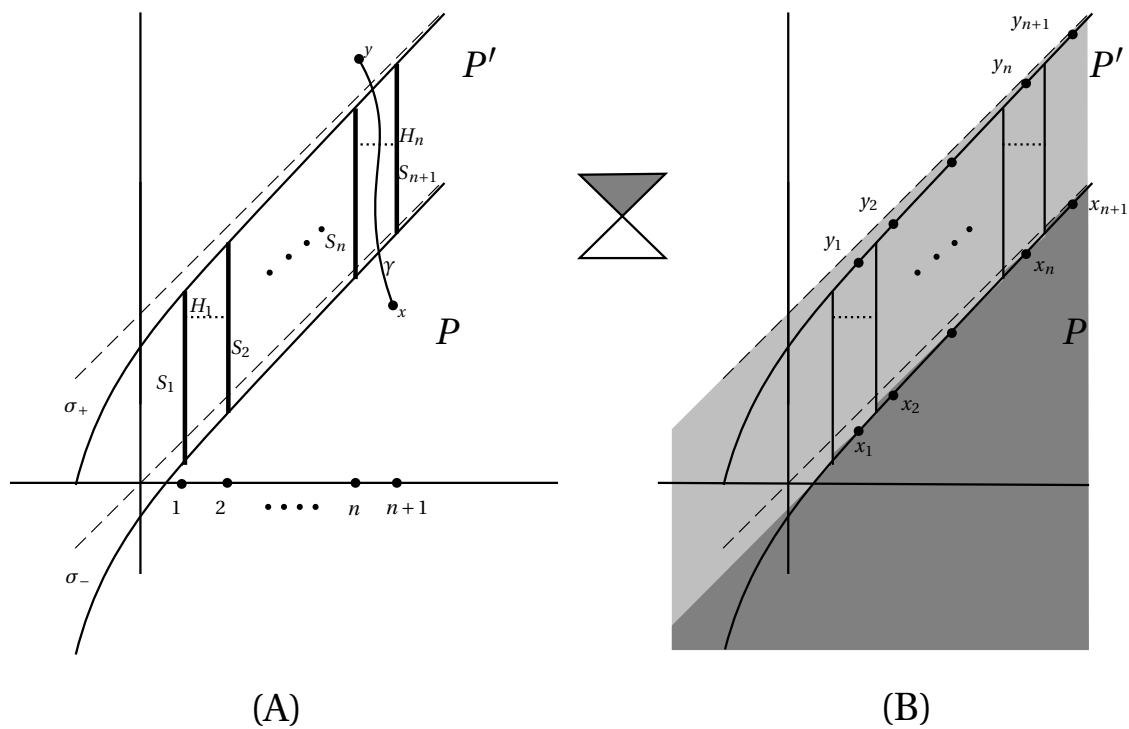

Figure 1.1: The spacetime M is constructed in the following way: Consider in \mathbb{L}^2 two timelike curves σ_- and σ_+ approaching two parallel lightlike lines, as we can see in (A). M is obtained by removing from \mathbb{L}^2 the segments S_n obtained by joining vertically the points $\sigma_-(n)$ and $\sigma_+(n)$. The universal cover V of M contains then a numerable family of copies of M glued along the segments H_i coherently (see details on Example 1.45 and [56]).

Example 1.45. (Behaviour of the universal cover and non-continuity of $\hat{\pi}$) In this example we will see: First, the main properties about the universal cover of a spacetime M where we have removed a numerable family of compact segments (these properties will be used frequently on the forthcoming examples). Second, a case where $\hat{\pi}$ (and so, \hat{j}) is non-continuous. Finally, that \hat{V}/\hat{G} is not a T_1 -topological space.

Let us consider a spacetime M as in the Fig. 1.1, and let V denote its universal cover. As it is described in the last example of [56], V contains a numerable family of copies of M , that we will denote by $\{n\} \times M$ with $n \in \mathbb{Z}$, glued coherently along the horizontal segments H_n . For a given element $x \in M$, let us denote by p its lift in V laying in the fibre $\{0\} \times M$. We will also denote by $n \cdot p$ the lift of x in the fibre $\{n\} \times M$ (i.e., $p \equiv 0 \cdot p$).

In order to understand how the fibres are glued along H_n , let us analyse how the lifts of curves behave. Consider γ a curve on M as it is showed in Fig. 1.1 (A), which is a timelike curve joining two points x and y . Let p and q be the corresponding lifts in the fibre $\{0\} \times M$ and consider $\bar{\gamma}$ a lift of γ on V with start point $m \cdot p$. The fibres are glued in such a way that, as γ intersects the segment H_n , the lifted curve $\bar{\gamma}$ moves from the fibre $\{m\} \times M$ to $\{m+n\} \times M$, being $(m+n) \cdot q$ its final point.

Once we have pointed out this behaviour, let us observe the particularities of the example regarding the continuity of $\hat{\pi}$. Let us observe now Fig. 1.1 (B), where we have two TIPs $P \subsetneq P'$ defined by the sequences $\{x_n\}_n$ and $\{y_n\}_n$ (P is filled in dark grey, while P' has a lighter grey). Consider p_n and q_n lifts of x_n and y_n resp. laying in the fibre $\{0\} \times M$. It is not difficult to observe, due to the behaviour described before, that $m \cdot p_n \ll m \cdot q_n$ for any $m \in \mathbb{N}$. In fact, it follows that

$$m \cdot p_n \ll (m+n) \cdot q_n \quad \text{for all } n \in \mathbb{N}$$

as we can consider timelike curves on M joining x_n with y_n and intersecting H_n . From this, we can prove that: (a) the sequence $\bar{\sigma} = \{I^-(q_n)\}_n$ has \bar{P}' (the lift of P' on the fibre $\{0\} \times M$) on its limit, (b) the sequence $\{I^-(n \cdot q_n)\}_n$ has \bar{P} on its limit (the inclusion on the inferior limit is straightforward, while the proof of the maximal character is detailed in [56]) and (c) $\hat{\pi}(\bar{P}) = P \subsetneq P' = \hat{\pi}(\bar{P}')$. In conclusion, and recalling Prop. 1.14, $\hat{\pi}$ is not continuous.

As a final observation, let us consider the future causal completion of the universal cover V (which is a T_1 topological space) and its quotient space \hat{V}/\hat{G} , where $G = \pi_1(M)$ is the fundamental group of M acting on V . Consider $\bar{P}' \in \hat{V}$ and its corresponding class $[\bar{P}']$ in the quotient space \hat{V}/\hat{G} . It is now straightforward to see that $\bar{P}' \in \hat{L}_V(\{\bar{P}'\}_n)$ and $\bar{P} \in \hat{L}_V(\{n \cdot \bar{P}'\}_n)$. Hence, recalling the definition of L_Q (see (1.2)), it follows that both $[\bar{P}]$ and $[\bar{P}']$ belong to $L_Q(\{[\bar{P}']\}_n)$, making \hat{V}/\hat{G} a non T_1 topological space.

Example 1.46. (Optimality of Prop. 1.23) The following example shows that a point $(\bar{P}, \emptyset) \in \bar{V}$ (resp. $(\emptyset, \bar{F}) \in \bar{V}$) does not project well (recall Prop. 1.18), even when $\hat{\pi}$ and $\hat{\pi}$ are continuous. With this aim, a point $(P, F) \in \bar{M}$ ($P \neq \emptyset \neq F$) with no natural lift on \bar{V} will be exhibited.

Let us consider M a spacetime as described in Fig. 1.2 and V its universal cover. As it is pointed out in [35, Fig. 11], both sets P and F are S -related. Now, let us fix \bar{P} and \bar{F} lifts of the corresponding terminal sets on $\{0\} \times M \subset V$ as we have done on Example 1.45; and denote by $\{p_n\}_n \subset \{0\} \times M$ a future chronological sequence which is a lift of the sequence $\{x_n\}_n$ showed in Fig. 1.2. Recall that the lifts on V of timelike curves of M moving between S_n and S_{n+1} behave essentially as described in Example 1.45. Hence, it follows that

$$\bigcap_{n \in \mathbb{N}} I^+(p_n) = \emptyset.$$

In fact, for a given point $y \in F$ (and so, with $x_n \ll y$ for all n) with fixed lift $q \in \{0\} \times M \subset V$, there is no constant element $g \in G$ such that $(p_1 \ll) p_n \ll g q$ for all n big enough (since $p_n \ll m q_n$

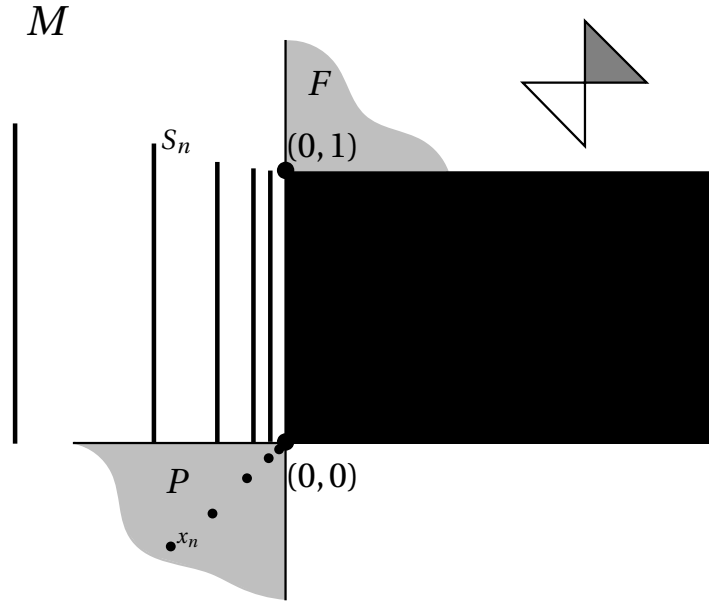

Figure 1.2: M is constructed by removing from \mathbb{L}^2 the black square and the vertical segments S_n . As it was pointed out in [35, Fig. 11], the terminal sets P and F are S -related, and so, they form a pair $(P, F) \in \overline{M}$. However, if \overline{P} is a lift of P to the universal cover V , it follows that $\uparrow \overline{P} = \emptyset$.

for $m \geq n$). This shows in particular that (V, G) is not finitely chronological (hence Thm. 1.44 (PS3) is not applicable) and that the set $\uparrow \overline{P}$ is empty, so $\overline{P} \sim_S \emptyset$.

However, it is not difficult to see that both $\hat{\pi}$ and $\check{\pi}$ are continuous. Recall that the non-continuity of such maps can only follow by the existence of a sequence $\{y_n\}_n \subset M$ admitting divergent lifts.

The only case we have to be concerned about is when $\{y_n\}_n$ converges on \mathbb{R}^2 , to the point $(0, 1)$ or to $(0, 0)$ (in the other cases, the convergence is essentially the usual one in \mathbb{R}^2). Assume for instance that the sequence $\{y_n\}_n$ converges to the point $(0, 1)$ (the other case is completely analogous). It is straightforward to check that any convergent lift with the past chronological topology of $\{y_n\}_n$ in V are, up to a subsequence, of the form $\{m \cdot q_n\}_n$, with $m \in \mathbb{Z}$ constant and $q_n \in \{0\} \times M \subset V$ a fixed lift of $\{y_n\}_n$. In particular, their limits are of the form $m \cdot \overline{F}$. This is due to the fact that the IFs involved will not have points between the segments S_n , and so, we do not have to move between different fibres of V . Therefore, any convergent lift of $\{y_n\}_n$ with the past topology converges to a terminal set on $\check{\pi}^{-1}(F)$, and so, $\{y_n\}_n$ does not have past divergent lifts (condition (ii) in Defn. 1.12 cannot be fulfilled).

For the future topology however the situation is a little more technical, as the involved IPs contain these points between the segments S_n . With some effort, it can be proved that if $\text{LI}(\{I^-(g_n q_n)\}_n) \neq \emptyset$ for some $\{g_n\}_n \subset \mathbb{Z}$, then $\text{LI}(\{I^-(g_n q_n)\}_n) = m \overline{P}$ for some $m \in \mathbb{Z}$. In particular, any convergent lift with the future topology of $\{y_n\}_n$ will converge to some TIP on $\hat{\pi}^{-1}(P)$, and so, reasoning as in the previous case, $\{y_n\}_n$ does not admit future divergent lifts.

In conclusion, M does not admit (future or past) divergent lifts, and so, both $\hat{\pi}$ and $\check{\pi}$ are continuous.

Example 1.47. (Optimality of Prop. 1.18, Cor. 1.34 and Thm. 1.44 (PS3)) Let us see: (i) sequences with divergent lifts can be obtained by a constant sequence $\{g_n\}_n$ (see Defn. 1.12 and Thm. 1.14), (ii) if a past chronological sequence has future divergent lifts, then the thesis of

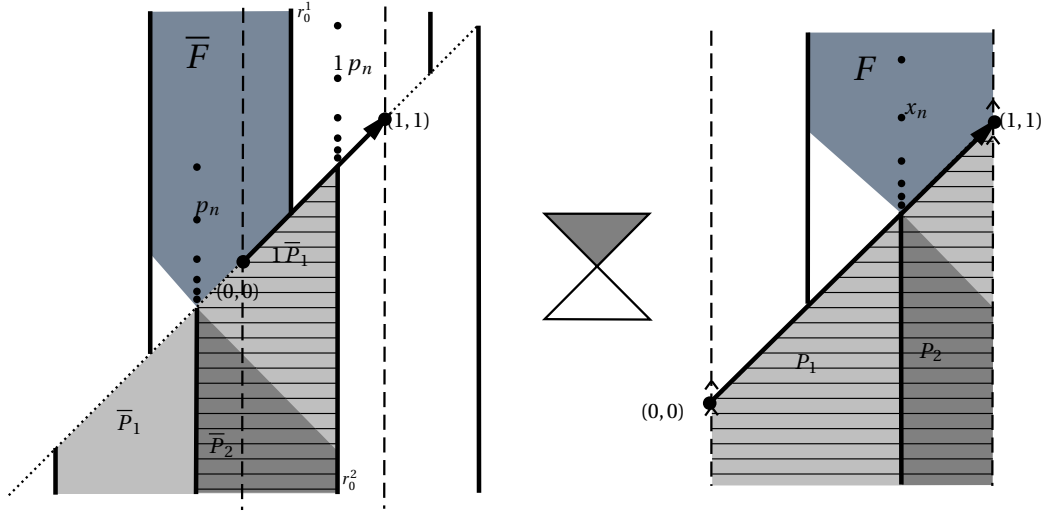

Figure 1.3: The spacetime V (on the left) is \mathbb{L}^2 with two families of lines $\{r_n^1\}_n$ and $\{r_n^2\}_n$ removed, where $r_n^1 = \{(1/3 + n, t) : t \geq 1/3 + n\}$ and $r_n^2 = \{(2/3 + n, t) : t \leq 2/3 + n\}$. The action of an element g of the group \mathbb{Z} is just a translation of g -times the vector $(1, 1)$, being the region between the striped lines in the left figure a fundamental region for the action. The quotient spacetime $M = V/\mathbb{Z}$ (on the right) is the space $(0, 1) \times \mathbb{R}$ with the points $(0, t)$ and $(1, t + 1)$ identified.

Prop. 1.18 can fail and (iii) the finite chronology property is not enough to ensure the continuity of the partial maps $\hat{\pi}$ and $\check{\pi}$, being necessary to include this hypothesis additionally, this will show the optimality of Cor.1.34.

Let us consider a spacetime $V \subset \mathbb{R}^2$ as showed in Fig. 1.3. On such a spacetime, consider $G \equiv \mathbb{Z}$ an isometry group given by the following action:

$$\begin{aligned} \mathbb{Z} \times V &\rightarrow V \\ (g, p) &\rightarrow g \cdot p := p + g(1, 1). \end{aligned}$$

The quotient $M = V/\mathbb{Z}$ can be seen as a cylinder with some cuts on it (see Fig. 1.3 (B)). Let us summarize the properties of the spacetime covering projection $\pi : V \rightarrow M$. On the one hand, and observing Fig. 1.3 (B), it follows easily that \overline{M} contains the pairs (P_1, F) and (P_2, \emptyset) . Indeed, both sets P_1, P_2 are contained in $\downarrow F$, but thanks to the identification of both lateral sides, it follows that $P_2 \subsetneq P_1$, so only P_1 is maximal on the common past of F . However, on \overline{V} we have both pairs $(\overline{P}_1, \overline{F})$ and $(\overline{P}_2, \overline{F})$, so the thesis on Prop. 1.18 is false on this case.

On the other hand, the non continuity of $\hat{\pi}$ can be deduced from the fact that $\overline{P}_2 \in \hat{L}_V(\{p_n\}_n)$ while $P_2 = \hat{\pi}(P_2) \notin \hat{L}_M(\{x_n\}_n)$, as P_1 breaks the maximality of P_2 in the superior limit. Finally, it is quite straightforward to see that (V, G) is finitely chronological. If $p \ll q$ in V , it could exist (at most) one element in $g \in \mathbb{Z}$ such that $p \ll g \cdot q$ (specifically, $g = \pm 1$). However, we cannot apply Thm. 1.44 to ensure that $\overline{\pi}$ is well defined as a map to \overline{M} as \hat{V} is not Hausdorff (recall that $\overline{P}_1, \overline{P}_2 \in \hat{L}_V(\{p_n\}_n)$).

Example 1.48. ($\overline{\pi}$ is well defined as a map to \overline{M} even when π is non tame) Let us consider the spacetime $V = \mathbb{R} \times (-1, 1) \times \mathbb{R}$ with the 3-dimensional Minkowski metric

$$g = dx^2 + dy^2 - dt^2.$$

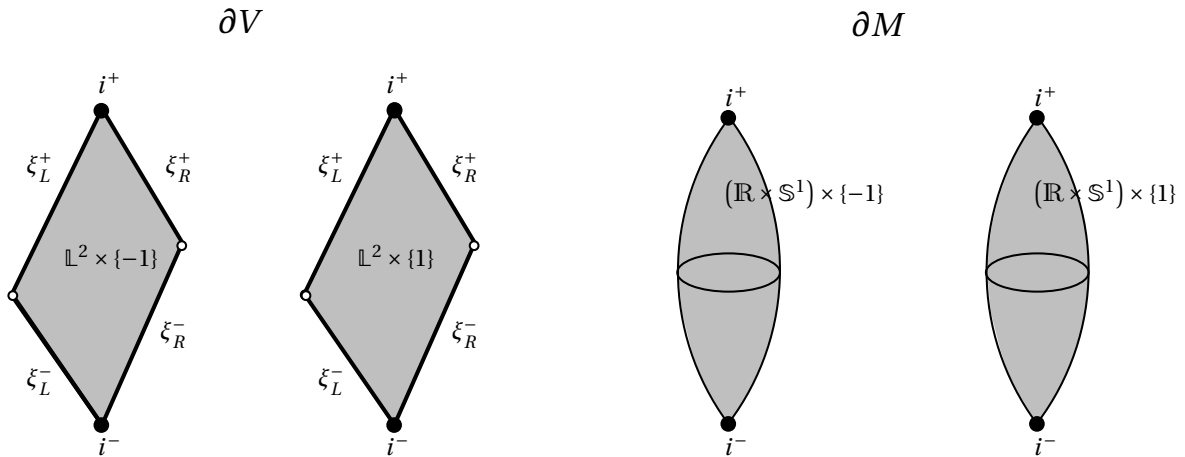

Figure 1.4: On the left figure is represented the c-boundary of V , which is formed by two copies of the c-completion of the 2-dimensional Minkowski spacetime glued by the corresponding edges (the identified edges are denoted equally). On the right figure it is represented the c-boundary of ∂M , formed by two copies of $\mathbb{R} \times \mathbb{S}^1$ and the points i^+ and i^- (again identified).

As the spacetime (V, g) is, in fact, a static spacetime, we can calculate directly its c-boundary. The structure of the c-boundary of V is given by:

$$\partial V = ((\xi_R^+ \cup \xi_L^+) \sqcup (\xi_R^- \cup \xi_L^-)) \cup (\mathbb{L}^2 \times \{-1, 1\}) \cup \{i^+, i^-\}$$

(see Fig. 1.4). Concretely, recall that the structure of the c-boundary for static models depends essentially on the so-called Busemann completion of its spatial fibre (see for instance [5, Thm. 3.10] as well as Section 1.5 for details). In this case, it follows that the associated Busemann completion for $(\mathbb{R} \times (-1, 1), dx^2 + dy^2)$ is formed by the Cauchy boundary $(\mathbb{R} \times \{-1\}) \cup (\mathbb{R} \times \{1\})$ and two additional points, each determined by inextensible curves whose x -component diverge (one point when the x -component diverges to $+\infty$ and the other to $-\infty$). The Cauchy boundary points generate in the c-boundary two copies of \mathbb{L}^2 (denoted in Fig. 1.4 by $\mathbb{L}^2 \times \{-1\}$ and $\mathbb{L}^2 \times \{1\}$) formed by timelike points, and so, with both components non empty; while the two points in the proper Busemann boundary generates four lightlike lines, two for the future and two for the past boundary, denoted by $\xi_R^+, \xi_L^+, \xi_R^-$ and ξ_L^- resp. From the topological viewpoint, and due the simplicity of the example, it follows that the chronological topology works as expected in this c-completion, being the convergence with the chronological topology the same as the usual convergence in Fig. 1.4 (after the appropriate identifications).

In the previous spacetime we define the following group action

$$\begin{aligned} \mathbb{Z} \times V &\rightarrow V \\ (z, (x, y, t)) &\rightarrow (x + z, y, t) \end{aligned}$$

so $M = V/\mathbb{Z}$ is, in fact, $M = \mathbb{S}^1 \times (-1, 1) \times \mathbb{R}$ with the induced metric. Again, the c-boundary is computable by previous methods, obtaining

$$\partial M = ((\mathbb{R} \times \mathbb{S}^1) \times \{-1, 1\}) \cup \{i^+, i^-\}$$

(here, the proper Busemann boundary is empty while the Cauchy boundary is formed by two copies of $\mathbb{R} \times \mathbb{S}^1$).

Let us describe briefly how $\bar{\pi}$ works: it takes all the lightlike points of $\hat{\partial}V$ and $\check{\partial}V$ to i^+ and i^- respectively; and it mods out by a properly discontinuous \mathbb{Z} -action on each $\mathbb{L}^2 \times \{\pm 1\}$. In

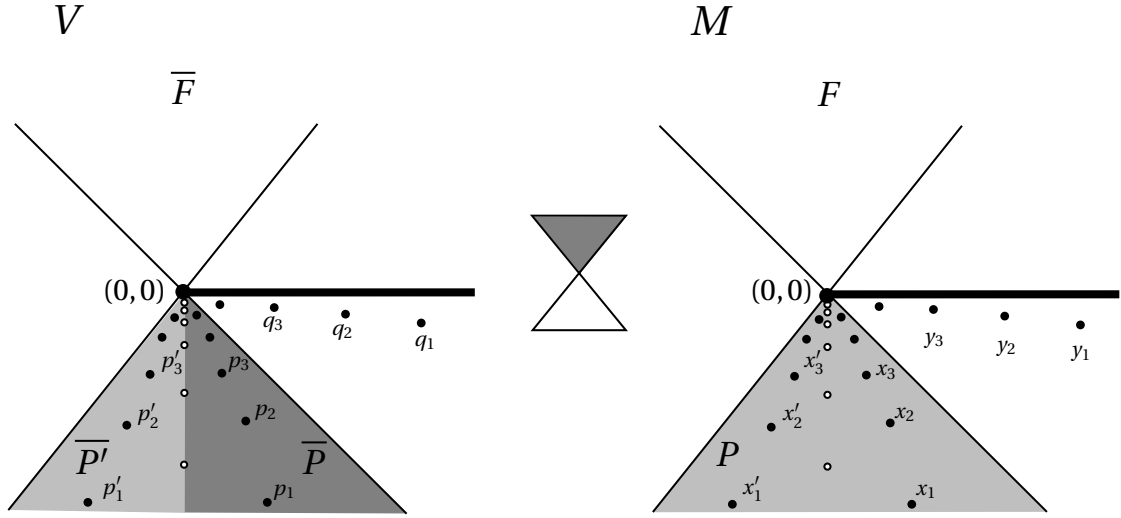

Figure 1.5: The spacetime M (on the right) is \mathbb{L}^2 with the line $r = \{(x, 0) : x \geq 0\}$ and the sequence of points $\{(0, -\frac{1}{n})\}_n$ removed, while V is the universal cover of M . On the first one, associated to the point $(0, 0)$ we have the point $(P, F) \in \partial M$. However, the set P lifts to a fixed fibre $\{0\} \times M \subset V$ as two different terminal past sets \bar{P} and \bar{P}' , creating two different points $(\bar{P}', \bar{F}), (\bar{P}, \emptyset) \in \partial V$. In particular, it follows that the sequence $\{y_n\}_n$ depicted on the right is not convergent, while its lifts $\{q_n\}_n$ converges to (\bar{P}, \emptyset) .

particular, observe that any boundary point in $(\xi_R^+ \setminus \{i^+\}) \subset \partial V$ and $i^+ \in \partial V$ are both projected to $i^+ \in \partial M$, but no element on \mathbb{Z} sends an element of the former to the latter (this can be seen as no translation in \mathbb{L}^2 sends a terminal set $\bar{P} \in \xi_R^+ \setminus \{i^+\}$ to i^+); proving that $\hat{\pi}$ is not (future) tame. In order to show that Prop. 1.23 is applicable, we have to show that any inextensible past chronological sequence on M has no future divergent lifts (being the future case completely analogous).

Let $\sigma = \{(x_n, y_n, t_n)\}_n$ be a past inextensible chronological sequence on M , and let $\bar{\sigma} = \{(x_n + z_n, y_n, t_n)\}_n$ an $\bar{\sigma}' = \{(x_n + z_n + z'_n, y_n, t_n)\}_n$ be two lifts on V . The inextensibility of σ determines two possibilities: or $\{t_n\}_n \searrow -\infty$, or $\{t_n\}_n \searrow \Omega$ and $\{y_n\}_n$ converges to some point in $\{-1, 1\}$. Observe that in the first case there is nothing to do as $\hat{L}_{chr}(\bar{\sigma}) = \hat{L}_{chr}(\bar{\sigma}') = \emptyset$. Hence we can assume that we are in the second case and, without loss of generality, that $\{y_n\}_n \rightarrow 1$. Recalling the (well) behaviour of the topology in the future completion, if $\hat{L}(\bar{\sigma}) \neq \emptyset \neq \hat{L}(\bar{\sigma}')$ then $\{(x_n + z_n, y_n, t_n)\}_n \rightarrow (x_0, 1, \Omega)$ and $\{(x_n + z_n + z'_n, y_n, t_n)\}_n \rightarrow (x'_0, 1, \Omega)$ for some $x_0, x'_0 \in \mathbb{R}$. In particular, and given that $\{x_n + z_n\}_n \rightarrow x_0$, $\{x_n + z_n + z'_n\}_n \rightarrow x'_0$ and $z'_n \in \mathbb{Z}$, we conclude that for n big enough $z'_n = z'_0$ for some fixed z'_0 . It follows then that $x'_0 = x_0 + z'_0$ and, therefore, that if $\bar{\sigma}$ and $\bar{\sigma}'$ have both limit points, such limits points are unique and project into the same point in \hat{M} . In conclusion, the sequence σ has no future divergent lifts.

Example 1.49. (Optimality of Prop.1.28, example of a non-tame projection and optimality of Prop. 1.13) In this example we will show: (i) a case of a non tame spacetime covering projection, where (and unlike Example 1.48) two terminal sets $\bar{P}, \bar{P}' \in \hat{V}$ project into the same set on \hat{M} with no element in the group G sending one to the other but with \bar{P}' S -related to a non empty set, (ii) that even if M does not admit constant sequences with future divergent lifts, the G -orbits can be non closed (showing the optimality of Prop. 1.13) and (iii) a spacetime covering projection with a sequence $\{q_n\}_n \subset V$ and a TIP $\bar{P} \in \hat{V}$ with $\bar{P} \sim_S \emptyset$ and such that $\bar{P} \in \hat{L}_V(\{I^-(q_n)\}_n)$, $P \in \hat{L}_M(\{I^-(y_n)\}_n)$ but $P \sim_S F$ with $F \neq \emptyset$ (showing the optimality of Prop. 1.28).

Let us consider the Lorentz manifold

$$M = \mathbb{L}^2 \setminus \left(\{[0, \infty) \times 0\} \cup \cup_n \left\{ \left(0, -\frac{1}{n}\right) \right\} \right)$$

(see Fig. 1.5), and take V its universal cover. The behaviour of the lifts of curves in M to V behaves essentially in the same manner described in Example 1.45, that is, it contains a numerable family of copies of M (which will be denoted again by $\{n\} \times M$) glued together accordingly; and whenever a curve $\gamma \subset M$ pass between two holes of M , the initial point and the endpoint of the lifted curve $\bar{\gamma}$ live in two different fibres of such a numerable family.

It follows that the point $(0, 0) \in \mathbb{R}^2$ has associated in \bar{M} a singular point $(P, F) \in \bar{M}$. However, the lift of the terminal set P in a concrete fibre, say $\{0\} \times M$, determines two different terminal sets \bar{P}, \bar{P}' . The reason is simple, any timelike curve joining a point of the sequence $\{x_n\}_n$ with $\{x'_n\}_n$ should pass between two holes of M , and so, its lift moves along different fibres. Moreover, from construction, we have that for each p_n there exists g_n ensuring that $p_n \in g_n \bar{P}'$. However, the sequence $\{g_n\}_n$ cannot be considered constant (not even up to a subsequence), so there is no $g \in G$ such that $\bar{P} \subset g \bar{P}'$ and the projection cannot be tame. Moreover, it follows from the construction that $\bar{P} \subset \text{LI}(\{g_n \bar{P}'\}_n)$ and it is maximal on the superior limit, i.e., $\bar{P} \in \hat{L}_V(\{g_n \bar{P}'\}_n)$. Therefore, the G -orbit $\{g \bar{P}'\}_{g \in G}$ is not closed as \bar{P} is an element not belonging to the G -orbit of \bar{P}' but which is in its closure.

Let us now show the existence of a sequence $\{q_n\}_n$ as described in the first paragraph of the example. Consider a sequence $\{y_n\}_n$ as in Fig. 1.5 and $\{q_n\}_n$ its lift in the fibre $\{0\} \times M \subset V$. As we can see in the figure, $P \in \hat{L}_M(\{I^-(y_n)\}_n)$ and $\bar{P} \in \hat{L}_V(\{I^-(q_n)\}_n)$. Moreover, as we have mention before, $P \sim_S F$ with $F \neq \emptyset$. So, it only rest to show that $\bar{P} \sim_S \emptyset$. But this follows from the fact that $\uparrow \bar{P} = \emptyset$ (recall that whenever a timelike curve moves through the space between two holes, it pass to another fibre in V). Summarizing, we have shown (in particular) that the map $\bar{\pi}$ is not continuous. The sequence $\{q_n\}_n$ converges to the point $(\bar{P}, \emptyset) \in \bar{V}$, while its projection $\{y_n\}_n$ does not converge to $(P, F) \in \bar{M}$ (note that $\text{LI}(\{I^+(y_n)\}_n) = \emptyset$).

Example 1.50. (Several candidates for the projection of a pair) The following example is a three dimensional version of the previous one. Its aim is to show three points $(\bar{P}, \emptyset), (\bar{P}', \bar{F}_1), (\bar{P}', \bar{F}_2) \in \bar{V}$ with $\hat{\pi}(\bar{P}) = \hat{\pi}(\bar{P}')$, but $\check{\pi}(\bar{F}_1) \neq \check{\pi}(\bar{F}_2)$.

Let us consider the following open set M of the three-dimensional Minkowski spacetime (with the induced metric):

$$M = \mathbb{L}^3 \setminus (C_1 \cup C_2 \cup \cup_n l_n)$$

where $C_1 = \{(x, y, t) \in \mathbb{R}^3 : y \leq 0, t \geq 0\}$, $C_2 = \{(0, y, t) \in \mathbb{R}^3 : 0 \leq t \leq 1\}$ and for $n \in \mathbb{N}$, $l_n = \{(x, 0, -1/n) : x \in \mathbb{R}\}$ (see Fig. 1.6); and consider V its universal covering.

The behaviour of the lifts/projections in this case works essentially as in previous example. In fact, if we project the figure into the plane y, z we will obtain almost the same setting as in Fig. 1.5, with the first quadrant removed (and so, sharing the same properties). Hence, the set P is naturally lifted as two different terminal sets \bar{P} and \bar{P}' living in the same fibre of V . The main difference between this case and previous example is that, even if \bar{P} is still S -related with the empty set, the set \bar{P}' is S -related with two sets, \bar{F}_1 and \bar{F}_2 corresponding to the lifts of F_1 and F_2 . Therefore, the points (\bar{P}', \bar{F}_1) and (\bar{P}', \bar{F}_2) are both \sim_{G_0} -related with the pair (\bar{P}, \emptyset) , while $\check{\pi}(\bar{F}_1) = F_1 \neq F_2 = \check{\pi}(\bar{F}_2)$.

This suggests two different possible definitions for the function α , regarding the image of the point (\bar{P}, \emptyset) . In fact, we can consider:

$$\alpha_1((\bar{P}, \emptyset)) = (\bar{P}', \bar{F}_1) \quad \text{and} \quad \alpha_2((\bar{P}, \emptyset)) = (\bar{P}', \bar{F}_2)$$

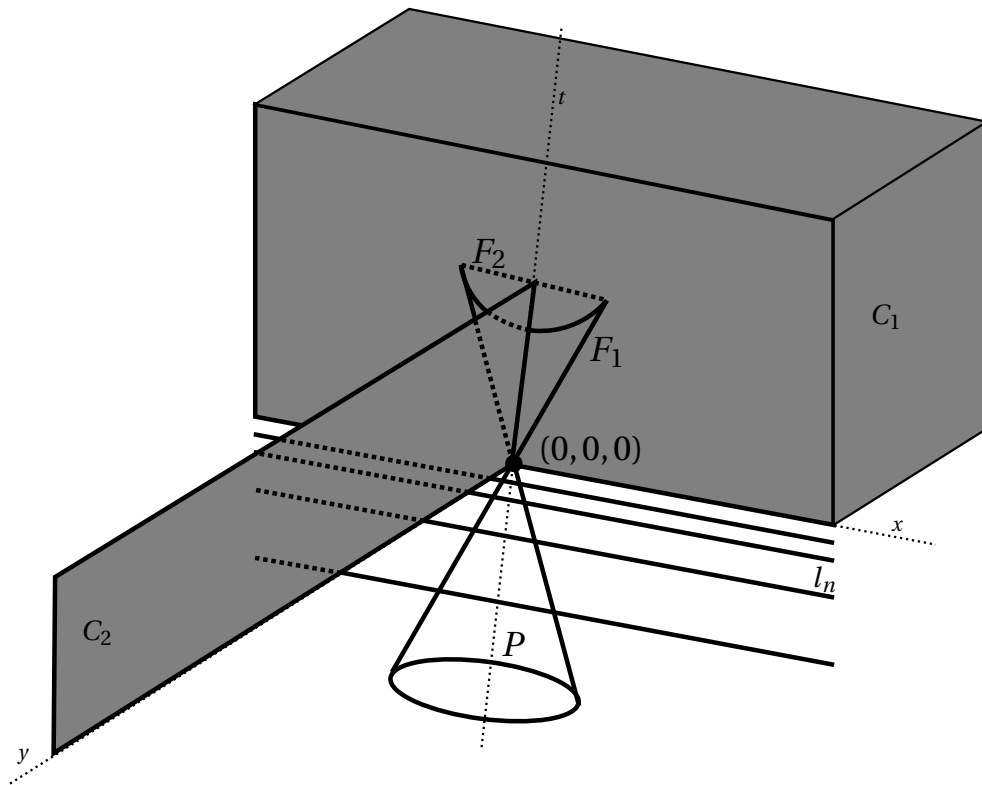

Figure 1.6: The space M is an open set of the three-dimensional Minkowski spacetime with the sets C_1 , C_2 and the sequence of lines $\{l_n\}$ removed. The point $(0,0,0)$ is represented on the c-boundary of M as two points (P, F_1) and (P, F_2) . As happen in Fig. 1.5, the lift of P to a fixed fibre of the universal cover of M give us two terminal sets \bar{P} and \bar{P}' . In particular, and recalling again that $\uparrow \bar{P} = \emptyset$, we deduce that the pairs (\bar{P}', \bar{F}_1) , (\bar{P}', \bar{F}_2) and (\bar{P}, \emptyset) belong to ∂V , the c-boundary of the universal cover of M .

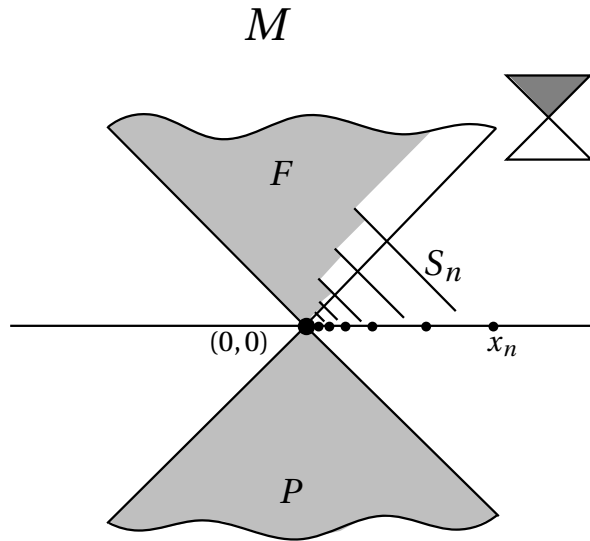

Figure 1.7: Let M be \mathbb{L}^2 with the segments S_n removed. On this example, the sets P and F are S -related and the sequence $\{x_n\}_n$ has (P, F) on its limit. However, for n big enough, the timelike curves from x_n to points in F should pass between S_n and S_{n+1} . In particular, if $\{p_n\}_n \subset \{0\} \times M$ is a lift of $\{x_n\}_n$, and \bar{F} is the corresponding lift of F in $\{0\} \times M$, then $g\bar{F} \notin \text{LI}(\{I^+(p_n)\}_n)$ for any $g \in G$.

making (\bar{P}, \emptyset) projects to (P, F_1) in the first case, or to (P, F_2) on the second one. In both cases, the corresponding extended projections share the same properties: both are well defined maps to \bar{M} , are surjective and non-continuous (as in previous example, it is possible to construct a sequence $\{q_n\}_n$ converging to the pair (\bar{P}, \emptyset) whose projection $\{y_n\}$ does not converge to either (P, F_1) nor (P, F_2)). So, as we pointed out in Rem. 1.22, there are no actual differences between $\bar{\pi}_{\alpha_1}$ and $\bar{\pi}_{\alpha_2}$ regarding the satisfied properties.

Example 1.51. (Non open \bar{j} (even when \hat{j} and \check{j} are continuous) and optimality of Prop. 1.39) Let us consider M a spacetime as in Fig. 1.7 and V the universal cover of M . On M , both sets P and F are S -related and the sequence $\{x_n\}_n$ converges to the point (P, F) . On V , and thanks that we can take curves joining points from P to F without moving between any S_n and S_{n+1} , we can obtain lifts \bar{P} and \bar{F} with $\bar{P} \sim_S \bar{F}$ (we can assume that both sets live in the fibre $\{0\} \times M$).

However, no lift of the sequence $\{x_n\}_n$ converges to (\bar{P}, \bar{F}) . In fact, let us take $\{p_n\}_n$ a fixed lift of $\{x_n\}_n$ contained in $\{0\} \times M$. It is not difficult to observe that this lift is the only one satisfying that $\bar{P} \in \hat{L}_V(\{I^-(p_n)\}_n)$. Even so, it is not true that $\bar{F} \in \check{L}_V(\{I^+(p_n)\}_n)$, as any timelike curve joining a point x_n with points on F should pass through two lines S_n , hence its lift moves between two different fibres. Therefore, the sequence $\{x_n\}_n$ has no natural convergent lift and the map \bar{j} is not open. Note that (V, G) is not finitely chronological, and this shows the optimality of Prop. 1.39.

Finally, let us observe that \hat{j} and \check{j} is continuous. This follows by reasoning as in Example 1.46, recalling that the only cases where the continuity could fail is considering sequences $\{y_n\}_n$ converging to $(0, 0)$.

Example 1.52. (\bar{V} with no lightlike boundary points while \bar{M} has them) Let

$$M = (\{(x, t) \in \mathbb{R}^2 : 0 < x < 1, -1 < t \leq x\} \cup ((1, 2) \times (-1, 1))) \setminus \cup_n S_n$$

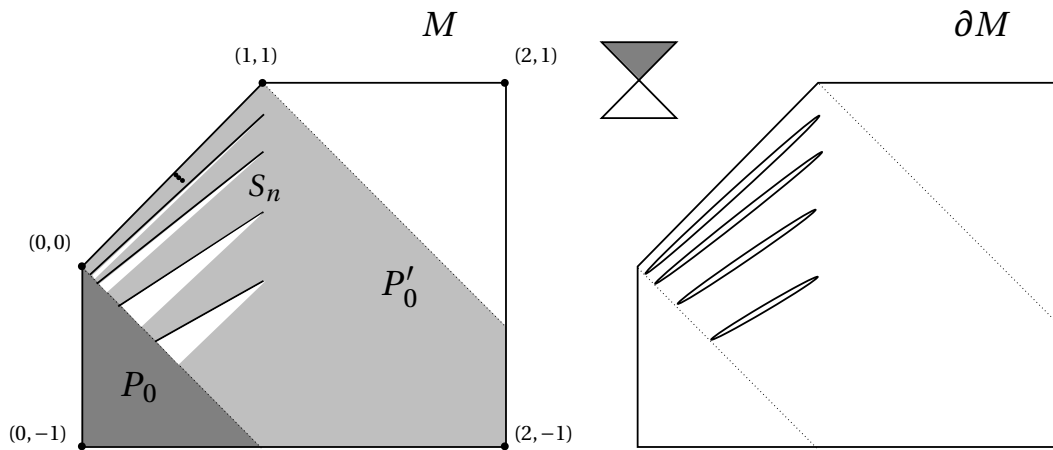

Figure 1.8: Let M be an open set of \mathbb{L}^2 with the segments S_n removed as in the left of the figure. Even if the segments are spacelike, the terminal set P'_0 (the past of the boundary point $(1, 1)$) contains P_0 (the past of $(0, 0)$).

The c -boundary of M is represented on the right of the figure. Observe that, in the c -boundary, each segment S_n is represented by a thin ellipse. This is due the fact that any non-extremal point of the segment is reachable by a future and past inextensible timelike curve, but the corresponding terminal sets are not S -related. So, such points are represented in the c -boundary as two points of the form (P, \emptyset) and (\emptyset, F) . Only on the extremal points the corresponding TIP and TIF are S -related, and so, they determine only one point in the c -boundary.

be a manifold as in Fig. 1.8 endowed with the induced Minkowski metric, where each S_n is a spacelike segment obtained from a small variation of the lightlike segment joining $(1/n, -1/n)$ and $(1, 1 - 2/n)$. Due the fact that $(1/n, -1/n) \ll (1, 1 - 2/(n+1))$, such a variation can be taken in such a way that the past of the upper-right extreme of S_{n+1} contains the down-left extreme of S_n . Let V be the universal cover of M .

The c-boundary (and so, the c-completion) of M is represented on the right of Fig. 1.8 and it is formed almost entirely by spatial and timelike boundary points. However, the points $(0, 0)$ and $(1, 1)$ are represented on the boundary by pairs of the form (P_0, \emptyset) and (P'_0, \emptyset) with $P_0 \subsetneq P'_0$ ⁴, hence \overline{M} has lightlike boundary points. Topologically the c-completion \overline{M} is Hausdorff, as it has the induced topology from \mathbb{R}^2 .

Now, if we look into the lifts of boundary points from \overline{M} to \overline{V} , we observe that timelike and spatial boundary points are lifted to timelike and spatial boundary points respectively. However, there exist no lifts $(\overline{P}_0, \emptyset)$ and $(\overline{P}'_0, \emptyset)$ of (P_0, \emptyset) and (P'_0, \emptyset) resp. such that $\overline{P}_0 \subsetneq \overline{P}'_0$, as any timelike curve moving from a point close to $(1, 1)$ to a point close to $(0, 0)$ should move between two segments S_m and S_{m+1} , and so, it will move between different fibres of V (recall again the behaviour of the universal covering described on Example 1.45). Therefore, \overline{V} will have no lightlike boundary points. Finally, and due the fact that the topology around a point of \overline{V} coincides again with the induced topology from \mathbb{R}^2 , we have that \overline{V} is also Hausdorff.

1.5 A physical application: Quotients on Robertson-Walker Spacetimes

As a final section of this chapter, we will show how our results are applicable to concrete and physically relevant models of spacetimes. Our main aim will be to apply Corollaries 1.41 and 1.43 where, in addition to the finite chronology, we need Hausdorffness on both \hat{V} and \check{V} and the non existence of lightlike boundary points on \overline{M} (recall also Cor. 1.42).

We will focus on the case of Robertson Walker models, even if our results are extensible to other more general ones (see Rem. 1.56). The c-completion of such a models is well known [5, Section 4.2], but we include the details in here for completeness. Observe that we are not going to follow the original approach proposed in [5], but the approach introduced in [36, Section 3].

Let (Σ, h_Σ) be a Riemannian manifold. Denote by $t : \mathbb{R} \times \Sigma \rightarrow \mathbb{R}$ and $\pi_\Sigma : \mathbb{R} \times \Sigma \rightarrow \Sigma$ the corresponding projections; and consider a smooth positive function $\alpha : \mathbb{R} \rightarrow (0, \infty)$. A Robertson Walker model with base Σ and warping function α is given by the pair (V, g) , where

$$V = \mathbb{R} \times \Sigma, \quad \text{and} \quad g = -dt^2 + (\alpha \circ t) \pi_\Sigma^*(h_\Sigma). \quad (1.12)$$

For simplicity, $\alpha \circ t$ will be denoted just by $\alpha(t)$ and, whenever there is no confusion, we will omit the pullback π_Σ^* . The chronological relation on these models is characterized as (see [36, Prop. 3.1]):

$$(t_0, x_0) \ll (t_1, x_1) \iff d(x_0, x_1) < \int_{t_0}^{t_1} \frac{1}{\sqrt{\alpha(s)}} ds$$

where d denotes the distance on Σ defined by h_Σ . Thanks to the previous characterization of the chronological relation, it follows that any future terminal set P is determined by the so-called Busemann functions. Such functions are defined in the following way: given a curve $c : [a, \Omega) \rightarrow \Sigma$ satisfying that $h_\Sigma(\dot{c}, \dot{c}) < 1$, we define the associated Busemann function as:

⁴Observe that $(1/n, -1/n) \ll (1, 1 - 2/(n+1))$, so it is possible to obtain timelike curves passing between S_n and S_{n+1} .

$$b_c(\cdot) = \lim_{t \rightarrow \Omega} \left(\int_0^t \frac{1}{\sqrt{\alpha(s)}} ds - d(\cdot, c(t)) \right)$$

Then, for any indecomposable past set P , it follows that $P = P(b_c)$ for some curve c with $h_\Sigma(\dot{c}, \dot{c}) < 1$, where

$$P(b_c) = \left\{ (t, x) \in V : \int_0^t \frac{1}{\sqrt{\alpha(s)}} ds < b_c(x) \right\}$$

(see [36, Equation (3.3)]). If we have either $\Omega < \infty$; or $\Omega = \infty$ and $\int_0^\infty \frac{1}{\sqrt{\alpha(s)}} ds < \infty$; it follows that $c(t) \rightarrow x^* \in \Sigma_C$, where Σ_C denotes the Cauchy completion associated to (Σ, h_Σ) . Moreover, $b_c(\cdot) = d_{(\Omega, x^*)}(\cdot) := \int_0^\Omega \frac{1}{\sqrt{\alpha(s)}} ds - d(\cdot, x^*)$ (see [36, Equations (3.7) and (3.8)]). In this way, and under the assumption of previous integral condition, we have that the future causal completion has the following point set structure:

$$\hat{V} \equiv \Sigma_C \times \{\mathbb{R} \cup \{\infty\}\}$$

The study is completely analogous for the past orientation, where if we assume the integral condition $\int_{-\infty}^0 \frac{1}{\sqrt{\alpha(s)}} ds < \infty$, the past causal completion is identified with:

$$\check{V} \equiv \Sigma_C \times \{\mathbb{R} \cup \{-\infty\}\}.$$

Finally, for the (total) c -completion, we only need to observe that past and future indecomposable past sets are S -related if they are associated to the same pair $(\Omega, x^*) \in \mathbb{R} \times \Sigma_C$ (see [36, Equation (3.14)] and the paragraph above). In conclusion, the following result follows:

Proposition 1.53. *Let (V, g) be a Robertson Walker model as in (1.12), and assume the following integral conditions*

$$\int_0^\infty \frac{1}{\sqrt{\alpha(s)}} ds < \infty, \quad \int_{-\infty}^0 \frac{1}{\sqrt{\alpha(s)}} ds < \infty. \quad (1.13)$$

Then, the c -completion, as point set, becomes

$$\bar{V} \equiv \Sigma_C \times \{\{-\infty\} \cup \mathbb{R} \cup \{\infty\}\}.$$

Chronologically, the c -boundary has two copies, one for the future and one for the past, of the Cauchy completion Σ_C formed by spatial boundary points; and timelike lines over each point of the Cauchy boundary of Σ . Topologically, and assuming that Σ_C is locally compact, the chronological topology on \bar{V} coincides with the product topology in $\Sigma_C \times \{\{-\infty\} \cup \mathbb{R} \cup \{\infty\}\}$. Moreover, both \hat{V} and \check{V} are Hausdorff.

Proof. The pointset and causal structure can be deduced from previous comments (see also [5, Thm. 4.2]). For the topological structure, we only need to recall that [37, Prop. 5.24] is also applicable to this approach and, moreover, it is also true when $\Omega = \infty$ if the integral condition holds. \square

Therefore, when the integral conditions are satisfied and the associated Cauchy completion Σ_C is locally compact, both \hat{V} and \check{V} are Hausdorff and \bar{V} has no lightlike boundary points. Therefore, and as a consequence of Cor. 1.43:

Theorem 1.54. *Let (V, g) be a Robertson Walker model as in (1.12) and assume both, the integral conditions in (1.13) and that Σ_C is locally compact. Then, if $\pi : V \rightarrow M$ is a spacetime covering projection with associated group G , (V, G) is finitely chronological and the G -orbits are closed for both \hat{V} and \check{V} , then \bar{V}/G and \bar{M} are both, chronologically isomorphic and homeomorphic.*

Obviously, our results are applicable in other Robertson Walker models without the integral conditions (1.13). For instance, the Anti-de Sitter model also satisfy both, it has Hausdorff partial completions and has no lightlike boundary points (see [5, Section 4.1]). Moreover, the only pairs in \overline{V} with an empty component are of the form (V, \emptyset) and (\emptyset, V) , corresponding to i^+ and i^- , so it follows readily that \overline{M} has no lightlike boundary points. Hence:

Theorem 1.55. *Let (V, \mathfrak{g}) be the Anti-de Sitter model with a timelike line for the origin removed, that is, $V = \mathbb{R} \times (0, \infty) \times \mathbb{S}^2$ and*

$$g = -\cosh^2(r)dt^2 + dr^2 + \sinh^2(r)(d\theta^2 + \sin^2\theta d\phi^2).$$

Assume that we have a spacetime covering projection $\pi : V \rightarrow M$ with associated group G and such that (V, G) is finitely chronological. Then, $\overline{V}/G \equiv \overline{M}$.

The previous result can be used, for instance, to calculate the c-completion of the BTZ blackhole models [8] and the Hawking-Page reference model [62], which are obtained as suitable quotients of the 3-dimensional Anti-de Sitter model [7, 103, 104].

Remark 1.56. We would like to note that Thm. 1.54 is generalizable to other, more general, models of spacetimes. For instance, a similar result follows for Lorentz manifolds $(\mathbb{R} \times \Sigma, \mathfrak{g})$ with

$$g = -dt^2 + \sqrt{\alpha \circ t} \pi_{\Sigma}^*(\omega) \otimes dt + \sqrt{\alpha \circ t} dt \otimes \pi_{\Sigma}^*(\omega) + (\alpha \circ t) \pi_{\Sigma}^*(h_{\Sigma}) \quad (1.14)$$

where ω is a one-form of Σ . Observe that such metrics are generalizations of Robertson-Walker models to the standard stationary settings. In fact, the theory developed in [37] for the stationary case is enough to study their c-completion (see [36, Section 3]).

The c-completion of the standard stationary case presents remarkable differences with respect to the Static one, mainly because its causality is no longer determined by a (regular) distance but by a (non-symmetric) generalized distance. That lack of symmetry is reflected on different structures for the future and past c-completions. For instance, future and past completions depends on different Cauchy completions (named by forward and backward Cauchy completions and denoted by Σ_C^{\pm} resp., see [37, Section 6]). However, an under some mild hypotheses (the local compactness of Σ_C^{\pm} and the well behaviour of the extended distance to such spaces, see [37, Thm. 1.2]), we can obtain analogous versions of Prop. 1.53 and Thm. 1.54 for the model (1.14).

Causality and c-completion of multiwarped spacetimes

In this chapter a systematic study of the causal structure, the global causality properties and the causal completion of multiwarped spacetimes is developed. In section 2.1, we study the characterizations of the chronological and causal relations in these spacetimes, and, its position in the causal hierarchy. In sections 2.2 and 2.3, we study the future causal completion of these spacetimes, focusing first in the Generalized Robertson Walker spacetime in order to get some intuition of the structure of the future causal completion in the warped case, and, then we proceed to the study of future c-completion for doubly warped spacetimes (analogously for the past completion, see 2.4). In section 2.5, the total causal completion of doubly warped spacetimes is studied. Finally, in section 2.7 we compute the c-completion of some physical relevant spacetimes, such as, Kasner models, the intermediate part of Reissner Nodström spacetime, the interior part of Schwarzschild spacetime and warped products of De Sitter spacetime with (not necessarily compact) Riemannian manifolds.

2.1 The causal structure of doubly warped spacetimes

A *multiwarped spacetime* (V, \mathbf{g}) can be written as $V = (a, b) \times M_1 \times \cdots \times M_n$, $-\infty \leq a < b \leq \infty$, and

$$\mathbf{g} = -dt^2 + \alpha_1 h_1 + \cdots + \alpha_n h_n, \quad (2.1)$$

where $\alpha_i : (a, b) \rightarrow \mathbb{R}$ are positive smooth functions and (M_i, h_i) are Riemannian manifolds, for all $i = 1, \dots, n$.

In order to simplify the notation, we will work with *doubly warped spacetimes*, i.e. , a multiwarped spacetime (V, \mathbf{g}) as in (2.1) with two fibers ($n = 2$), that is,

$$V := (a, b) \times M_1 \times M_2 \quad \text{and} \quad \mathbf{g} = -dt^2 + \alpha_1 h_1 + \alpha_2 h_2. \quad (2.2)$$

It is worth to mention that all the results that we will obtain for doubly warped spacetimes are also true in the general case, see Section 2.6.

Now, let us start with the main purpose in this section: the characterization of the chronological and causal relations in doubly warped spacetimes.

Take $(t^e, x^e) \in V$ and $x^o \in M := M_1 \times M_2^1$. Denote by $C(x^o, x^e)$ the set of smooth curves in M connecting x^o with x^e . Given $c = (c_1, c_2) \in C(x^o, x^e)$, consider the unique future-directed light-like curve $\rho : [s^o, s^e] \rightarrow V$ with $\rho(s) = (\tau_{c,t^e}(s), c(s))$ and $\tau_{c,t^e}(s^e) = t^e$. From the metric expression in (2.2), the component $\tau_{c,t^e}(s)$ is determined by the Cauchy problem

$$-\dot{\tau}_{c,t^e}^2 + \alpha_1(\tau_{c,t^e})h_1(\dot{c}_1, \dot{c}_1) + \alpha_2(\tau_{c,t^e})h_2(\dot{c}_2, \dot{c}_2) = 0, \quad \tau_{c,t^e}(s^e) = t^e.$$

Consider the functional

$$\mathcal{J}_{x^o, (t^e, x^e)} : C(x^o, x^e) \rightarrow [a, b], \quad c \mapsto \begin{cases} \tau_{c,t^e}(s^o) & \text{if } \tau_{c,t^e} \text{ defined on } [s^o, s^e] \\ a & \text{otherwise.} \end{cases}$$

By using the transitivity of the chronological and causal relation [83, Corollary 14.01], it follows that $(t^o, x^o) \ll (t^e, x^e)$ if, and only if, there exists $c \in C(x^o, x^e)$ such that $t_o < \mathcal{J}_{x^o, (t^e, x^e)}(c)$. This property suggests the following definition for the *departure time function*:

$$T : M \times ((a, b) \times M) \rightarrow [a, b], \quad T(x^o, (t^e, x^e)) := \text{Sup}_{C(x^o, x^e)} \mathcal{J}_{x^o, (t^e, x^e)}$$

(compare with [85, Section 2.9] and [41, Section 4]). By construction, this function characterizes the chronological relation in (V, \mathfrak{g}) , as follows:

$$(t^o, x^o) \ll (t^e, x^e) \iff t^o < T(x^o, (t^e, x^e)). \quad (2.3)$$

In particular, the chronological past of a given point (t^e, x^e) is given by

$$I^-((t^e, x^e)) := \{(t, x) \in (a, b) \times M : t < T(x, (t^e, x^e))\}.$$

Given a future-directed timelike curve $\gamma(t) = (t, c(t))$, $t \in [\omega, \Omega)$, and a point $x \in M$, the transitivity of the chronological relation \ll ensures that the function $T(x, \gamma(t))$ is increasing on t . Hence, the chronological past of γ can be written as

$$I^-(\gamma) = \{(s, x) \in (a, b) \times M : s < b_c(x) := \lim_{t \rightarrow b} T(x, \gamma(t))\}.$$

Next, let us characterize the departure time function, and so, the chronological relations (recall (2.3)), in terms of some integral conditions involving the warping functions α_i and the Riemannian distances d_i associated to the fibers (M_i, g_i) , $i = 1, 2$. To this aim, let us consider a future-directed causal curve $\gamma : I \rightarrow V$, $\gamma(s) = (t(s), c_1(s), c_2(s))$. From the metric expression in (2.2):

$$\frac{dt}{ds}(s) = \sqrt{-D + \frac{\mu_1}{\alpha_1 \circ t} + \frac{\mu_2}{\alpha_2 \circ t}}(s),$$

where $D := g(d\gamma/ds, d\gamma/ds) \leq 0$ and $\mu_i := (\alpha_i \circ t)^2 h_i(dc_i/ds, dc_i/ds)$, $i = 1, 2$. From the Inverse Function Theorem, previous formula translates into

$$\frac{ds}{dt}(t) = \left(-(D \circ s) + \frac{\mu_1 \circ s}{\alpha_1} + \frac{\mu_2 \circ s}{\alpha_2} \right)^{-1/2}.$$

Therefore, if we denote $t^o = t(s^o)$, $t^e = t(s^e)$, we deduce

$$\begin{aligned} \text{length}(c_i |_{[s^o, s^e]}) &= \int_{s^o}^{s^e} \sqrt{h_i(\dot{c}_i, \dot{c}_i)} ds = \int_{t^o}^{t^e} \sqrt{h_i(\dot{c}_i, \dot{c}_i)} \frac{ds}{dt} dt \\ &= \int_{t^o}^{t^e} \frac{\sqrt{\mu_i \circ s}}{\alpha_i(t)} \left(-(D \circ s) + \frac{\mu_1 \circ s}{\alpha_1} + \frac{\mu_2 \circ s}{\alpha_2} \right)^{-1/2} dt \quad \text{for } i = 1, 2. \end{aligned} \quad (2.4)$$

In the particular case of being γ a lightlike geodesic we have: (i) $D = 0$ (lightlike character of γ), (ii) $\mu_i \circ s$ are constants and (iii) c_i are (pre-)geodesics on the corresponding Riemannian manifold (M_i, g_i) (geodesic character of γ). So, from (2.4), one deduces (see [40, Thm. 2] for details):

¹Along the chapter, superscripts “o” and “e” concern to “origin” and “end”, respectively.

Proposition 2.1. *Let (V, g) be a doubly warped spacetime as in (2.2) with (weakly) convex fibers (i.e., satisfying that any pair of points can be joined by some minimizing geodesic). Consider two distinct points $(t^o, x_1^o, x_2^o), (t^e, x_1^e, x_2^e) \in V$ with $t^o < t^e$. Then, the following statements are equivalent:*

- (a) *There exists a lightlike geodesic joining (t^o, x_1^o, x_2^o) and (t^e, x_1^e, x_2^e) .*
- (b) *There exist $\mu_1, \mu_2 \geq 0$ with $\mu_1 + \mu_2 = 1^2$ such that*

$$\int_{t^o}^{t^e} \frac{\sqrt{\mu_i}}{\alpha_i(s)} \left(\sum_{k=1}^2 \frac{\mu_k}{\alpha_k(s)} \right)^{-1/2} ds = d_i(x_i^o, x_i^e) \quad \text{for } i = 1, 2;$$

We are now in conditions to establish the characterization of the chronological relation.

Proposition 2.2. *Let (V, g) be a doubly warped spacetime as in (2.2), and $(t^o, x^o), (t^e, x^e) \in V$ with $x^o \neq x^e$. The following conditions are equivalent:*

- (i) *$(t^o, x^o) \ll (t^e, x^e)$; or, equivalently, $t^o < T(x^o, (t^e, x^e))$ (recall (2.3));*
- (ii) *$T(x^o, (t^e, x^e))$ is the unique real value $T \in (a, b)$ with $t^o < T < t^e$ such that, for some (unique) positive constants $\mu_1, \mu_2 \geq 0$, with $\mu_1 + \mu_2 = 1$, it satisfies*

$$\int_T^{t^e} \frac{\sqrt{\mu_i}}{\alpha_i(s)} \left(\sum_{k=1}^2 \frac{\mu_k}{\alpha_k(s)} \right)^{-1/2} ds = d_i(x_i^o, x_i^e) \quad \text{for } i = 1, 2; \quad (2.5)$$

- (iii) *there exist strictly positive constants $\mu'_1, \mu'_2 > 0$, with $\mu'_1 + \mu'_2 = 1$, such that*

$$\int_{t^o}^{t^e} \frac{\sqrt{\mu'_i}}{\alpha_i(s)} \left(\sum_{k=1}^2 \frac{\mu'_k}{\alpha_k(s)} \right)^{-1/2} ds > d_i(x_i^o, x_i^e) \quad \text{for } i = 1, 2. \quad (2.6)$$

Proof. The implication (ii) \Rightarrow (iii) is trivial unless some μ_i is equal to 0. So, assume for instance that $\mu_1 = 0$ (and so, $\mu_2 = 1$). Then, (2.5) becomes

$$\begin{cases} 0 = d_1(x_1^o, x_1^e) \\ \int_T^{t^e} \frac{1}{\sqrt{\alpha_2(s)}} ds = d_2(x_2^o, x_2^e). \end{cases}$$

By continuity, we can modify slightly μ_1, μ_2 , to obtain strictly positive μ'_1, μ'_2 , with $\mu'_1 + \mu'_2 = 1$, such that

$$\begin{cases} \int_{t^o}^{t^e} \frac{\sqrt{\mu'_1}}{\alpha_1(s)} \left(\sum_{k=1}^2 \frac{\mu'_k}{\alpha_k(s)} \right)^{-1/2} ds > 0 = d_1(x_1^o, x_1^e) \\ \int_{t^o}^{t^e} \frac{\sqrt{\mu'_2}}{\alpha_2(s)} \left(\sum_{k=1}^2 \frac{\mu'_k}{\alpha_k(s)} \right)^{-1/2} ds > d_2(x_2^o, x_2^e), \end{cases}$$

as desired.

²Note that only the relative weight between the “velocities” of the spatial pregeodesics is relevant to find the right initial direction to connect geodesically the given points, so, this condition ‘fixes the extra gauge’.

For the implication $(iii) \Rightarrow (i)$, denote

$$L_i^\epsilon := \int_{t^o+\epsilon}^{t^e} \frac{\sqrt{\mu'_i}}{\alpha_i(s)} \left(\sum_{k=1}^2 \frac{\mu'_k}{\alpha_k(s)} \right)^{-1/2} ds, \quad \text{for } \epsilon > 0.$$

Take $\epsilon > 0$ small enough so that $t^o + \epsilon < t^e$ and the inequalities in (2.6) still hold for $t^o + \epsilon$ instead of t^o . Since $L_i^\epsilon > d_i(x_i^o, x_i^e)$, there exist curves $y_i : [s^o, s^e] \rightarrow M_i$, with $y_i(s^o) = x_i^o$ and $y_i(s^e) = x_i^e$, such that $\text{length}(y_i) = L_i^\epsilon$, $i = 1, 2$. Consider the lightlike curve $\rho(s) = (\tau(s), \bar{y}_1(s), \bar{y}_2(s))$, with \bar{y}_i reparametrizations of y_i , constructed by requiring

$$\begin{cases} \dot{\tau} = \sqrt{\sum_{i=1}^2 \frac{\mu'_i}{\alpha_i \circ \tau}} & , & \begin{cases} h_i(\dot{\bar{y}}_i, \dot{\bar{y}}_i) = \frac{\mu'_i}{(\alpha_i \circ \tau)^2} \\ \bar{y}_i(s^e) = x_i^e \end{cases} \end{cases} \quad \text{for } i = 1, 2.$$

If τ remains above $t^o + \epsilon$ then there exists $t^1 > t^o$ such that ρ connects (t^1, x^o) to (t^e, x^e) and so $(t^o, x^o) \ll (t^e, x^e)$. Otherwise, by applying (2.4) to the lightlike curve ρ (in particular, $D = 0$), we deduce

$$\text{length}(\bar{y}_i |_{[t^{-1}(t^o+\epsilon), s^e]}) = \int_{t^o+\epsilon}^{t^e} \frac{\sqrt{\mu'_i}}{\alpha_i(s)} \left(\sum_{k=1}^2 \frac{\mu'_k}{\alpha_k(s)} \right)^{-1/2} ds = L_i^\epsilon = \text{length}(y_i).$$

Therefore, $\rho(s)$ is a lightlike curve joining $(t^o + \epsilon, x^o)$ with (t^e, x^e) , and so, these points are causally related. Since $(t^o, x^o) \ll (t^o + \epsilon, x^o)$, necessarily $(t^o, x^o) \ll (t^e, x^e)$.

Finally, for the implication $(i) \Rightarrow (ii)$, let us show first that if T satisfies (2.5) then $T \leq T(x^o, (t^e, x^e))$. So, assume that (2.5) holds. Take any sequence $\epsilon_m \searrow 0$ and define

$$L_{i,m} := \int_{T-\epsilon_m}^{t^e} \frac{\sqrt{\mu_i}}{\alpha_i(s)} \left(\sum_{k=1}^2 \frac{\mu_k}{\alpha_k(s)} \right)^{-1/2} ds \quad i=1,2.$$

We have that $L_{i,m} > d_i(x_i^o, x_i^e)$ for all i . The implication $(iii) \Rightarrow (i)$, which has been proved before, ensures that $(T - \epsilon_m, x^o) \ll (t^e, x^e)$ for all m . Therefore, from the definition of $T(x^o, (t^e, x^e))$, $T - \epsilon_m < T(x^o, (t^e, x^e))$ for all m , and then, $T \leq T(x^o, (t^e, x^e))$.

Next, it is sufficient to prove that some value T verifying (2.5) always exists, and necessarily $T \geq T(x^o, (t^e, x^e))$. Let $t' < T(x^o, (t^e, x^e))$, and thus, $(t', x^o) \ll (t^e, x^e)$. Let $\gamma : [t', t^e] \rightarrow V$, $\gamma(t) = (t, c_1(t), c_2(t))$, be a timelike curve such that $\gamma(t') = (t', x^o)$ and $\gamma(t^e) = (t^e, x^e)$. Consider real curves \bar{c}_i , $i = 1, 2$, such that

$$\begin{cases} 0 \leq \dot{\bar{c}}_i(t) \leq \sqrt{h_i(\dot{c}_i(t), \dot{c}_i(t))} \\ \bar{c}_i(t') = 0 \\ \bar{c}_i(t^e) = d_i(x_i^o, x_i^e) \end{cases} \quad \text{for } i = 1, 2.$$

Then, $\bar{\gamma}(t) = (t, \bar{c}_1(t), \bar{c}_2(t))$ becomes a future directed timelike curve in the globally hyperbolic doubly warped spacetime with convex fibers $V' = ((a, b) \times \mathbb{R}^2, -dt^2 + \alpha_1 dx_1^2 + \alpha_2 dx_2^2)$ (recall [11, Thm. 3.68]) joining $\bar{\gamma}(t') = (t', 0, 0)$ with $\bar{\gamma}(t^e) = (t^e, d_1(x_1^o, x_1^e), d_2(x_2^o, x_2^e))$, i.e.,

$$\bar{\gamma}(t') = (t', 0, 0) \ll (t^e, d_1(x_1^o, x_1^e), d_2(x_2^o, x_2^e)) = \bar{\gamma}(t^e).$$

Consider $T > t'$ such that $(T, 0, 0) \leq \bar{\gamma}(t^e)$ but $(T, 0, 0) \not\ll \bar{\gamma}(t^e)$. From Avez and Seifert's result, there exists some lightlike geodesic in V' joining both points. Now, from Prop. 2.1 applied to this lightlike geodesic, there exist unique positive constants $\mu_1, \mu_2 \geq 0$, with $\mu_1 + \mu_2 = 1$, such that

$$\int_T^{t^e} \frac{\sqrt{\mu_i}}{\alpha_i(s)} \left(\sum_{k=1}^2 \frac{\mu_k}{\alpha_k(s)} \right)^{-1/2} ds = |d_i(x_i^o, x_i^e) - 0| = d_i(x_i^o, x_i^e) \quad \text{for } i = 1, 2.$$

Finally, since $t' < T$ for all $t' < T(x^o, (t^e, x^e))$, necessarily $T(x^o, (t^e, x^e)) \leq T$, which concludes the proof. \square

Let us consider now the characterization of the causal relation (see [40, Thm. 2(2)]).

Definition 2.3. A Riemannian manifold (N, h) is L -convex if any pair of points $p, q \in N$ with $d_h(p, q) < L$ can be joined by a minimizing geodesic.

Proposition 2.4. Let (V, g) be a doubly warped spacetime as in (2.2) whose fibers (M_i, g_i) are L_i -convex for $i = 1, 2$. Consider two points $(t^o, x_1^o, x_2^o), (t^e, x_1^e, x_2^e) \in V$, with $t^o \leq t^e$, satisfying $d(x_i^o, x_i^e) < L_i$, $i = 1, 2$. Then, the following conditions are equivalent:

- (i) the points are causally related, $(t^o, x_1^o, x_2^o) \leq (t^e, x_1^e, x_2^e)$;
- (ii) there exists a causal geodesic joining (t^o, x_1^o, x_2^o) with (t^e, x_1^e, x_2^e) ;
- (iii) there exist constants $\mu'_1, \mu'_2 \geq 0$, $\mu'_1 + \mu'_2 = 1$, such that

$$\int_{t^o}^{t^e} \frac{\sqrt{\mu'_i}}{\alpha_i(s)} \left(\sum_{k=1}^2 \frac{\mu'_k}{\alpha_k(s)} \right)^{-1/2} ds \geq d_i(x_i^o, x_i^e) \quad \text{for } i = 1, 2. \quad (2.7)$$

Moreover, if the equalities hold in (2.7), then there is a lightlike and no timelike geodesic joining the points.

2.1.1 Position into the causal ladder

In order to have an idea of the goodness of the causality of doubly warped spacetimes, next we are going to determine their position into the causal ladder. As we will see, this depends on the warping functions integrals and the convexity character of their Riemannian fibers. It is direct from the very basic structure of doubly warped spacetimes (2.2) that $t : V \rightarrow (a, b)$ is a global time function (see [11, Lemma 3.55]). Therefore, any doubly warped spacetime is stably causal, see Def. 9 (vi). The approach developed in previous section will allow to show that any doubly warped spacetime is causally continuous as well. In fact:

Theorem 2.5. Any doubly warped spacetime (V, g) as in (2.2) is causally continuous.

Proof. Since (V, g) is stably causal, then it is also distinguishing. So, it suffices to show that (V, g) is reflecting. Let $(t^o, x_1^o, x_2^o), (t^e, x_1^e, x_2^e) \in V$ be such that $I^+((t^e, x_1^e, x_2^e)) \subset I^+((t^o, x_1^o, x_2^o))$, and let us prove that $I^-((t^o, x_1^o, x_2^o)) \subset I^-((t^e, x_1^e, x_2^e))$ (the converse is analogous). Consider the sequence $\{(t^e + 1/n, x_1^e, x_2^e)\}_n \subset I^+((t^e, x_1^e, x_2^e))$ and note that, by the hypothesis, this sequence also belongs to $I^+((t^o, x_1^o, x_2^o))$. Therefore, from Prop. 2.2, there exist constants $\mu_1^n, \mu_2^n > 0$, with $\mu_1^n + \mu_2^n = 1$, satisfying the following inequalities:

$$\int_{t^o}^{t^e + 1/n} \frac{\sqrt{\mu_i^n}}{\alpha_i(s)} \left(\sum_{k=1}^2 \frac{\mu_k^n}{\alpha_k(s)} \right)^{-1/2} ds > d_i(x_i^o, x_i^e) \quad \text{for } i = 1, 2. \quad (2.8)$$

Up to a subsequence, we can assume that $\{\mu_i^n\}_n$ converges to μ_i , for all i , with $0 \leq \mu_1, \mu_2 \leq 1$ and $\mu_1 + \mu_2 = 1$. Moreover,

$$\left\{ \sqrt{\mu_i^n} \alpha_i(s)^{-1} \left(\sum_{k=1}^2 \mu_k^n \alpha_k(s)^{-1} \right)^{-1/2} \right\}_n \longrightarrow \sqrt{\mu_i} \alpha_i(s)^{-1} \left(\sum_{k=1}^2 \mu_k \alpha_k(s)^{-1} \right)^{-1/2} \quad (2.9)$$

uniformly on $[t^o, t^e + \delta]$ with $t^e + \delta < b$. Therefore, from (2.8) and (2.9), we deduce

$$\int_{t^o}^{t^e} \frac{\sqrt{\mu_i}}{\alpha_i(s)} \left(\sum_{k=1}^2 \frac{\mu_k}{\alpha_k(s)} \right)^{-1/2} ds \geq d_i(x_i^o, x_i^e), \quad \text{for } i = 1, 2.$$

If we consider $(t^o - 1/n, x_1^o, x_2^o)$, and modify slightly (μ_1, μ_2) , by continuity we obtain new coefficients (μ'_1, μ'_2) , with $\mu'_1, \mu'_2 > 0$ and $\mu'_1 + \mu'_2 = 1$, such that

$$\int_{t^o - 1/n}^{t^e} \frac{\sqrt{\mu'_i}}{\alpha_i(s)} \left(\sum_{k=1}^2 \frac{\mu'_k}{\alpha_k(s)} \right)^{-1/2} ds > d_i(x_i^o, x_i^e) \quad \text{for } i = 1, 2.$$

Again from Prop. 2.2, we have $(t^o - 1/n, x_1^o, x_2^o) \ll (t^e, x_1^e, x_2^e)$ for all n . So, taking into account that $I^-((t^o, x_1^o, x_2^o)) = \cup_{n \in \mathbb{N}} I^-((t^o - 1/n, x_1^o, x_2^o))$, we deduce the inclusion $I^-((t^o, x_1^o, x_2^o)) \subset I^-((t^e, x_1^e, x_2^e))$, as required. \square

Theorem 2.6. *A doubly warped spacetime (V, \mathfrak{g}) as in (2.2) is causally simple if and only if (M_i, h_i) is L_i -convex for $L_i = \int_a^b \frac{1}{\sqrt{\alpha_i(s)}} ds$, $i = 1, 2$.*

Proof. For the implication to the right, assume that (V, \mathfrak{g}) is causally simple. We will prove that (M_1, h_1) is L_1 -convex (the proof for the second fiber is analogous). Let $x_1^o, x_1^e \in M_1$ with $0 < d_1(x_1^o, x_1^e) < L_1$. Since $\int_a^b \frac{1}{\sqrt{\alpha_1(s)}} ds = L_1 > d_1(x_1^o, x_1^e)$, there exists $a < \mathfrak{d}_1 < \mathfrak{d}_2 < b$ such that

$$\int_{\mathfrak{d}_1}^{\mathfrak{d}_2} \frac{1}{\sqrt{\alpha_1(s)}} ds > d_1(x_1^o, x_1^e). \quad (2.10)$$

Fix $x_2 \in M_2$ and consider the points $(\mathfrak{d}_1, x_1^o, x_2)$ and $(\mathfrak{d}_2, x_1^e, x_2)$. Inequality (2.10) and Prop. 2.2 imply that $(\mathfrak{d}_2, x_1^e, x_2) \in I^+((\mathfrak{d}_1, x_1^o, x_2))$. Since $(\mathfrak{d}_1, x_1^e, x_2) \notin I^+((\mathfrak{d}_1, x_1^o, x_2))$, there exists $t^e \in \mathbb{R}$ such that $(t^e, x_1^e, x_2) \in \partial I^+((\mathfrak{d}_1, x_1^o, x_2))$, i.e.,

$$\begin{aligned} (t^e, x_1^e, x_2) &\in \overline{I^+((\mathfrak{d}_1, x_1^o, x_2))} \setminus I^+((\mathfrak{d}_1, x_1^o, x_2)) \\ &= J^+((\mathfrak{d}_1, x_1^o, x_2)) \setminus I^+((\mathfrak{d}_1, x_1^o, x_2)), \end{aligned}$$

where, in the equality, we have used that (V, \mathfrak{g}) is causally simple. Therefore, there exists a null geodesic $\gamma(s) = (t(s), c_1(s), c_2(s))$ connecting $(\mathfrak{d}_1, x_1^o, x_2)$ with (t^e, x_1^e, x_2) . From Prop. 2.4 there exist constants $\mu'_1, \mu'_2 \geq 0$ such that the following inequalities hold:

$$\begin{aligned} 0 < d_1(x_1^o, x_1^e) &\leq \int_{\mathfrak{d}_1}^{t^e} \frac{\sqrt{\mu'_1}}{\alpha_1(s)} \left(\sum_{k=1}^2 \frac{\mu'_k}{\alpha_k(s)} \right)^{-1/2} ds = \text{length}_1(c_1), \\ 0 = d_2(x_2, x_2) &\leq \int_{\mathfrak{d}_1}^{t^e} \frac{\sqrt{\mu'_2}}{\alpha_2(s)} \left(\sum_{k=1}^2 \frac{\mu'_k}{\alpha_k(s)} \right)^{-1/2} ds = \text{length}_2(c_2). \end{aligned}$$

So, taking into account that

$$(t^e, x_1^e, x_2) \notin I^+((\mathfrak{d}_1, x_1^o, x_2)),$$

the second inequality in the first line must be an equality (recall Prop. 2.2). In conclusion, $c_1(s)$ is a reparametrization of a minimizing geodesic of (M_1, h_1) , as required.

For the implication to the left, assume that (M_i, h_i) is L_i -convex for $L_i = \int_a^b \frac{1}{\sqrt{\alpha_i(s)}} ds$, $i = 1, 2$. In order to prove that (V, \mathfrak{g}) is causally simple, take $(t^e, x_1^e, x_2^e) \in \overline{I^+((t^o, x_1^o, x_2^o))} = \overline{I^+((t^o, x_1^o, x_2^o))}$.

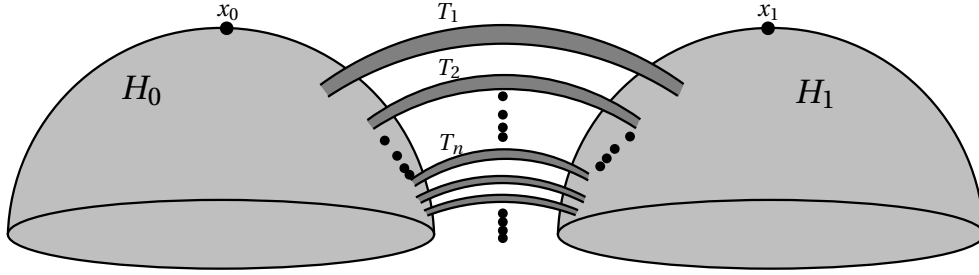

Figure 2.1: Both hemispheres H_0 and H_1 are connected by a sequence of immersed tubes $\{T_n\}_n$, where a length-minimizing curve connecting the north pole x_0 of H_0 to the north pole x_1 of H_1 through T_n has bigger length than a length-minimizing curve connecting the same points through T_{n+1} . This picture is based on [10, Figure 1].

Then, $I^+((t^e, x_1^e, x_2^e)) \subset I^+((t^o, x_1^o, x_2^o))$, and thus, $(t^e, x_1^o, x_2^o) \ll (t^e + 1/n, x_1^e, x_2^e)$ for all $n \in \mathbb{N}$. From Prop. 2.2, there exist constants $0 < \mu_1^n, \mu_2^n < 1$, with $\mu_1^n + \mu_2^n = 1$ for all n , such that

$$\int_{t^o}^{t^e+1/n} \frac{\sqrt{\mu_i^n}}{\alpha_i(s)} \left(\sum_{k=1}^2 \frac{\mu_k^n}{\alpha_k(s)} \right)^{-1/2} ds > d_i(x_i^o, x_i^e), \quad i = 1, 2.$$

Since $\{\mu_i^n\}_n$ converges (up to subsequence) to some $\mu_i \in [0, 1]$ for $i = 1, 2$, with $\mu_1 + \mu_2 = 1$, we have:

$$\frac{\sqrt{\mu_i^n}}{\alpha_i(s)} \left(\sum_{k=1}^2 \frac{\mu_k^n}{\alpha_k(s)} \right)^{-1/2} \rightarrow \frac{\sqrt{\mu_i}}{\alpha_i(s)} \left(\sum_{k=1}^2 \frac{\mu_k}{\alpha_k(s)} \right)^{-1/2} \quad \text{uniformly on } [t^o, t^e + \delta].$$

Recalling now that all previous functions are bounded by the (Lebesgue) integrable function $g : [t^o, t^e + \delta] \rightarrow \mathbb{R}$, $g(t) = \alpha_i(t)^{-1/2}$, with $t^e + \delta < b$, the Dominated Convergence Theorem ensures that:

$$\int_{t^o}^{t^e} \frac{\sqrt{\mu_i}}{\alpha_i(s)} \left(\sum_{k=1}^2 \frac{\mu_k}{\alpha_k(s)} \right)^{-1/2} ds = \lim_{n \rightarrow \infty} \int_{t^o}^{t^e+1/n} \frac{\sqrt{\mu_i^n}}{\alpha_i(s)} \left(\sum_{k=1}^2 \frac{\mu_k^n}{\alpha_k(s)} \right)^{-1/2} ds \geq d_i(x_i^o, x_i^e).$$

In particular,

$$d_i(x_i^o, x_i^e) < \int_a^b \frac{\sqrt{\mu_i}}{\alpha_i(s)} \left(\sum_{k=1}^2 \frac{\mu_k}{\alpha_k(s)} \right)^{-1/2} ds \leq \int_a^b \frac{1}{\sqrt{\alpha_i(s)}} ds = L_i, \quad i = 1, 2.$$

So, taking into account that (M_i, h_i) are L_i -convex for $i = 1, 2$ we have that Prop. 2.4 implies $(t^e, x_1^e, x_2^e) \in J^+((t^o, x_1^o, x_2^o))$, as required. \square

The following example shows the tight character of Thm. 2.6, in the sense that there may exist causally simple warped spacetimes with non-convex fiber (the extension to the case of two fibers is straightforward). In fact:

Example 2.7. In [10, Section 2.1] the authors construct a Riemannian manifold (M, h) containing two points $x_0, x_1 \in M$ such that any geodesic $\gamma \subset M$ connecting them satisfies $\text{length}(\gamma) > d_h(x_0, x_1)$. The example basically consists of two open hemispheres H_0, H_1 in \mathbb{R}^3 connected by a sequence of immersed tubes $(T_n)_n$ of decreasing lengths, and such that any curve joining the corresponding north poles x_0 and x_1 through T_n is longer than a minimizing curve joining them through T_{n+1} (see Figure 2.1). It is assumed also that the lengths of these tubes converge

to a number which is strictly positive. In particular, x_0 and x_1 cannot be joined by a minimizing geodesic, and thus, (M, h) is not convex. However, there exists some $\delta > 0$ such that (M, h) is L -convex for any $L \leq \delta$. Consider now the warped spacetime $V = \mathbb{R} \times_{\alpha} M$ with $\alpha : \mathbb{R} \rightarrow (0, \infty)$ satisfying $\int_{-\infty}^{+\infty} 1/\sqrt{\alpha(s)} ds = L \leq \delta$. From Thm. 2.6, V is causally simple.

Finally, for the sake of completeness, we include the following simple consequence of [11, Thm. 3.68], whose implication to the left is reproved here by using the techniques developed in this chapter:

Theorem 2.8. *A doubly warped spacetime (V, g) as in (2.2) is globally hyperbolic if and only if (M_i, h_i) , $i = 1, 2$, are complete Riemannian manifolds.*

Proof. Assume that (M_i, h_i) , $i = 1, 2$, are complete. Since (V, g) is causally continuous, and thus, causal, it suffices to prove that any causal diamond is sequentially compact (and thus, compact). Let $(t^o, x_1^o, x_2^o), (t^e, x_1^e, x_2^e) \in V$ and $\{(t^n, x_1^n, x_2^n)\}_n$ be a sequence in $J^+((t^o, x_1^o, x_2^o)) \cap J^-((t^e, x_1^e, x_2^e))$. Since the fibers are complete, they are convex, and so, we can apply Prop. 2.4. Hence, there exist constants $0 \leq \mu_1^n, \mu_2^n \leq 1$, $0 \leq \bar{\mu}_1^n, \bar{\mu}_2^n \leq 1$ with $\mu_1^n + \mu_2^n = 1 = \bar{\mu}_1^n + \bar{\mu}_2^n$ for all n , such that

$$\begin{aligned} \int_{t^o}^{t^n} \frac{\sqrt{\mu_i^n}}{\alpha_i(s)} \left(\sum_{k=1}^2 \frac{\mu_k^n}{\alpha_k(s)} \right)^{-1/2} ds &\geq d_i(x_i^o, x_i^n) \\ \int_{t^n}^{t^e} \frac{\sqrt{\bar{\mu}_i^n}}{\alpha_i(s)} \left(\sum_{k=1}^2 \frac{\bar{\mu}_k^n}{\alpha_k(s)} \right)^{-1/2} ds &\geq d_i(x_i^n, x_i^e), \end{aligned} \quad i = 1, 2.$$

In particular, the following inequalities hold for all n and $i = 1, 2$:

$$t^o \leq t^n \leq t^e \quad \text{and} \quad \int_{t^o}^{t^e} \frac{1}{\sqrt{\alpha_i(s)}} ds \geq \left(\int_{t^o}^{t^e} \frac{\sqrt{\mu_i^n}}{\alpha_i(s)} \left(\sum_{k=1}^2 \frac{\mu_k^n}{\alpha_k(s)} \right)^{-1/2} ds \right) d_i(x_i^o, x_i^n).$$

That is, $t^n \in [t^o, t^e]$ and $x_i^n \in \bar{B}_{r_i}(x_i^o)$, $r_i := \int_{t^o}^{t^e} \alpha_i^{-1/2} ds$, $i = 1, 2$, for large n . But, $[t^o, t^e]$ and $\bar{B}_{r_i}(x_i^o)$, $i = 1, 2$, are compact sets (recall that (M_i, h_i) , $i = 1, 2$, are complete). So, up to a subsequence, $\{(t^n, x_1^n, x_2^n)\}_n$ converges to some point $(t^*, x_1, x_2) \in V$, which necessarily lies into the (closed) causal diamond $J^+((t^o, x_1^o, x_2^o)) \cap J^-((t^e, x_1^e, x_2^e))$. In conclusion, the causal diamond is sequentially compact, and so, (V, g) is globally hyperbolic. \square

2.2 Case of interest: Generalized Robertson-Walker model

Before we study the future causal completion of doubly warped spacetimes, let us restrict our attention to the future c-completion of Robertson-Walker models. In order to obtain it, we will reproduce the study developed in [36, Section 3] adapted to this particular setting.

Let (V, g) be a *Generalized Robertson-Walker model*, that is, $V = (a, b) \times M$ and

$$g = -dt^2 + \alpha h,$$

where $\alpha : (a, b) \rightarrow (0, \infty)$ is a positive smooth function and (M, h) is a Riemannian manifold. This spacetime will be denoted by $(a, b) \times_{\alpha} M$ for short. Assume that the warping function α satisfies the following integral condition:

$$\int_a^b \frac{1}{\sqrt{\alpha(s)}} ds = \infty, \quad a < \vartheta < b. \quad (2.11)$$

Remark 2.9. The only difference between the spacetime model studied in [36] and the one considered here is that the temporal component \mathbb{R} and the integral conditions

$$\int_0^\infty \frac{1}{\sqrt{\alpha(s)}} ds = \int_{-\infty}^0 \frac{1}{\sqrt{\alpha(s)}} ds = \infty$$

have been replaced by a general interval (a, b) and just the integral condition (2.11). Nevertheless, the results established in this section are easily deducible by simple adaptations of the corresponding proofs in [36]. We leave the details to the reader interested on the subject.

The chronological relation can be characterized in terms of the warping function α and the distance d associated to (M, h) as follows:

$$\begin{aligned} (t^o, x^o) \ll (t^e, x^e) &\iff d(x^o, x^e) < \int_{t^o}^{t^e} \frac{1}{\sqrt{\alpha(s)}} ds \\ &\iff \int_0^{t^o} \frac{1}{\sqrt{\alpha(s)}} ds < \int_0^{t^e} \frac{1}{\sqrt{\alpha(s)}} ds - d(x^o, x^e). \end{aligned} \quad (2.12)$$

Take a future-directed timelike curve $\gamma : [\omega, \Omega) \rightarrow V$, which can be expressed without loss of generality as $\gamma(t) = (t, c(t))$. The function

$$t \mapsto \int_0^t \frac{1}{\sqrt{\alpha(s)}} ds - d(\cdot, c(t)) \quad (2.13)$$

is increasing with t (see [36, Prop. 3.1] for details). In particular, from (2.12),

$$\begin{aligned} P &= I^-(\gamma) \\ &= \left\{ (t^o, x^o) \in V : \int_0^{t^o} \frac{1}{\sqrt{\alpha(s)}} ds < \lim_{t \rightarrow \Omega} \left(\int_0^t \frac{1}{\sqrt{\alpha(s)}} ds - d(x^o, c(t)) \right) \right\}. \end{aligned} \quad (2.14)$$

Therefore, $P = P(b_c)$, where $b_c(\cdot) := \lim_{t \rightarrow \Omega} \left(\int_0^t \frac{1}{\sqrt{\alpha(s)}} ds - d(\cdot, c(t)) \right)$ is the *Busemann function associated to the curve c* and

$$P(f) := \{(t^o, x^o) \in V : \int_0^{t^o} \frac{1}{\sqrt{\alpha(s)}} ds < f(x^o)\}. \quad (2.15)$$

Summarizing, the future c -completion \hat{V} , i.e. the set of all IPs, can be identified with the set of all Busemann functions on M . So, if we denote by $B(M)$ the set of all finite Busemann functions, it follows that

$$\hat{V} \equiv B(M) \cup \{\infty\},$$

where ∞ represents the constantly infinite Busemann function, which is associated to the TIP $P(\infty) = V = i^+$.

Next, let us write $\hat{V} = (\hat{V} \setminus \hat{\partial}^b V) \cup \hat{\partial}^b V$, where $\hat{\partial}^b V$ denotes the TIPs obtained from inextendible future-directed timelike curves with divergent timelike component ($\Omega = b$). The finite Busemann functions associated to these curves are called *proper*, and the set of all of them is denoted by $\mathcal{B}(M)$. So,

$$\hat{\partial}^b V \equiv \mathcal{B}(M) \cup \{\infty\}.$$

In order to rewrite this set in a more appealing way, consider the quotient space (note that (2.11) guarantees that we have an \mathbb{R} -action on $\mathcal{B}(M)$)

$$\partial_{\mathcal{B}} M := \mathcal{B}(M) / \mathbb{R}$$

where two Busemann functions are \mathbb{R} -related if they differ only by a constant. Then, we can write

$$\hat{\partial}^b V \equiv (\mathbb{R} \times \partial_{\mathcal{B}} M) \cup \{\infty\},$$

and so, we can see the future c-boundary as a cone with base $\partial_{\mathcal{B}} M$ and apex $\{\infty\}$. This picture is reinforced by the fact that the generatrix lines of the cone are shown to be horismotic, that is, each couple of points on the same generatrix line are horismotically related (see [36, Section 3]).

The remaining set $(\hat{V} \setminus \hat{\partial}^b V)$ is formed by IPs obtained as the past of future-directed timelike curves $\gamma: [\omega, \Omega) \rightarrow V$, $\gamma(t) = (t, c(t))$, with $\Omega < b$. It can be proved that, in this case, $c(t) \rightarrow x^* \in M^C$, where M^C denotes the Cauchy completion of (M, h) , and so,

$$b_c(\cdot) = d_{(\Omega, x^*)}(\cdot) := \int_{\partial}^{\Omega} \frac{1}{\sqrt{\alpha(s)}} ds - d(\cdot, x^*) \quad (2.16)$$

(see [36, (3.7)]). In conclusion, we have the following identification

$$\hat{V} \setminus \hat{\partial}^b V \equiv (a, b) \times M^C, \quad (2.17)$$

which implies,

$$\hat{V} = \left(\hat{V} \setminus \hat{\partial}^b V \right) \cup \hat{\partial}^b V \equiv ((a, b) \times M^C) \cup (\mathbb{R} \times \partial_{\mathcal{B}} M) \cup \{\infty\}.$$

and

$$\hat{\partial} V = ((a, b) \times \partial^C M) \cup (\mathbb{R} \times \partial_{\mathcal{B}} M) \cup \{\infty\}.$$

Note that, given $P = P(b_c)$ and $P_n = P(b_{c_n})$,

$$\begin{aligned} P \subset \text{LI}(\{P_n\}_n) &\iff b_c \leq \liminf_n (b_{c_n}) \\ (\text{resp. } P \subset \text{LS}(\{P_n\}_n)) &\iff b_c \leq \limsup_n (b_{c_n}). \end{aligned} \quad (2.18)$$

This property joined to the identification between \hat{V} and $B(M)$ described above, suggests to translate the future chronological topology on \hat{V} into a (sequential) topology on $B(M)$, which is also called *future chronological topology* (see [36, Section 3.3]). The limit operator for this topology, also denoted by \hat{L} , is defined as follows:

$$f \in \hat{L}(\{f_n\}_n) \iff \begin{cases} (a) f \leq \liminf_n f_n \text{ and} \\ (b) \forall g \in B(M) \text{ with } f \leq g \leq \limsup_n f_n, \text{ it is } g = f. \end{cases} \quad (2.19)$$

The following result establishes the relation between this topology and the pointwise topology on $B(M)$ (see [36, Prop. 3.2] and [37, Prop. 5.29]):

Proposition 2.10. *Consider $\{f_n\}_n \subset B(M)$ a sequence which converges pointwise to a function $f \in B(M)$. Then, f is the unique future chronological limit of $\{f_n\}_n$. In particular, if $\{f_n\}_n = \{d_{(\Omega^n, x^n)}\}_n$ with $\Omega^n \rightarrow \Omega$ and $x^n \rightarrow x \in M^C$, then $f = d_{(\Omega, x)} \in \hat{L}(\{f_n\}_n)$ is the unique future chronological limit of $\{f_n\}_n$.*

Moreover, if M^C is locally compact, then the following converse follows: if $f = d_{(\Omega, x)} \in \hat{L}(\{f_n\}_n)$, then for n big enough $\{f_n\}_n = \{d_{(\Omega^n, x^n)}\}_n$ for some $\Omega^n \in \mathbb{R}$ and $x^n \in M^C$ satisfying that $\Omega^n \rightarrow \Omega$ and $x^n \rightarrow x \in M^C$.

Finally, note that the study of the past c-completion is very similar, just with some minor changes. First, the following integral condition is imposed:

$$\int_a^{\partial} \frac{1}{\sqrt{\alpha(s)}} ds = \infty.$$

Given a past-directed timelike curve $\gamma : [\omega, -\Omega] \rightarrow V$, $\gamma(t) = (-t, c(t))$, then $I^+(\gamma) = F(-b_c^-)$ where

$$F(f) := \{(t^o, x^o) \in V : \int_0^{t^o} \frac{1}{\sqrt{\alpha(s)}} ds > f(x^o)\}.$$

Moreover, the backward Busemann functions are written now as

$$b_c^-(\cdot) := \lim_{t \rightarrow -\Omega} \left(\int_{-t}^0 \frac{1}{\sqrt{\alpha(s)}} ds - d(\cdot, c(t)) \right).$$

The space of finite backward Busemann functions coincide with $B(M)$, so there is a natural bijection between the future and past c -completions. Moreover, when $-\Omega < -a$, then $c(t) \rightarrow x^* \in M^C$ and the backward Busemann function becomes (compare with (2.16))

$$b_c^-(\cdot) = d_{(\Omega, x^*)}^-(\cdot) = \int_{\Omega}^0 \frac{1}{\sqrt{\alpha(s)}} ds - d(\cdot, x^*). \quad (2.20)$$

In conclusion, one deduces

$$\check{V} \setminus \check{\partial}^a V \equiv (a, b) \times M^C,$$

and then,

$$\begin{aligned} \check{V} &\equiv B(M) \cup \{-\infty\} \\ &\equiv ((a, b) \times M^C) \cup (\mathcal{B}(M) \cup \{-\infty\}) \\ &\equiv ((a, b) \times M^C) \cup (\mathbb{R} \times \partial_{\mathcal{B}}(M)) \cup \{-\infty\}. \end{aligned}$$

2.3 The future c -completion of doubly warped spacetimes

In this section we are going to study the point set and topological structure of the future c -completion of doubly warped spacetimes, and we will improve the following result given in [56, Prop. 3.5]:

Proposition 2.11. (Harris, 2004) *Let (V, \mathfrak{g}) be a multiwarped spacetime as above, and assume that (for some $c \in (a, b)$) the first k warping functions, $1 \leq i \leq k$, obey $\int_c^b (\alpha_i(s))^{-1/2} ds < \infty$, and the rest, $k+1 \leq i \leq n$, obey $\int_c^b (\alpha_i(s))^{-1/2} ds = \infty$. Then the following hold:*

- (a) *If some Riemannian factor M_i is incomplete, the future causal boundary $\hat{\partial}V$ has timelike-related elements.*
- (b) *If M_i is not compact for some $i \geq k+1$, the future causal boundary $\hat{\partial}V$ has null-related elements.*
- (c) *If neither of those occur, then V has only spacelike future boundaries.*

In the last case, $\hat{\partial}V$ is homeomorphic to $M^0 = M_1 \times \cdots \times M_k$. Furthermore, the future causal completion \hat{V} is homeomorphic to $((a, b] \times M^0 \times M') / \sim$, where $M' = M_{k+1} \times \cdots \times M_n$ and \sim is the equivalence relation defined by $(b, x^0, x') \sim (b, x^0, y')$ for any $x^0 \in M^0$ and $x', y' \in M'$; $\hat{\partial}V$ appears there as $\{b\} \times M^0 \times \{*\}$.

So, let us begin by studying the chronological past of future directed timelike curves. Let $\gamma : [\omega, \Omega] \rightarrow V$, $\Omega \leq b$ be a future-directed timelike curve in V . We can reparametrize this curve by using the standard parameter t for the temporal component, $\gamma(t) = (t, c_1(t), c_2(t))$. So, from (2.4),

$$\text{length}(c_i |_{[\omega, \Omega]}) \leq \int_{\omega}^{\Omega} \frac{ds}{\sqrt{\alpha_i(s)}}. \quad (2.21)$$

Next, assume that $\Omega < b$. Then, the integral in (2.21) is finite. Hence, $\text{length}(c_i) < \infty$, and so, $c_i(t) \rightarrow x_i^*$ as $t \rightarrow \Omega$ for some $x_i^* \in M_i^C$, where M_i^C denotes the Cauchy completion of the Riemannian manifold (M_i, h_i) , $i = 1, 2$. If, in addition, $x_i^* \in M_i$ for $i = 1, 2$, the past of γ is clearly determined by the triple (Ω, x_1^*, x_2^*) . The following result shows that this is also true if x_i^* belongs to the Cauchy boundary $\partial^C M_i$ for some $i = 1, 2$.

Proposition 2.12. *Let $\gamma : [\omega, \Omega) \rightarrow V$, $\Omega < b$, be a future-directed timelike curve with $\gamma(t) = (t, c_1(t), c_2(t))$. Then, $\gamma(t) \rightarrow (\Omega, x_1^*, x_2^*) \in (a, b) \times M_1^C \times M_2^C$ as $t \rightarrow \Omega$ for some $(x_1^*, x_2^*) \in M_1^C \times M_2^C$. Moreover, $(t^o, x_1^o, x_2^o) \in I^-(\gamma)$ if, and only if, there exist constants $\mu_1, \mu_2 > 0$ with $\mu_1 + \mu_2 = 1$ and such that*

$$\int_{t^o}^{\Omega} \frac{\sqrt{\mu_i}}{\alpha_i(s)} \left(\sum_{k=1}^2 \frac{\mu_k}{\alpha_k(s)} \right)^{-1/2} ds > d_i(x_i^o, x_i^*) \quad \text{for } i = 1, 2. \quad (2.22)$$

Proof. As argued above, the first assertion is a direct consequence of (2.21). So, we only need to focus on the last assertion.

For the implication to the right, assume that $(t^o, x_1^o, x_2^o) \in I^-(\gamma)$. Since the chronological past $I^-(\gamma)$ is an open set, we can take $\epsilon > 0$ small enough so that $(t^o + \epsilon, x_1^o, x_2^o) \in I^-(\gamma)$. Consider an increasing sequence $\{t_n\} \subset [\omega, \Omega)$ with $t_n \nearrow \Omega$ and $(t^o + \epsilon, x_1^o, x_2^o) \ll \gamma(t_n)$ for all n . For each n , Thm. 2.2 ensures the existence of constants $\mu_1^n, \mu_2^n > 0$, with $\mu_1^n + \mu_2^n = 1$, such that:

$$\int_{t^o + \epsilon}^{t_n} \frac{\sqrt{\mu_i^n}}{\alpha_i(s)} \left(\sum_{k=1}^2 \frac{\mu_k^n}{\alpha_k(s)} \right)^{-1/2} ds > d_i(x_i^o, c_i(t_n)) \quad \text{for } i = 1, 2. \quad (2.23)$$

Observe that $\{c_i(t_n)\}_n \rightarrow x_i^* \in M_i^C$ for $i = 1, 2$, and so, from the continuity of the distance function $d_i(x_i^o, \cdot)$ on M_i^C , necessarily $\{d_i(x_i^o, c_i(t_n))\}_n \rightarrow d_i(x_i^o, x_i^*)$. Even more, since $\{\mu_i^n\}_n \subset [0, 1]$, we can assume that $\{\mu_i^n\}_n$ converges (up to a subsequence) to, say, μ_i^* , $i = 1, 2$, with $\mu_1^* + \mu_2^* = 1$. Hence,

$$\left\{ \frac{\sqrt{\mu_i^n}}{\alpha_i(s)} \left(\sum_{k=1}^2 \frac{\mu_k^n}{\alpha_k(s)} \right)^{-1/2} \right\}_n \rightarrow \frac{\sqrt{\mu_i^*}}{\alpha_i(s)} \left(\sum_{k=1}^2 \frac{\mu_k^*}{\alpha_k(s)} \right)^{-1/2} \quad \text{pointwise on } [t^o, \Omega].$$

Arguing as in the proof of Thm. 2.6, we observe that these functions are bounded by the integrable function $g : [t^o, \Omega] \rightarrow \mathbb{R}$, $g(t) = \alpha_i(t)^{-1/2}$, so the Dominated Convergence Theorem ensures that

$$\left\{ \int_{t^o + \epsilon}^{t_n} \frac{\sqrt{\mu_i^n}}{\alpha_i(s)} \left(\sum_{k=1}^2 \frac{\mu_k^n}{\alpha_k(s)} \right)^{-1/2} ds \right\}_n \rightarrow \int_{t^o + \epsilon}^{\Omega} \frac{\sqrt{\mu_i^*}}{\alpha_i(s)} \left(\sum_{k=1}^2 \frac{\mu_k^*}{\alpha_k(s)} \right)^{-1/2} ds.$$

In conclusion, by taking limits in (2.23), we arrive to

$$\int_{t^o + \epsilon}^{\Omega} \frac{\sqrt{\mu_i^*}}{\alpha_i(s)} \left(\sum_{k=1}^2 \frac{\mu_k^*}{\alpha_k(s)} \right)^{-1/2} ds \geq d_i(x_i^o, x_i^*) \quad \text{for } i = 1, 2.$$

In order to conclude the implication, it rests to show that, if $t^o + \epsilon$ is replaced by t^o , all previous inequalities are strict. In principle, the only way to avoid this conclusion is by assuming that some μ_i^* is equal to zero. If, say, $\mu_1^* = 0$ (and so, $\mu_2^* = 1$), then (i) $d_1(x_1^o, x_1^*) = 0$ and (ii)

$$\int_{t^o}^{\Omega} \frac{1}{\sqrt{\alpha_2(s)}} ds > d_2(x_2^o, x_2^*).$$

Reasoning as in the proof of Prop. 2.2, a small modification of μ_1^*, μ_2^* provides new constants $\mu_1, \mu_2 > 0$, with $\mu_1 + \mu_2 = 1$, such that

$$\begin{cases} \int_{t^o}^{\Omega} \frac{\sqrt{\mu_1}}{\alpha_i(s)} \left(\sum_{k=1}^2 \frac{\mu_k}{\alpha_k(s)} \right)^{-1/2} ds > 0 = d_1(x_1^o, x_1^*) \\ \int_{t^o}^{\Omega} \frac{\sqrt{\mu_2}}{\alpha_i(s)} \left(\sum_{k=1}^2 \frac{\mu_k}{\alpha_k(s)} \right)^{-1/2} ds > d_i(x_2^o, x_2^*), \end{cases}$$

and we are done.

For the converse, assume that (2.22) holds for some (t^o, x_1^o, x_2^o) and some constants $\mu_1, \mu_2 > 0$, with $\mu_1 + \mu_2 = 1$, and let us prove that $(t^o, x_1^o, x_2^o) \in I^-(\gamma)$. Recalling that the inequalities in (2.22) are strict and $\gamma(t) = (t, c_1(t), c_2(t)) \rightarrow (\Omega, x_1^*, x_2^*)$, there exists some $t^e \in (a, b)$ big enough such that

$$\int_{t^o}^{t^e} \frac{\sqrt{\mu_i}}{\alpha_i(s)} \left(\sum_{k=1}^2 \frac{\mu_k}{\alpha_k(s)} \right)^{-1/2} ds > d_i(x_i^o, c_i(t^e)) \quad \text{for } i = 1, 2.$$

Hence, from Prop. 2.2, $(t^o, x_1^o, x_2^o) \ll \gamma(t^e)$, as required. \square

We have just proved that the chronological past of a future-directed timelike curve γ defined on a finite interval $[\omega, \Omega)$, $\Omega < b$, is determined by its future limit point (Ω, x_1^*, x_2^*) , in the sense that any other future-directed timelike curve γ' with the same future limit point has the same chronological past. Next, we are going to prove that if γ' is another future-directed timelike curve converging to another triple, then it generates a different past set.

Proposition 2.13. *Let (V, g) be a doubly warped spacetime as in (2.2). If the timelike curves $\gamma^i : [\omega^i, \Omega^i) \rightarrow V$, $i = 1, 2$ satisfy $\gamma^i(t) \rightarrow p_i := (\Omega^i, x_1^i, x_2^i) \in (a, b) \times M_1^C \times M_2^C$ with $p_1 \neq p_2$ as $t \rightarrow \Omega^i$, then $I^-(\gamma^1) \neq I^-(\gamma^2)$.*

Proof. The conclusion easily follows if, say, $\Omega^1 < \Omega^2$, since in this case $\gamma^2(t) \in I^-(\gamma^2) \setminus I^-(\gamma^1)$ whenever $\Omega^1 < t < \Omega^2$. So, we will assume that $\Omega^1 = \Omega^2 (=:\Omega)$ and, say, $d_1(x_1^1, x_1^2) > 0$. Consider $\gamma^i(t) = (t, c_1^i(t), c_2^i(t))$ $i = 1, 2$. Let t^o be close enough to $\Omega < b$ so that (recall that $c_1^1(t) \rightarrow x_1^1$ as $t \rightarrow \Omega$)

$$\int_{t^o}^{\Omega} \frac{1}{\sqrt{\alpha_1(s)}} ds < \frac{d_1(x_1^1, x_1^2)}{3} \quad \text{and} \quad d_1(c_1^1(t^o), x_1^2) > \frac{d_1(x_1^1, x_1^2)}{3},$$

and define $q = \gamma^1(t^o) \in I^-(\gamma^1)$. Then, $q \notin I^-(\gamma^2)$, since, otherwise, from Prop. 2.12,

$$\int_{t^o}^{\Omega} \frac{\sqrt{\mu_1}}{\alpha_1(s)} \left(\sum_{k=1}^2 \frac{\mu_k}{\alpha_k(s)} \right)^{-1/2} ds > d_1(c_1^1(t^o), x_1^2) \quad \text{for some } \mu_1, \mu_2 > 0.$$

But this is not possible since, from the choice of t^o ,

$$d_1(c_1^1(t^o), x_1^2) > \frac{d_1(x_1^1, x_1^2)}{3} > \int_{t^o}^{\Omega} \frac{1}{\sqrt{\alpha_1(s)}} ds > \int_{t^o}^{\Omega} \frac{\sqrt{\mu_1'}}{\alpha_1(s)} \left(\sum_{k=1}^2 \frac{\mu_k'}{\alpha_k(s)} \right)^{-1/2} ds$$

for any positive constants μ_1', μ_2' , with $\mu_1' + \mu_2' = 1$. In conclusion, $I^-(\gamma^1) \neq I^-(\gamma^2)$ if $p_1 \neq p_2$, and the conclusion follows. \square

Remark 2.14. In the proof of previous propositions the key property is the finite value of the integral $\int_{t^o}^{\Omega} \alpha_i(s)^{-1/2} ds < \infty$, not the inequality $\Omega < b$. Of course, the second condition implies the first one, but the same argument can be reproduced if only the first condition holds.

Props. 2.12 and 2.13 together establish a natural bijection between the space $(a, b) \times M_1^C \times M_2^C$ and the set $\hat{V} \setminus \hat{\partial}^b V$, where $\hat{\partial}^b V$ denotes the set of TIPs determined by future-directed timelike curves with divergent temporal component ($\Omega = b$).

Convention. We will denote such a natural bijection (whose explicit form can be tracked easily from the context) with the symbol \leftrightarrow . Typically, when such a bijection has been established for a (partial) causal boundary, we will compare at what extent the bijection preserves other properties such as the topology or chronological relations.

Summing up:

Proposition 2.15. *Let (V, g) be a doubly warped spacetime as in (2.2). Then, there exists a bijection*

$$\hat{V} \setminus \hat{\partial}^b V \leftrightarrow (a, b) \times M_1^C \times M_2^C, \quad (2.24)$$

which maps each indecomposable past set $P \in \hat{V} \setminus \hat{\partial}^b V$ to the limit point $(\Omega, x_1^*, x_2^*) \in (a, b) \times M_1^C \times M_2^C$ of any future-directed timelike curve generating P .

Next, we are going to extend the point set structure obtained above to a topological level. We will consider $(a, b) \times M_1^C \times M_2^C$ attached with the product topology. The first result shows the continuity of bijection (2.24) in the left direction:

Proposition 2.16. *Let $P_n, P \in \hat{V} \setminus \hat{\partial}^b V$ with $P_n \equiv (\Omega_n, x_1^n, x_2^n)$ and $P \equiv (\Omega, x_1^*, x_2^*)$, where we are assuming that the triplets belong to $(a, b) \times M_1^C \times M_2^C$. If $(\Omega_n, x_1^n, x_2^n) \rightarrow (\Omega, x_1^*, x_2^*)$, then $P \in \hat{L}(\{P_n\}_n)$.*

Proof. First, recall the analytic characterization of the IPs P and P_n provided by Prop. 2.12: a point $(t, x_1, x_2) \in V$ belongs to P (resp. P_n) if, and only if, there exist positive constants μ_1, μ_2 (μ_1^n, μ_2^n) with $\mu_1 + \mu_2 = 1$ ($\mu_1^n + \mu_2^n = 1$) and satisfying that, for $i = 1, 2$:

$$\left(\int_t^\Omega \frac{\sqrt{\mu_i}}{\alpha_i(s)} \left(\sum_{k=1}^2 \frac{\mu_k}{\alpha_k(s)} \right)^{-1/2} ds > d_i(x_i, x_i^*) \right. \\ \left. \int_t^{\Omega_n} \frac{\sqrt{\mu_i^n}}{\alpha_i(s)} \left(\sum_{k=1}^2 \frac{\mu_k^n}{\alpha_k(s)} \right)^{-1/2} ds > d_i(x_i, x_i^n) \right)$$

Second, note that, from the hypotheses, the continuity of the distance map, and the Dominated Convergence Theorem, the following two limits hold: $d_i(x_i, x_i^n) \rightarrow d_i(x_i, x_i^*)$ and

$$\int_t^{\Omega_n} \frac{\sqrt{\mu_i}}{\alpha_i(s)} \left(\sum_{k=1}^2 \frac{\mu_k}{\alpha_k(s)} \right)^{-1/2} ds \rightarrow \int_t^\Omega \frac{\sqrt{\mu_i}}{\alpha_i(s)} \left(\sum_{k=1}^2 \frac{\mu_k}{\alpha_k(s)} \right)^{-1/2} ds \quad \text{for any } \mu_1, \mu_2 > 0.$$

These two properties directly imply both, $P \subset \text{LI}(\{P_n\})$ and P is maximal into $\text{LS}(\{P_n\})$, i.e., $P \in \hat{L}(\{P_n\})$. \square

In order to prove the continuity of bijection (2.24) in the right direction, we need to impose local compactness on the Cauchy completion since, otherwise, there exist counterexamples even in the one fibre case. For instance, on [37, Example 4.9] it is shown that in the classical comb space, where the Cauchy completion is not locally compact, both the chronological and the standard topology (inherited from \mathbb{R}^2) differ.

Proposition 2.17. *Let (V, g) be a doubly warped spacetime as in (2.2) with M_1^C and M_2^C locally compact. If $\{P_n\}_n$ is a sequence of IPs converging to some IP, $P \equiv (\Omega, x_1^*, x_2^*) \in (a, b) \times M_1^C \times M_2^C$, then $P_n \equiv (\Omega^n, x_1^n, x_2^n) \in (a, b) \times M_1^C \times M_2^C$ for n big enough, and $(\Omega^n, x_1^n, x_2^n) \rightarrow (\Omega, x_1^*, x_2^*)$ with the product topology. As consequence, the bijection (2.24) becomes a homeomorphism.*

Proof. The proof follows essentially in the same fashion as [37, Prop. 5.24].

Since the Cauchy completion $M_1^C \times M_2^C$ is locally compact, there exists a pre-compact neighbourhood U of $P \equiv (\Omega, x_1^*, x_2^*)$. Let $\{p_m^n\}_m, \{p_m\}_m \subset V$ be future chains generating P_n and P , resp. We can assume without restriction that $\{p_m\} \subset U$. It suffices to show the existence of n_0 and a map $m : \mathbb{N} \rightarrow \mathbb{N}$ such that $p_m^n \in U$ for all $n \geq n_0$ and $m \geq m(n)$. In fact, in this case, the temporal component of the sequence $\{p_m^n\}_m$ will not diverge as $m \rightarrow \infty$, and so, P_n can be identified with some $(\Omega^n, x_1^n, x_2^n) \in (a, b) \times M_1^C \times M_2^C \cap \bar{U}$. Moreover, since the result is valid for any pre-compact open set U , and (Ω, x_1^*, x_2^*) admits a countable local neighbourhood basis given by pre-compact open sets, necessarily $(\Omega^n, x_1^n, x_2^n) \rightarrow (\Omega_1^*, x_1^*, x_2^*)$.

In order to prove the statement in previous paragraph, assume by contradiction that, up to subsequences, p_m^n is not contained in U for all m and n . Since $P \subset LI(\{P_n\}_n)$, for each $m \in \mathbb{N}$ there exists n_0 such that $p_m \in P_n$ for all $n \geq n_0$. Consider a strictly increasing sequence $\{n(m)\}_m$ such that $p_m \in P_{n(m)}$. Denote by γ_m the future-directed timelike curve from p_m to some point of a future chain generating $P_{n(m)}$. Each γ_m intersects the boundary of \bar{U} at a point, say, (s^m, y_1^m, y_2^m) . Since U is pre-compact, its boundary is compact and we can assume (up to a subsequence) that $(s^m, y_1^m, y_2^m) \rightarrow (s^*, y_1^*, y_2^*)$ for some $(s^*, y_1^*, y_2^*) \in (a, b) \times M_1^C \times M_2^C$. Let us denote by P' the indecomposable set associated to $q = (s^*, y_1^*, y_2^*)$ which is necessarily different from P (as q belong to the boundary of U); and by $\{q_m\}_m$ a future chain generating P' . Next, we are going to show that P' breaks the maximality of P into $LS(\{P_n\})$, in contradiction with $P \in \hat{L}(\{P_n\}_n)$.

Let us show that $P' \subset LS(\{P_n\})$. First recall that, for each $m \in \mathbb{N}$, the set $I^+(q_m)$ is an open set containing q : in fact, this is straightforward if $q \in (a, b) \times M_1 \times M_2$; otherwise, it suffices to realize that the characterization of the chronological relation given in Prop. 2.2 (which is an open property) extends to the set $(a, b) \times M_1^C \times M_2^C$ (see Prop. 2.12). In particular, since $\{(s^k, y_1^k, y_2^k)\} \rightarrow q$, it follows that $(s^k, y_1^k, y_2^k) \in I^+(q_m)$ for k big enough. But, from construction, $(s^k, y_1^k, y_2^k) \in P_{n(k)}$, so $q_m \in P_{n(k)}$ for k big enough. Therefore, $P' \subset LS(\{P_{n(m)}\}_m)$.

It rests to show that $P \subsetneq P'$; that is, any point p_m of the future chain generating P is contained in P' . From construction, $p_m = (t^m, x_1^m, x_2^m) \ll p_k \ll (s^k, y_1^k, y_2^k)$ for all $k > m$. Let $\epsilon > 0$ be small enough so that $p_m^\epsilon = (t^m + \epsilon, x_1^m, x_2^m) \ll p_{m+1}$, and thus, $p_m^\epsilon \ll (s^k, y_1^k, y_2^k)$ for all $k > m$. From Prop. 2.2, there exist positive constants μ_1^k and μ_2^k , with $\mu_1^k + \mu_2^k = 1$, such that:

$$\int_{t^m + \epsilon}^{s^k} \frac{\sqrt{\mu_i^k}}{\alpha_i(s)} \left(\sum_{l=1}^2 \frac{\mu_l^k}{\alpha_k(s)} \right)^{-1/2} ds > d_i(x_i^m, y_i^k) \quad \text{for } i = 1, 2.$$

But $\{(s^k, y_1^k, y_2^k)\} \rightarrow (s^*, y_1^*, y_2^*)$. By continuity, and up to a subsequence, there exist positive constants μ_1^*, μ_2^* , with $\mu_1^* + \mu_2^* = 1$, such that:

$$\int_{t^m + \epsilon}^{s^*} \frac{\sqrt{\mu_i^*}}{\alpha_i(s)} \left(\sum_{l=1}^2 \frac{\mu_l^*}{\alpha_k(s)} \right)^{-1/2} ds \geq d_i(x_i^m, y_i^*) \quad \text{for } i = 1, 2.$$

Now if we replace in previous expression $t^m + \epsilon$ by t^m , at least one of previous inequalities becomes strict. Then, reasoning as in the proof of Prop. 2.2, we arrive to

$$\int_{t^m}^{s^*} \frac{\sqrt{\mu_i^*}}{\alpha_i(s)} \left(\sum_{l=1}^2 \frac{\mu_l^*}{\alpha_k(s)} \right)^{-1/2} ds > d_i(x_i^m, y_i^*) \quad \text{for } i = 1, 2,$$

for some slightly modified constants μ_i^* from μ_i^* . Therefore, the point p_m belongs to P' (recall Prop. 2.12). Since this argument works for any point of the sequence $\{p_m\}_m$ generating P , the inclusion $P \subsetneq P'$ follows.

For the last assertion, observe that the previous argument gives the continuity of bijection (2.24) to the right direction, while Prop. 2.16 ensures the continuity to the left one. \square

Next, we analyze the case $\Omega = b$. In this case, the finiteness/infiniteness of the integrals associated to the warping functions becomes crucial, so we will consider several subsections to discuss it.

2.3.1 Finite warping integrals

First, we consider the case when the integrals associated to the warping functions are both finite:

$$\int_{\mathfrak{d}}^b \frac{1}{\sqrt{\alpha_i(s)}} ds < \infty, \quad i = 1, 2 \quad \text{for some } \mathfrak{d} \in (a, b). \quad (2.25)$$

In this case, the following result provides the point set and topological structure of the future c -boundary:

Theorem 2.18. *Let (V, \mathfrak{g}) be a doubly warped spacetime as in (2.2), and assume that the integral conditions (2.25) hold. Then, there exists a bijection*

$$\hat{V} \leftrightarrow (a, b] \times M_1^C \times M_2^C \quad (2.26)$$

which maps each IP $P \in \hat{V}$ to the limit point $(\Omega, x_1, x_2) \in (a, b] \times M_1^C \times M_2^C$ of any future-directed timelike curve generating P . Moreover, if M_1^C, M_2^C are locally compact, this bijection becomes an homeomorphism.

Proof. For the first assertion, we only need to prove the corresponding bijection between $\hat{\mathfrak{d}}^b V$ and $\{b\} \times M_1^C \times M_2^C$ (recall Prop. 2.15). But this follows from the same arguments as in the proofs of Props. 2.12 and 2.13 (recall (2.25) and Remark 2.14).

For the second assertion, the continuity to the left of bijection (2.26) follows as in Prop. 2.16, just taking into account that the integral condition (2.25) must be used in order to apply the Dominated Convergence Theorem. For the continuity to the right, assume that $P \in \hat{L}(\{P_n\}_n)$, with $P = I^-(\gamma)$, $P_n = I^-(\gamma_n)$, and being $\gamma : [\omega, \Omega) \rightarrow V$, $\gamma_n : [\omega_n, \Omega_n) \rightarrow V$ future-directed timelike curves. Let (Ω, x_1^*, x_2^*) and (Ω_n, x_1^n, x_2^n) be the limit points in $(a, b] \times M_1^C \times M_2^C$ of γ and γ_n , resp. We need to prove that $(\Omega_n, x_1^n, x_2^n) \rightarrow (\Omega, x_1^*, x_2^*)$. Observe that, if $\Omega < b$, then the result follows from Prop. 2.17, so we will focus on the case $\Omega = b$.

First, note that $\Omega_n \rightarrow b$. In fact, otherwise, there exists $\Omega^* < b$ and a subsequence $\{\Omega_{n_k}\}$ such that $\Omega_{n_k} < \Omega^*$ for all $k \in \mathbb{N}$. But, in this case, P_{n_k} will not contain any point $\gamma(t)$ with $t > \Omega^*$, and so, $P \notin LI(\{P_n\})$.

Assume by contradiction that, say, $\{x_1^n\}_n$ does not converge to x_1^* . Then, up to a subsequence, there exists $\epsilon_0 > 0$ such that $d_1(x_1^n, x_1^*) > \epsilon_0$. Take t^0 big enough so that

$$\int_{t^0}^b \frac{1}{\sqrt{\alpha_1(s)}} ds < \frac{\epsilon_0}{3}.$$

Take $(x_1^o, x_2^o) \in M_1 \times M_2$ such that $q = (t^o, x_1^o, x_2^o) \in I^-(\gamma) = P$ with $d_1(x_1^o, x_1^*) < \epsilon_0/3$. It suffices to show that q does not belong to P_n for any n , since, in this case, we arrive to a contradiction with $P \subset LI(P_n)$. So, assume that $q \in P_n$ for all n . From Prop. 2.12, there exists some $\mu_1^n, \mu_2^n > 0$ such that

$$\int_{t^o}^{\Omega^n} \frac{\sqrt{\mu_1^n}}{\alpha_1(s)} \left(\sum_{k=1}^2 \frac{\mu_k^n}{\alpha_k(s)} \right)^{-1/2} ds > d_1(x_1^o, x_1^n).$$

This is in contradiction with the fact that, for any pair of positive constants $\mu'_1, \mu'_2 > 0$ with $\mu'_1 + \mu'_2 = 1$,

$$d_1(x_1^o, x_1^n) > d_1(x_1^*, x_1^n) - d_1(x_1^*, x_1^o) > \frac{2}{3}\epsilon_0 > \int_{t^o}^b \frac{1}{\sqrt{\alpha_1(s)}} ds > \int_{t^o}^b \frac{\sqrt{\mu'_1}}{\alpha_1(s)} \left(\sum_{k=1}^2 \frac{\mu'_k}{\alpha_k(s)} \right)^{-1/2} ds.$$

□

2.3.2 One infinite warping integral

Let us consider now the case when just one of the warping integrals is infinite, say:

$$\int_0^b \frac{1}{\sqrt{\alpha_1(s)}} ds < \infty \quad \text{and} \quad \int_0^b \frac{1}{\sqrt{\alpha_2(s)}} ds = \infty. \quad (2.27)$$

Point set structure

The first integral in condition (2.27) plus (2.21) ensures that any future-directed timelike curve $\gamma : [\omega, b) \rightarrow V$, $\gamma(t) = (t, c_1(t), c_2(t))$, satisfies that $c_1(t) \rightarrow x_1^* \in M_1^C$. Moreover, the second integral ensures that the associated Generalized Robertson-Walker spacetime $((a, b) \times M_2, -dt^2 + \alpha_2 h_2)$ corresponds with the model studied in Section 2.2. In particular, since the curve $\sigma(t) = (t, c_2(t))$ is also a future-directed timelike in that spacetime, we can consider the Busemann function $b_{c_2} \in B(M_2) \cup \{\infty\}$.

Next, our aim is to show that the chronological past of γ is determined by both, $x_1^* \in M_1^C$ and the Busemann function $b_{c_2} \in B(M_2) \cup \{\infty\}$. Let us begin with the following result:

Proposition 2.19. *Let (V, g) be a doubly warped spacetime and assume that the integral conditions (2.27) are satisfied. Consider two future-directed timelike curves $\gamma^i : [\omega, b) \rightarrow V$, $\gamma^i(t) = (t, c_1^i(t), c_2^i(t))$, with $c_1^i(t) \rightarrow x_1^* \in M_1^C$, $i = 1, 2$, as $t \rightarrow b$. If $(x_1^1, b_{c_2^1}) \neq (x_1^2, b_{c_2^2})$ then $I^-(\gamma^1) \neq I^-(\gamma^2)$.*

Proof. If $x_1^1 \neq x_1^2$, we can reason as in the proof of Prop. 2.13 (taking $\Omega = \Omega' = b$ and $x_1^1 \neq x_1^2$; Remark 2.14 and the first integral condition in (2.27)). So, it suffices to consider the case $b_{c_2^1} \neq b_{c_2^2}$.

From the timelike character of γ^i on V (for $i = 1, 2$), $\sigma_i(t) = (t, c_2^i(t))$ is also a future directed timelike curve on the Generalized Robertson-Walker spacetime $((a, b) \times M_2, -dt^2 + \alpha_2 h_2)$. Since $b_{c_2^1} \neq b_{c_2^2}$, necessarily $I^-(\sigma_1) \neq I^-(\sigma_2)$. Assume, for instance, that $(t^0, y_2) \in I^-(\sigma_2) \setminus I^-(\sigma_1)$ (the other case is analogous). Then, taking into account the characterization in (2.14), it follows that

$$b_{c_2^1}(y_2) \leq \int_0^{t^0} \frac{1}{\sqrt{\alpha_2(s)}} ds < b_{c_2^2}(y_2). \quad (2.28)$$

From the first inequality in (2.28),

$$\begin{aligned} (b_{c_2^1}(y_2) > b_{c_2^2}(y_2)) &\Rightarrow \lim_{t \rightarrow b} \left(\int_0^t \frac{1}{\sqrt{\alpha_2(s)}} ds - d_2(y_2, c_2^1(t)) \right) \leq \int_0^{t^0} \frac{1}{\sqrt{\alpha_2(s)}} ds \Rightarrow \\ &\Rightarrow \lim_{t \rightarrow b} \left(\int_{t^0}^t \frac{1}{\sqrt{\alpha_2(s)}} ds - d_2(y_2, c_2^1(t)) \right) \leq 0. \end{aligned}$$

Therefore, since the function $t \mapsto \left(\int_{t^0}^t \frac{1}{\sqrt{\alpha_2(s)}} ds - d_2(y_2, c_2^1(t)) \right)$ is increasing, we deduce

$$\int_{t^0}^t \frac{1}{\sqrt{\alpha_2(s)}} ds < d_2(y_2, c_2^1(t)) \quad \text{for all } t. \quad (2.29)$$

Let us show the existence of $x_1^o \in M_1$ such that $q = (t^o, x_1^o, y_2) \in I^-(\gamma^2)$. From the inequality

$$\int_0^{t^o} \frac{1}{\sqrt{\alpha_2(s)}} ds < b_{c_2^2}(y_2) = \lim_{t \rightarrow b} \left(\int_0^t \frac{1}{\sqrt{\alpha_2(s)}} ds - d_2(y_2, c_2^2(t)) \right),$$

there exists $t' > t^o$ big enough such that

$$\int_{t^o}^{t'} \frac{1}{\sqrt{\alpha_2(s)}} ds > d_2(y_2, c_2^2(t')).$$

From continuity, we can find positive constants μ_1, μ_2 , with $\mu_1 + \mu_2 = 1$, such that

$$\begin{cases} \int_{t^o}^{t'} \frac{\sqrt{\mu_2}}{\alpha_2(s)} \left(\sum_{k=1}^2 \frac{\mu_k}{\alpha_k(s)} \right)^{-1/2} ds > d_2(y_2, c_2^2(t')) \\ \int_{t^o}^{t'} \frac{\sqrt{\mu_1}}{\alpha_1(s)} \left(\sum_{k=1}^2 \frac{\mu_k}{\alpha_k(s)} \right)^{-1/2} ds > 0. \end{cases}$$

So, if we take x_1^o close enough to $c_1^2(t')$ so that

$$d_1(x_1^o, c_1^2(t')) < \int_{t^o}^{t'} \frac{\sqrt{\mu_1}}{\alpha_1(s)} \left(\sum_{k=1}^2 \frac{\mu_k}{\alpha_k(s)} \right)^{-1/2} ds,$$

Prop. 2.2 ensures that $(t^o, x_1^o, y_2) \ll \gamma^2(t')$, and thus, $q = (t^o, x_1^o, y_2) \in I^-(\gamma^2)$.

On the other hand, for any pair of positive constants $\mu_1, \mu_2 > 0$ with $\mu_1 + \mu_2 = 1$, necessarily

$$\int_{t^o}^t \frac{\sqrt{\mu_2}}{\alpha_2(s)} \left(\sum_{k=1}^2 \frac{\mu_k}{\alpha_k(s)} \right)^{-1/2} ds < \int_{t^o}^t \frac{1}{\sqrt{\alpha_2(s)}} ds < d_2(y_2, c_2^1(t)) \quad \text{for all } t > t^o,$$

where (2.29) has been used in the last inequality. Therefore, from Prop. 2.2, $q \not\ll \gamma^1(t)$ for all $t > t^o$, and thus, $q \notin I^-(\gamma^1)$. \square

Lemma 2.20. *Let $\gamma : [\omega, \Omega) \rightarrow V$, $\gamma(t) = (t, c_1(t), c_2(t))$ be a future-directed timelike curve with $c_1(t) \rightarrow x_1^* \in M_1^C$. If $\sigma = \{(t_n, x_1^n, c_2(t_n))\}_n \subset V$ satisfies $\{t_n\}_n \rightarrow \Omega$ and $x_1^n \rightarrow x_1^*$, then $I^-(\gamma) \subset LI(\{I^-(t_n, x_1^n, c_2(t_n))\}_n)$.*

Proof. Assume by contradiction the existence of some point $q = (t^o, x_1^o, x_2^o) \in I^-(\gamma)$ such that $q \not\ll (t_n, x_1^n, c_2(t_n))$ for infinitely many n . From the open character of the chronological relation, we can assume that $x_1^o \neq x_1^*$. Moreover, for $\epsilon > 0$ small enough, it follows that $q_\epsilon = (t^o + \epsilon, x_1^o, x_2^o) \in I^-(\gamma)$. Then $q_\epsilon \ll \gamma(t_n)$ definitively on n . From Prop. 2.2, there exist positive constants $\mu_1^n, \mu_2^n > 0$, with $\mu_1^n + \mu_2^n = 1$, such that

$$\int_{t^o+\epsilon}^{t_n} \frac{\sqrt{\mu_i^n}}{\alpha_i(s)} \left(\sum_{k=1}^2 \frac{\mu_k^n}{\alpha_k(s)} \right)^{-1/2} ds > d_i(x_i^o, c_i(t_n)) \quad \text{for } i = 1, 2.$$

We can assume without restriction that $\{\mu_i^n\}_n$ converges to some point μ_i^* , $i = 1, 2$. Since $q_\epsilon \notin I^-(t_n, x_1^n, c_2(t_n))$ (recall that $q \not\ll (t_n, x_1^n, c_2(t_n))$), necessarily

$$(d_1(x_1^o, c_1(t_n)) <) \int_{t^o+\epsilon}^{t_n} \frac{\sqrt{\mu_1^n}}{\alpha_1(s)} \left(\sum_{k=1}^2 \frac{\mu_k^n}{\alpha_k(s)} \right)^{-1/2} ds \leq d_1(x_1^o, x_1^n),$$

the last inequality by Prop. 2.2. From the hypothesis, the first and third element in previous expression converge to $d_1(x_1^o, x_1^*) > 0$. Moreover, from (2.27), the integral in the middle is also finite. Hence,

$$\left\{ \int_{t^o+\epsilon}^{t_n} \frac{\sqrt{\mu_1^n}}{\alpha_1(s)} \left(\sum_{k=1}^2 \frac{\mu_k^n}{\alpha_k(s)} \right)^{-1/2} ds \right\}_n \rightarrow \int_{t^o+\epsilon}^{\Omega} \frac{\sqrt{\mu_1^*}}{\alpha_1(s)} \left(\sum_{k=1}^2 \frac{\mu_k^*}{\alpha_k(s)} \right)^{-1/2} ds = d_1(x_1^o, x_1^*) < \infty. \quad (2.30)$$

In particular, since $x_1^o \neq x_1^*$, necessarily $\mu_1^* \neq 0$, and so,

$$\int_{t^o}^{\Omega} \frac{\sqrt{\mu_1^*}}{\alpha_1(s)} \left(\sum_{k=1}^2 \frac{\mu_k^*}{\alpha_k(s)} \right)^{-1/2} ds > d_1(x_1^o, x_1^*). \quad (2.31)$$

Finally, from (2.30) and (2.31),

$$\int_{t^o}^{t^n} \frac{\sqrt{\mu_1^n}}{\alpha_1} \left(\sum_{k=1}^2 \frac{\mu_k^n}{\alpha_k} \right)^{-1/2} ds > d_1(x_1^o, x_1^n) \quad \text{for } n \text{ big enough,}$$

which implies that $q = (t^o, x_1^o, x_2^o) \in I^-((t_n, x_1^n, c_2(t_n)))$ for n big enough, a contradiction. \square

This Lemma has the following consequence:

Proposition 2.21. *Let $\gamma^i : (\omega, b) \rightarrow V$, $\gamma^i(t) = (t, c_1^i(t), c_2^i(t))$, $i = 1, 2$, be a future-directed timelike curves. If $c_1^i(t) \rightarrow x_1^* \in M_1^C$, $i = 1, 2$, and $b_{c_2^1} = b_{c_2^2}$, then $I^-(\gamma^1) = I^-(\gamma^2)$.*

Proof. Let us prove that, say, $I^-(\gamma^1) \subset I^-(\gamma^2)$. Since $b_{c_2^1} = b_{c_2^2}$, we have that the curves $\sigma^i(t) = (t, c_1^i(t))$, $i = 1, 2$, have the same past on the Generalized Robertson-Walker spacetime $((a, b) \times M_2, -dt^2 + \alpha_2 h_2)$. Therefore, for any sequence $\{s_n\}_n \nearrow b$ there exists another sequence $\{t_n\}_n \rightarrow b$ such that

$$(s_n, c_2^1(s_n)) = \sigma^1(s_n) \ll \sigma^2(t_n) = (t_n, c_2^2(t_n)) \quad \text{for all } n,$$

and thus,

$$(s_n, c_2^2(t_n), c_1^1(s_n)) \ll (t_n, c_2^2(t_n), c_1^2(t_n)) = \gamma^2(t_n) \quad \text{on } V. \quad (2.32)$$

Next, observe that the sequence $\zeta = \{(s_n, c_1^2(t_n), c_2^1(s_n))\}_n$, which from (2.32) is contained in $I^-(\gamma^2)$, together with the curve γ^1 , satisfies the conditions in Lemma 2.20; in fact, $\{c_1^2(t_n)\}_n \rightarrow x_1^*$ as $\{t_n\}_n \rightarrow b$ and $c_1^1(t) \rightarrow x_1^*$ as $t \rightarrow b$. Therefore,

$$I^-(\gamma^1) \subset \text{LI}(\{I^-(s_n, c_1^2(t_n), c_2^1(s_n))\}_n) \subset I^-(\gamma^2)$$

as desired. Analogously, we can prove that $I^-(\gamma^2) \subset I^-(\gamma^1)$. \square

Summarizing, if we put together Props. 2.15, 2.19 and 2.21, we deduce the following point set structure for the future c-completion of (V, \mathfrak{g}) :

Theorem 2.22. *Let (V, \mathfrak{g}) be a doubly warped spacetime as in (2.2), and assume that the integral conditions (2.27) hold. Then, there exists a bijection*

$$\hat{V} \leftrightarrow M_1^C \times (B(M_2) \cup \{\infty\}) \equiv ((a, b) \times M_1^C \times M_2^C) \cup (M_1^C \times (\mathcal{B}(M_2) \cup \{\infty\})). \quad (2.33)$$

This bijection maps each indecomposable past set $P = I^-(\gamma) \in \hat{V}$, where $\gamma : (\omega, \Omega) \rightarrow V$, $\gamma(t) = (t, c_1(t), c_2(t))$, is any curve generating P , to a pair (x_1^, b_{c_2}) , where $x_1^* \in M_1^C$ is the limit point of the curve c_1 . If $\Omega < b$, then $b_{c_2} = d_{(\Omega, x_2^*)}$, where x_2^* is the limit point of c_2 (see (2.16)), and thus, P can be also identified with the limit point (Ω, x_1^*, x_2^*) of γ (recall Prop. 2.15).*

Topological Structure

Next, we are going to extend previous study to a topological level, showing that the bijection obtained above is actually a homeomorphism when the corresponding product topology on $M_1^C \times (B(M_2) \cup \{\infty\})$ is considered.

To this aim, we only need to prove the following equivalence: given $P \equiv (x_1^*, b_{c_2}) \in \hat{V}$ and $\{P_n\}_n \equiv \{(x_1^n, b_{c_2^n})\}_n \subset \hat{V}$,

$$P \in \hat{L}(\{P_n\}_n) \iff x_1^n \rightarrow x_1^* \text{ and } b_{c_2} \in \hat{L}(\{b_{c_2^n}\}_n). \quad (2.34)$$

Under the hypothesis of M_1^C and M_2^C being locally compact, the equivalence (2.34) for the case $b_{c_2} \equiv d_{(\Omega, x_2)}$ is already proved in Prop. 2.17. In fact, if $P_n = I^-(\gamma^n)$ with $\gamma^n : [\omega, \Omega_n] \rightarrow V$, then $\Omega_n < b$ for n big enough. In particular, $b_{c_2^n} \equiv d_{(\Omega_n, x_2^n)}$ with $x_2^n \in M_2^C$ (see (2.16)). Moreover, Prop. 2.17 implies that $(\Omega_n, x_1^n, x_2^n) \rightarrow (\Omega, x_1^*, x_2^*)$. Hence, $\{d_{(\Omega_n, x_2^n)}\}_n$ converges pointwise to $d_{(\Omega, x_2)}$, and thus, $d_{(\Omega, x_2)} \in \hat{L}(\{d_{(\Omega_n, x_2^n)}\}_n)$ (see Prop. 2.10). So, to finish the proof of (2.34), we can focus just on the case $b_{c_2} \in \mathcal{B}(M_2)$.

We begin with some preliminary results. The first one becomes central for the more shaded topological results.

Lemma 2.23. *Let $P, P' \in \hat{V}$ and $\{P_n\}_n \subset \hat{V}$, and assume that $P \equiv (x_1, b_{c_2}), P' \equiv (x_1', b_{c_2'})$ and $P_n \equiv (x_1^n, b_{c_2^n})$ belong to $M_1^C \times (B(M_2) \cup \{\infty\})$ for all n (recall the identification in (2.33)). Then, the following statements hold:*

(i) *If $x_1 = x_1'$, then*

$$b_{c_2} \leq b_{c_2'} \iff P \subset P'.$$

(ii) *If $x_1^n \rightarrow x_1$, then*

$$P \subset \text{LI}(\{P_n\}_n) \iff b_{c_2} \leq \liminf_n(\{b_{c_2^n}\}_n).$$

Proof. Let $\gamma : [\omega, \Omega] \rightarrow V$, $\gamma' : [\omega', \Omega'] \rightarrow V$ and $\gamma^n : [\omega^n, \Omega^n] \rightarrow V$ be future-directed timelike curves generating P, P' and P_n , resp. Assume that $\gamma(t) = (t, c_1(t), c_2(t))$ and $\gamma'(t) = (t, c_1'(t), c_2'(t))$ satisfy that $c_1(t) \rightarrow x_1$, $c_1'(t) \rightarrow x_1$ and $b_{c_2}, b_{c_2'}$ are their Busemann functions.

(i) First, let us prove the implication to the left. Consider the future-directed timelike curves $\sigma(t) = (t, c_2(t))$ and $\sigma'(t) = (t, c_2'(t))$ in the Generalized Robertson-Walker spacetime

$$((a, b) \times M_2, -dt^2 + \alpha_2 h_2).$$

Since $P \subset P'$, and the chronological relation between the corresponding points is preserved when one fibre is removed, necessarily $P(b_{c_2}) = I^-(\sigma) \subset I^-(\sigma') = P(b_{c_2'})$, and thus, $b_{c_2} \leq b_{c_2'}$ (recall (2.14) and (2.15)).

For the implication to the right, assume that $x_1 = x_1'$ and $b_{c_2} \leq b_{c_2'}$. It suffices to show the existence of a sequence $\zeta = (t_n, y_1^n, c_2(t_n))$ with $\{t_n\}_n \nearrow \Omega$, satisfying $\{y_1^n\}_n \rightarrow x_1$ and $\zeta \subset P'$. In fact, in this case, Lemma 2.20 ensures that $P \subset \text{LI}(\zeta)$ and, taking into account that $\zeta \subset P'$, necessarily $P \subset P'$.

To this aim, take $\{t_n\}_n \nearrow \Omega$ and observe that, by hypothesis, $b_{c_2} \leq b_{c_2'}$. So, in the Generalized Robertson-Walker spacetime $((a, b) \times M_2, -dt^2 + \alpha_2 h_2)$, the inclusion $P(b_{c_2}) \subset P(b_{c_2'})$ holds (recall equations (2.14) and (2.15)). In particular, since the future-directed timelike curves $\sigma(t) = (t, c_2(t))$ and $\sigma'(t) = (t, c_2'(t))$ satisfy $I^-(\sigma) = P(b_{c_2})$ and $I^-(\sigma') = P(b_{c_2'})$, there exists a sequence $\{s_n\}_n$, with $\{s_n\}_n \nearrow \Omega'$, such that $\sigma(t_n) = (t_n, c_2(t_n)) \ll (s_n, c_2'(s_n)) = \sigma'(s_n)$. Let us show that $\zeta = \{(t_n, c_1'(s_n), c_2(t_n))\}$ is the required sequence. From construction and the fact that $(t_n, c_1'(s_n), c_2(t_n)) \ll (s_n, c_1'(s_n), c_2'(s_n))$ in V for all n , necessarily $\zeta \subset P'$. Moreover, since $\{s_n\}_n \nearrow \Omega'$, necessarily $c_1'(s_n) \rightarrow x_1' = x_1$, as desired.

(ii) For the implication to the right, assume that $P \subset LI(\{P_n\}_n)$. Assume also that P_n is generated by a timelike curve $\gamma_n(t) = (t, c_1^n(t), c_2^n(t))$, and observe that $c_1^n(t) \rightarrow x_1^n$. Let us show that $b_{c_2} \leq \liminf(\{b_{c_2^n}\}_n)$. Denote by $\sigma(t) = (t, c_2(t))$ and $\sigma_n(t) = (t, c_2^n(t))$ future-directed timelike curves in the Generalized Robertson Walker model

$$((a, b) \times M_2, -dt^2 + \alpha_2 h_2).$$

Since $P \subset LI(\{P_n\}_n)$, necessarily

$$P(b_{c_2}) = I^-(\sigma) \subset LI(\{I^-(\sigma_n)\}_n) = LI(\{P(b_{c_2^n})\}_n)$$

(where we are considering past sets in the associated Generalized Robertson Walker model), and the conclusion follows from (2.18).

For the implication to the left, assume that $b_{c_2} \leq \liminf_n(\{b_{c_2^n}\}_n)$ and let us prove that $P \subset LI(\{P_n\}_n)$. Let $\{t_k\} \nearrow \Omega$ be an arbitrary sequence. For each k , and from the timelike character of γ , we have $(t_k, c_2(t_k)) \ll (t, c_2(t))$ in the Generalized Robertson-Walker spacetime $((a, b) \times M_2, -dt^2 + \alpha_2 h_2)$ for all $t > t_k$. From (2.12) and the increasing character of (2.13),

$$\int_0^{t_k} \frac{1}{\sqrt{\alpha_2(s)}} ds < b_{c_2}(c_2(t_k)) = \lim_{t \rightarrow \Omega} \left(\int_0^t \frac{1}{\sqrt{\alpha_2(s)}} ds - d_2(c_2(t_k), c_2(t)) \right).$$

Since $b_{c_2} \leq \liminf_n(\{b_{c_2^n}\}_n)$, there exists an increasing sequence $\{n_k\}_k$ such that

$$\int_0^{t_k} \frac{1}{\sqrt{\alpha_2(s)}} ds < b_{c_2^n}(c_2(t_k)) = \lim_{r \rightarrow \Omega_n} \left(\int_0^r \frac{1}{\sqrt{\alpha_2(s)}} ds - d_2(c_2(t_k), c_2^n(r)) \right) \quad \forall n \geq n_k. \quad (2.35)$$

For each $n_k \leq n < n_{k+1}$, consider $r_n \in (\omega_n, \Omega_n)$ such that

$$\int_0^{t_k} \frac{1}{\sqrt{\alpha_2(s)}} ds < \int_0^{r_n} \frac{1}{\sqrt{\alpha_2(s)}} ds - d_2(c_2(t_k), c_2^n(r_n)), \quad d_1(c_1^n(r_n), x_1^n) < \frac{1}{2^n}, \quad (2.36)$$

(for the first inequality recall (2.35); for the second one, recall that $c_1^n(t) \rightarrow x_1^n$). From the first inequality, it follows that

$$(t_k, c_2(t_k)) \ll (r_n, c_2^n(r_n)) \quad \text{for } n_k \leq n < n_{k+1} \text{ and all } k.$$

However, since $\{(t_k, c_2(t_k))\}$ is a chronological chain, the previous chronological relation is true for all $n \geq n_k$: in fact, if $n \geq n_k$, there exists $k' (\geq k)$ such that $n_k \leq n < n_{k'+1}$. As we have noted before $(t_{k'}, c_2(t_{k'})) \ll (r_n, c_2^n(r_n))$ but, taking into account $(t_k, c_2(t_k)) \ll (t_{k'}, c_2(t_{k'}))$, necessarily $(t_k, c_2(t_k)) \ll (r_n, c_2^n(r_n))$.

Next, define the sequence $\sigma = \{(l_n, c_1^n(r_n), c_2(l_n))\}_n$, where $l_n := t_k$ if $n_k \leq n < n_{k+1}$. Since $\{t_k\}_k \nearrow \Omega$, necessarily $\{l_n\}_n \rightarrow \Omega$. Moreover, since $(t_k, c_2(t_k)) \ll (r_n, c_2^n(r_n))$,

$$(l_n, c_1^n(r_n), c_2(l_n)) = (t_k, c_1^n(r_n), c_2(t_k)) \ll (r_n, c_1^n(r_n), c_2^n(r_n)) = \gamma^n(r_n),$$

hence $(l_n, c_1^n(r_n), c_2(l_n)) \in P_n$ for all n . Finally, note that σ satisfies the conditions of Lemma 2.20, as $\{l_n\}_n \rightarrow \Omega$ and $c_1^n(r_n) \rightarrow x_1$ (recall that $c_1^n(t) \rightarrow x_1^n$, $x_1^n \rightarrow x_1$ from hypothesis and the second inequality in (2.36)). Therefore,

$$P \subset LI(\{I^-(l_n, c_1^n(r_n), c_2(l_n))\}_n) \subset LI(\{P_n\}_n),$$

as desired. □

Proposition 2.24. *Let $P \in \hat{V}$ and $\{P_n\}_n \subset \hat{V}$, and assume that $P \equiv (x_1, b_{c_2})$ and $P_n \equiv (x_1^n, b_{c_2^n})$ (in $M_1^C \times (B(M_2) \cup \{\infty\})$) for all n . Then, $P \in \hat{L}(\{P_n\}_n)$ if, and only if, $x_1^n \rightarrow x_1$ and $b_{c_2} \in \hat{L}(\{b_{c_2^n}\}_n)$.*

Proof. For the implication to the right, and reasoning as in the proof of Thm. 2.18, it follows that $x_1^n \rightarrow x_1$ (recall the finite warping integral in (2.27) and Remark 2.14). Hence, we will focus on $b_{c_2} \in \hat{L}(\{b_{c_2^n}\})$. From Lemma 2.23 and the fact that $P \in \hat{L}(\{P_n\}_n)$, necessarily $b_{c_2} \leq \liminf(\{b_{c_2^n}\}_n)$. So, $b_{c_2} \in \hat{L}(\{b_{c_2^n}\})$ follows if we prove that b_{c_2} is maximal into $\limsup(\{b_{c_2^n}\}_n)$. Consider any $b_{\bar{c}_2}$ such that $b_{c_2} \leq b_{\bar{c}_2} \leq \limsup(\{b_{c_2^n}\}_n)$, and consider the associated past set $\bar{P} \equiv (x_1, b_{\bar{c}_2})$. Up to a subsequence, we can assume that $b_{\bar{c}_2} \leq \liminf(\{b_{c_2^n}\}_n)$. From Lemma 2.23, $P \subset \bar{P}$ and $\bar{P} \subset LI(\{P_n\}_n)$. But P is maximal into the superior limit of the sequence $\{P_n\}_n$, so necessarily $P = \bar{P}$. From Prop. 2.19 we have that $b_{c_2} = b_{\bar{c}_2}$ so the maximal character of b_{c_2} into $\limsup(\{b_{c_2^n}\}_n)$ is obtained.

For the implication to the left, first note that $P \subset LI(\{P_n\}_n)$ (recall Lemma 2.23 and the definition of \hat{L} for Busemann functions (2.19)). So, we only need to focus on the maximal character of P into $LS(\{P_n\}_n)$. Take \bar{P} an indecomposable past set with $P \subset \bar{P}$ and maximal into $LS(\{P_n\}_n)$, and let us prove that $P = \bar{P}$. Assume that $\bar{P} \equiv (\bar{x}_1, b_{\bar{c}_2})$. Up to a subsequence, we can also assume that $\bar{P} \subset LI(\{P_n\}_n)$, hence $\bar{P} \in \hat{L}(\{P_n\}_n)$. Hence, from the previous part, $x_1^n \rightarrow \bar{x}_1$. But, by hypothesis, $x_1^n \rightarrow x_1$, obtaining that $x_1 = \bar{x}_1$. Once this is observed, Lemma 2.23 ensures both, $b_{c_2} \leq b_{\bar{c}_2}$ and $b_{\bar{c}_2} \leq \limsup(\{b_{c_2^n}\})$. Since $b_{c_2} \in \hat{L}(\{b_{c_2^n}\})$, necessarily $b_{c_2} = b_{\bar{c}_2}$, and so, $P = \bar{P}$ (recall Prop. 2.21). \square

Summarizing, we are in conditions to deduce the following result:

Theorem 2.25. *Let (V, \mathfrak{g}) be a doubly warped spacetime as in (2.2), and assume that the integral conditions in (2.27) are satisfied. If M_1^C and M_2^C are locally compact, the bijection (2.33) becomes a homeomorphism.*

Proof. From Prop. 2.17, the bijection between $\hat{V} \setminus \hat{\partial}^b V$ and $(a, b) \times M_1^C \times M_2^C$ is a homeomorphism if we assume that M_1^C and M_2^C are locally compact. From Prop. 2.24, the homeomorphism can be extended to the bijection (2.33). \square

2.4 The past c -completion of doubly warped spacetimes

Obviously, similar arguments provide the corresponding results for the past c -completion:

Theorem 2.26. *Let (V, \mathfrak{g}) be a doubly warped spacetime as in (2.2), and assume that the integral conditions*

$$\int_a^{\mathfrak{d}} \frac{1}{\sqrt{\alpha_i(s)}} ds < \infty, \quad i = 1, 2 \quad \text{for some } \mathfrak{d} \in (a, b). \quad (2.37)$$

hold. Then, there exists a bijection

$$\check{V} \leftrightarrow [a, b) \times M_1^C \times M_2^C \quad (2.38)$$

which maps each IF $F \in \check{V}$ to the limit point $(\Omega, x_1, x_2) \in [a, b) \times M_1^C \times M_2^C$ of any past-directed timelike curve generating F . Moreover, if M_1^C and M_2^C are locally compact, then this bijection becomes a homeomorphism.

Theorem 2.27. *Let (V, \mathfrak{g}) be a doubly warped spacetime as in (2.2), and assume that the integral conditions*

$$\int_a^{\mathfrak{d}} \frac{1}{\sqrt{\alpha_1(s)}} ds < \infty \quad \text{and} \quad \int_a^{\mathfrak{d}} \frac{1}{\sqrt{\alpha_2(s)}} ds = \infty, \quad (2.39)$$

hold. Then, there exists a bijection

$$\check{V} \leftrightarrow M_1^C \times (B(M_2) \cup \{-\infty\}) \equiv ((a, b) \times M_1^C \times M_2^C) \cup M_1^C \times (\mathcal{B}(M_2) \cup \{-\infty\}). \quad (2.40)$$

This bijection maps each indecomposable future set $F = I^+(\gamma) \in \check{V}$, where $\gamma: [\omega, -\Omega) \rightarrow V$, $\gamma(t) = (-t, c_1(t), c_2(t))$, is any curve generating F , to a pair $(x_1^*, b_{c_2}^-)$, where $x_1^* \in M_1^C$ is the limit point of the curve c_1 . If $-\Omega < -a$, then $b_{c_2}^- = d_{(\Omega, x_2^*)}^-$, where x_2^* is the limit point of c_2 (see (2.20)), and thus, F can be also identified with the limit point (Ω, x_1^*, x_2^*) of γ . Moreover, if M_1^C and M_2^C are locally compact, then this bijection becomes a homeomorphism.

2.5 The total c-completion of doubly warped spacetimes

We are now in conditions to construct the (total) c-completion of doubly warped spacetimes by merging appropriately the future and past c-boundaries obtained in previous section.

To this aim, first we need to determine the S-relation between indecomposable sets. So, let $\gamma: [\omega, \Omega) \rightarrow V$, $\gamma(t) = (t, c_1(t), c_2(t))$, be an inextensible future-directed timelike curve. Clearly, if $\Omega = b$ then $\uparrow I^-(\gamma) = \emptyset$, and there are no IFs S-related to $I^-(\gamma)$. So, we will focus on the case $\Omega < b$.

Proposition 2.28. *Let (V, g) be a doubly warped spacetime and consider a future-directed (resp. past-directed) timelike curve γ with associated endpoint $(\Omega^+, x_1^*, x_2^*) \in (a, b) \times M_1^C \times M_2^C$ (resp. $(\Omega^-, y_1^*, y_2^*) \in (a, b) \times M_1^C \times M_2^C$). Then*

$$\begin{aligned} \uparrow I^-(\gamma) &= \{(t, x_1, x_2) \in V \mid \exists \mu_1, \mu_2 > 0 \text{ such that} \\ &\int_{\Omega^+}^t \frac{\sqrt{\mu_i}}{\alpha_i(s)} \left(\sum_{k=1}^2 \frac{\mu_k}{\alpha_k(s)} \right)^{-1/2} ds > d_i(x_i, x_i^*), i = 1, 2\}. \end{aligned} \quad (2.41)$$

(resp. $\downarrow I^+(\gamma) = \{(t, x_1, x_2) \in V \mid \exists \mu_1, \mu_2 > 0$ such that

$$\int_t^{\Omega^-} \frac{\sqrt{\mu_i}}{\alpha_i(s)} \left(\sum_{k=1}^2 \frac{\mu_k}{\alpha_k(s)} \right)^{-1/2} ds > d_i(x_i, y_i^*), i = 1, 2\}.$$

As consequence, if $P \in \hat{V}$ and $F \in \check{V}$ are associated to (Ω^+, x_1^*, x_2^*) and (Ω^-, y_1^*, y_2^*) in $(a, b) \times M_1^C \times M_2^C$, resp, then the following equivalence holds:

$$P \sim_S F \iff \Omega^- = \Omega^+ \text{ and } x_i^* = y_i^* \in M_i^C, i = 1, 2.$$

Proof. Assume that $\gamma: [\omega, \Omega^+) \rightarrow V$, $\gamma(t) = (t, c_1(t), c_2(t))$, is a future-directed timelike curve with associated endpoint $(\Omega^+, x_1^*, x_2^*) \in (a, b) \times M_1^C \times M_2^C$ (for the past is analogous). We need to show that $\uparrow I^-(\gamma) = A_{(\Omega, x_1^*, x_2^*)}$, where

$$\begin{aligned} A_{(\Omega, x_1^*, x_2^*)} &:= \{(r, x_1, x_2) \in V \mid \exists \mu_1, \mu_2 > 0 \text{ such that} \\ &\int_{\Omega^+}^r \frac{\sqrt{\mu_i}}{\alpha_i(s)} \left(\sum_{k=1}^2 \frac{\mu_k}{\alpha_k(s)} \right)^{-1/2} ds > d_i(x_i, x_i^*), i = 1, 2\}. \end{aligned}$$

For the inclusion to the right, take $(r, x_1, x_2) \in \uparrow I^-(\gamma)$ and $\epsilon > 0$ small so that $(r - \epsilon, x_1, x_2) \in \uparrow I^-(\gamma)$ (recall that the common future is open). For any sequence $\{t_n\}_n \nearrow \Omega^+$ we have $\gamma(t_n) \ll (r - \epsilon, x_1, x_2)$ for all n . From Prop. 2.2 there exist constants $\mu_1^n, \mu_2^n > 0$, with $\mu_1^n + \mu_2^n = 1$ for all n , such that

$$\int_{t_n}^{r-\epsilon} \frac{\sqrt{\mu_i^n}}{\alpha_i(s)} \left(\sum_{k=1}^2 \frac{\mu_k^n}{\alpha_k(s)} \right)^{-1/2} ds > d_i(x_i, c_i(t_n)) \quad \text{for } i = 1, 2.$$

Then, by the standard limit process, we deduce the following inequalities:

$$\int_{\Omega^+}^{r-\epsilon} \frac{\sqrt{\mu_i^*}}{\alpha_i(s)} \left(\sum_{k=1}^2 \frac{\mu_k^*}{\alpha_k(s)} \right)^{-1/2} ds \geq d_i(x_i, x_i^*), \quad i = 1, 2,$$

where μ_i^* is the limit (up to a subsequence) of $\{\mu_i^n\}$. Now observe that some of previous inequalities become strict if we replace $r - \epsilon$ by r . So, a small variation of μ_1^* and μ_2^* if necessary (concretely, if one of these constants is zero), provides positive constants $\mu'_1, \mu'_2 > 0$ satisfying

$$\int_{\Omega^+}^r \frac{\sqrt{\mu'_i}}{\alpha_i(s)} \left(\sum_{k=1}^2 \frac{\mu'_k}{\alpha_k(s)} \right)^{-1/2} ds > d_i(x_i, x_i^*), \quad i = 1, 2.$$

In particular, $(r, x_1, x_2) \in A_{(\Omega, x_1^*, x_2^*)}$, and so, $\uparrow I^-(\gamma) \subset A_{(\Omega, x_1^*, x_2^*)}$.

For the inclusion to the left, assume that $(r, x_1, x_2) \in A_{(\Omega, x_1^*, x_2^*)}$. By the continuity of both, the integral with respect to the lower limit of integration and the distance function, and the convergence of $\gamma(t) = (t, c_1(t), c_2(t))$ to (Ω, x_1^*, x_2^*) , we deduce that

$$\int_t^r \frac{\sqrt{\mu_i}}{\alpha_i(s)} \left(\sum_{k=1}^2 \frac{\mu_k}{\alpha_k(s)} \right)^{-1/2} ds > d_i(x_i, c_i(t)) \quad \text{for } t \text{ sufficiently close to } \Omega^+.$$

So, from Prop. 2.2, $\gamma(t) \ll (r, x_1, x_2)$ for all t , which implies $(r, x_1, x_2) \in \uparrow I^-(\gamma)$.

For the last assertion, assume that P is associated to $(\Omega^+, x_1^*, x_2^*) \in (a, b) \times M_1^C \times M_2^C$. From the first part of this proposition, $\uparrow P = A_{(\Omega^+, x_1^*, x_2^*)}$. Now observe that, from the analog of Prop. 2.12 for past-directed timelike curves, $A_{(\Omega^+, x_1^*, x_2^*)} = I^+(\sigma)$ where σ is any past-directed timelike curve converging to (Ω^+, x_1^*, x_2^*) . So, $F = I^+(\sigma)$ is the unique maximal IF into the common future of P . Reasoning analogously we deduce that P is the unique maximal IP into the common past of F . In conclusion, P is S -related just with the indecomposable future set F , and vice versa. \square

From this result it is clear that \bar{V} is simple as a point set (see Defn. 19). On the other hand, if we define

$$\partial^{ab} V := \hat{\partial}^b V \cup \check{\partial}^a V,$$

the following identification is deduced:

$$\bar{V} \setminus \partial^{ab} V \leftrightarrow (a, b) \times M_1^C \times M_2^C.$$

In particular, $\partial V \setminus \partial^{ab} V$ can be identified with a cone with base $(M_1^C \times M_2^C) \setminus (M_1 \times M_2)$. Moreover, if we assume that both M_1^C, M_2^C are locally compact, Prop. 2.17 ensures that previous bijection is a homeomorphism. Particularly, this proves that, given $(P, F) \in \bar{V} \setminus \partial^{ab} V$,

$$P \in \hat{L}(\{P_n\}) \iff F \in \check{L}(\{F_n\})$$

for any sequence $\{(P_n, F_n)\}_n \in \bar{V}$. Hence, $\bar{V} \setminus \partial^{ab} V$ is also simple topologically.

Finally, the following lemma ensures that the line over each point $(x_1^*, x_2^*) \in (M_1^C \times M_2^C) \setminus (M_1 \times M_2)$ is timelike:

Lemma 2.29. *If $(P, F), (P', F') \in \partial V \setminus \partial^{ab} V$, with $(P, F) \equiv (\Omega, x_1^*, x_2^*), (P', F') \equiv (\Omega', x_1^*, x_2^*)$ in $(a, b) \times M_1^C \times M_2^C$, satisfy that $a < \Omega < \Omega' < b$ then $(P, F) \ll (P', F')$.*

Proof. Take $t = (\Omega + \Omega')/2$ and $\mu_1 = \mu_2 = 1/2$. For $i = 1, 2$, consider y_i close enough to x_i^* so that

$$\begin{cases} \int_t^{\Omega'} \frac{\sqrt{\mu_i}}{\alpha_i(s)} \left(\sum_{k=1}^2 \frac{\mu_k}{\alpha_k(s)} \right)^{-1/2} ds > d_i(y_i, x_i^*) \\ \int_{\Omega}^t \frac{\sqrt{\mu_i}}{\alpha_i(s)} \left(\sum_{k=1}^2 \frac{\mu_k}{\alpha_k(s)} \right)^{-1/2} ds > d_i(y_i, x_i^*), \end{cases} \quad i = 1, 2.$$

From Prop. 2.12 (and its past analogous) we deduce that $(t, y_1, y_2) \in F \cap P'$, as desired. \square

The S-relation described in Prop. 2.28 implies that each pair $(P, F) \in \bar{V}$ is determined by any of its non-empty components, that is, \bar{V} is simple as a point set. Even more, from Prop. 2.17 and the definition of the chronological limit (see (3), (4) and (7)), \bar{V} is topologically simple as well (recall Defn. 19); concretely, if $(P, F) \in \bar{V}$, $P \neq \emptyset$, and $\sigma = \{(P_n, F_n)\}_n \subset \bar{V}$, then $(P, F) \in L_{chr}(\sigma)$ if, and only if, $P \in \hat{L}_{chr}(\{P_n\}_n)$. Therefore, in order to determine the, pointwise and topological, structure of the (total) c -boundary, it suffices to study the partial boundaries. Consequently, we will describe \bar{V} in two different ways, according to our convenience, namely:

$$\bar{V} = ((a, b) \times M_1^C \times M_2^C) \cup \hat{\partial}^b V \cup \check{\partial}^a V = \hat{V} \cup \check{\partial}^a V = \hat{\partial}^b V \cup \check{V}.$$

Restricting conveniently, the open sets of \bar{V} containing a pair (P, F) can be viewed as: (i) open sets in $(a, b) \times M_1^C \times M_2^C$ if $P \neq \emptyset \neq F$, (ii) open sets in \hat{V} if $F = \emptyset$ or (iii) open sets in \check{V} if $P = \emptyset$.

It rests to determine the causal structure of \bar{V} . This is contained in the following result, which summarizes all the information about the (total) c -completion of doubly warped space-times:

Theorem 2.30. *Let (V, g) be a doubly warped spacetime as in (2.2). Then, there exists a homeomorphism*

$$\bar{V} \setminus \partial^{ab} V \leftrightarrow (a, b) \times M_1^C \times M_2^C,$$

where each line $\{(t, x_1^*, x_2^*) : t \in (a, b), (x_1^*, x_2^*) \in M_1^C \times M_2^C\}$ is timelike. Moreover:

- (i) If (2.25) and (2.37) hold, then $\partial^{ab} V$ is homeomorphic to a couple of spacelike copies of $M_1^C \times M_2^C$. As consequence, we have the following homeomorphism:

$$\bar{V} \leftrightarrow [a, b] \times M_1^C \times M_2^C \quad \text{pointwise and topologically.} \quad (2.42)$$

- (ii) If (2.27) and (2.37) hold, then $\partial^{ab} V$ has a copy of $M_1^C \times M_2^C$ for the past, with spatial causal character; and a copy of $M_1^C \times (\mathcal{B}(M_2) \cup \{\infty\})$ for the future. This second set can be seen as a cone with base $M_1^C \times \partial_{\mathcal{B}}(M_2)$ generated by horismotic lines over each pair $(x_1^*, [b_{c_2}])$ ending at the point (x_1^*, ∞) . As consequence, we have the following homeomorphism

$$\bar{V} \equiv \begin{cases} \check{V} \cup \hat{\partial}^b V \leftrightarrow ([a, b] \times M_1^C \times M_2^C) \cup (M_1^C \times (\mathcal{B}(M_2) \cup \{\infty\})) \\ \check{\partial}^a V \cup \hat{V} \leftrightarrow (\{a\} \times M_1^C \times M_2^C) \cup (M_1^C \times (B(M_2) \cup \{\infty\})). \end{cases}$$

- (iii) If (2.25) and (2.39) hold we have a structure analogous to (ii), but interchanging the roles of future and past, i.e.,

$$\bar{V} \equiv \begin{cases} \hat{\partial}^b V \cup \check{V} \leftrightarrow (\{b\} \times M_1^C \times M_2^C) \cup (M_1^C \times (B(M_2) \cup \{-\infty\})). \\ \hat{V} \cup \check{\partial}^a V \leftrightarrow ((a, b) \times M_1^C \times M_2^C) \cup (M_1^C \times (\mathcal{B}(M_2) \cup \{-\infty\})). \end{cases}$$

(iv) If (2.27) and (2.39) hold, then $\partial^{ab}V$ has two copies of the space $M_1^C \times (\mathcal{B}(M_2) \cup \{\infty\})$, one for the future and the other one for the past, formed by horismotic lines over each point $(x_1^*, [b_{c_2}]) \in M_1^C \times \partial_{\mathcal{B}}(M_2)$ ending at the point (x_1^*, ∞) . As consequence,

$$\bar{V} \equiv \begin{cases} \hat{\partial}^b V \cup \check{V} \leftrightarrow (M_1^C \times (\mathcal{B}(M_2) \cup \{\infty\})) \cup (M_1^C \times (B(M_2) \cup \{-\infty\})) \\ \hat{V} \cup \check{\partial}^a V \leftrightarrow (M_1^C \times (B(M_2) \cup \{\infty\})) \cup (M_1^C \times (\mathcal{B}(M_2) \cup \{-\infty\})). \end{cases}$$

Proof. As we have argued before, the first assertion about the point set topological and causal structure of $\bar{V} \setminus \partial^{ab}V$ is a direct consequence of Props. 2.15, 2.17 (and its past analogous), 2.28 and Lemma 2.29. So, we will focus on the rest of assertions.

- (i) The point set and topological structure are straightforward from Thms. 2.18 and 2.26. So, we only need to prove that $\partial^{ab}V = \hat{\partial}^b V \cup \check{\partial}^a V$ is spacelike. Take $(P, \varnothing), (P', \varnothing) \in \hat{\partial}^b V$ two different boundary points (for TIFs is completely analogous). By using the identification in (2.42), we can assume that $(P, \varnothing) \equiv (b, x_1^*, x_2^*)$ and $(P', \varnothing) \equiv (b, y_1^*, y_2^*)$ with $(x_1^*, x_2^*) \neq (y_1^*, y_2^*)$. From the proof of Prop. 2.13 (recall also Rem. 2.14) it follows both, $P \not\subset P'$ and $P' \not\subset P$, thus (P, \varnothing) and (P', \varnothing) are neither timelike nor lightlike related, i.e., they are spatially related.
- (ii) The point set and topological structure are deduced from Thm. 2.18 and Thm. 2.27. For the causal structure, let us take two points $(P, \varnothing), (P', \varnothing) \in \hat{\partial}^b V$ over the same point $(x_1^*, [b_{c_1}]) \in M_1^C \times \partial_{\mathcal{B}}M_2$. Hence, we can make the identifications $(P, \varnothing) \equiv (x_1^*, b_{c_1})$ and $(P', \varnothing) \equiv (x_1^*, b_{c_2})$ with $b_{c_1} - b_{c_2} = \mathcal{K}$, \mathcal{K} constant. If we assume that $\mathcal{K} > 0$, then $b_{c_1} \geq b_{c_2}$, and so, $P' \subset P$ (recall Lemma 2.23), i.e., both points are lightlike related (the case with $\mathcal{K} < 0$ is completely analogous).

Finally, assertions (iii) and (iv) are easily deduced from (i) and (ii). □

Remark 2.31. (1) Of course, the four cases considered in the previous theorem do not cover all the possibilities compatible with the finiteness of at most one warping integral (since the finite warping integral may not be necessarily the last one). However, the structure of the c-completion for these additional cases are easily deducible from our approach. The general situation where the finite warping integral is not necessarily the last one, and there are n fibres, is considered in the following section.

(2) There is an inherent difficulty associated to the case where multiple warping integrals are infinity. In this case, an eventual characterization of the chronological relation of the whole spacetime requires to work with some sort of Busemann functions involving the fibres associated to these warping functions. The fact that these warping functions may be different between them, makes highly unclear how to relate these Busemann functions with the geometric elements of each fibre, and so, prevents of a satisfactory description of the c-boundary for the whole spacetime in terms of the geometry of its fibres.

2.6 The general multiwarped case

In order to simplify the exposition, up to now we have considered multiwarped spacetimes with just two fibers. Even if the arguments and results for the general case are totally analogous, and can be easily deduced by the reader, we have devoted this section to explicitly write down the main results in the case of n fibres.

First, as a summary of the extensions of Thm. 2.5, Thm. 2.6 and Thm. 2.8 to multiwarped spacetimes we have:

Theorem 2.32. *Let (V, \mathfrak{g}) be a multiwarped spacetime as in (2.1), then the following statements hold:*

- (i) (V, \mathfrak{g}) is stably causal. And so, it is strongly causal, distinguishing, causal, chronological and non-totally vicious.
- (ii) (V, \mathfrak{g}) is causally continuous.
- (iii) (V, \mathfrak{g}) is causally simple if and only if (M_i, h_i) is L_i -convex for $L_i = \int_a^b \frac{1}{\sqrt{\alpha_i(s)}} ds$, $i = 1, 2, \dots, n$.
- (iv) (V, \mathfrak{g}) is globally hyperbolic if and only if (M_i, h_i) , $i = 1, 2, \dots, n$, are complete Riemannian manifolds.

Now, we give all the results that describe the future c-completion, past c-completion and the total c-completion of multiwarped spacetimes.

Theorem 2.33. *Let (V, \mathfrak{g}) be a multiwarped spacetime as in (2.1), and take any $\mathfrak{d} \in (a, b)$. Then, we have the following possibilities for the future c-completion of V :*

- (i) *If the integrals of the warping functions along $[\mathfrak{d}, b)$ are all finite, then*

$$\hat{V} \leftrightarrow (a, b] \times M_1^C \times \dots \times M_n^C.$$

- (ii) *If the integrals of the warping functions along $[\mathfrak{d}, b)$ are finite except the i -th one, then*

$$\hat{V} \leftrightarrow \prod_{k \neq i} M_k^C \times (B(M_i) \cup \{\infty\}) \equiv ((a, b) \times \prod_{k=1}^n M_k^C) \cup \left(\prod_{k \neq i} M_k^C \times (\mathcal{B}(M_i) \cup \{\infty\}) \right).$$

Theorem 2.34. *Let (V, \mathfrak{g}) be a multiwarped spacetime as in (2.1), and take any $\mathfrak{d} \in (a, b)$. Then, we have the following possibilities for the past c-completion of V :*

- (i) *If the integrals of the warping functions along $(a, \mathfrak{d}]$ are all finite, then*

$$\check{V} \leftrightarrow [a, \mathfrak{d}) \times M_1^C \times \dots \times M_n^C.$$

- (ii) *If the integrals of the warping functions along $(a, \mathfrak{d}]$ are finite except the j -th one, then*

$$\check{V} \leftrightarrow \prod_{k \neq j} M_k^C \times (B(M_j) \cup \{-\infty\}) \equiv ((a, \mathfrak{d}) \times \prod_{k=1}^n M_k^C) \cup \left(\prod_{k \neq j} M_k^C \times (\mathcal{B}(M_j) \cup \{-\infty\}) \right).$$

Theorem 2.35. *Let (V, \mathfrak{g}) be a multiwarped spacetime as in (2.1), and take any $\mathfrak{d} \in (a, b)$. Then, we have the following possibilities for the total c-completion of V :*

- (i) *If the integrals of the warping functions along both, $[\mathfrak{d}, b)$ and $(a, \mathfrak{d}]$, are all finite, then*

$$\bar{V} \leftrightarrow [a, b] \times M_1^C \times \dots \times M_n^C. \quad (2.43)$$

- (ii) *If the integrals of the warping functions along $(a, \mathfrak{d}]$ are all finite, and along $[\mathfrak{d}, b)$ are finite except the i -th one, then*

$$\bar{V} \equiv \begin{cases} \check{V} \cup \hat{\partial}^b V \leftrightarrow ([a, \mathfrak{d}) \times \prod_{k=1}^n M_k^C) \cup \left(\prod_{k \neq i} M_k^C \times (\mathcal{B}(M_i) \cup \{\infty\}) \right) \\ \check{\partial}^a V \cup \hat{V} \leftrightarrow (\{a\} \times \prod_{k=1}^n M_k^C) \cup \left(\prod_{k \neq i} M_k^C \times (B(M_i) \cup \{\infty\}) \right). \end{cases}$$

(iii) If the integrals of the warping functions along $[\partial, b)$ are all finite, and along $(a, \partial]$ are finite except the j -th one, then

$$\bar{V} \equiv \begin{cases} \hat{\partial}^b V \cup \check{V} \leftrightarrow (\{b\} \times \prod_{k=1}^n M_k^C) \cup (\prod_{k \neq j} M_k^C \times (B(M_j) \cup \{-\infty\})). \\ \hat{V} \cup \check{\partial}^a V \leftrightarrow ((a, b] \times \prod_{k=1}^n M_k^C) \cup (\prod_{k \neq j} M_k^C \times (\mathcal{B}(M_j) \cup \{-\infty\})) \end{cases}$$

(iv) If the integrals of the warping functions along $[\partial, b)$ are finite except the i -th one, and along $(a, \partial]$ are also finite except the j -th one, then

$$\bar{V} \equiv \begin{cases} \hat{\partial}^b V \cup \check{V} \leftrightarrow (\prod_{k \neq i} M_k^C \times (\mathcal{B}(M_i) \cup \{\infty\})) \cup (\prod_{k \neq j} M_k^C \times (B(M_j) \cup \{-\infty\})) \\ \hat{V} \cup \check{\partial}^a V \leftrightarrow (\prod_{k \neq i} M_k^C \times (B(M_i) \cup \{\infty\})) \cup (\prod_{k \neq j} M_k^C \times (\mathcal{B}(M_j) \cup \{-\infty\})). \end{cases}$$

2.7 Some examples of interest

In this section we are going to apply our results to compute the c-completion of some space-times of physical interest. Concretely, we will consider some Kasner models, the intermediate region of Reissner-Nordström and de Sitter models with (non necessarily compact) internal spaces.

Kasner models

Generalized Kasner models are multiwarped spacetimes (V, \mathfrak{g}) where $V = (0, \infty) \times \mathbb{R}^n$ and

$$\mathfrak{g} = -dt^2 + t^{2p_1} dx_1^2 + \dots + t^{2p_n} dx_n^2, \quad (p_1, \dots, p_n) \in \mathbb{R}^n. \quad (2.44)$$

These models are solutions to the vacuum Einstein equations if $(p_1, \dots, p_n) \in \mathbb{R}^n$ belongs to the so-called *Kasner sphere*, i.e., if it satisfies

$$\sum_{k=1}^n p_k = 1 = \sum_{k=1}^n p_k^2.$$

Even if this condition does not fall under the hypotheses of our results, this does not cover all the cases of interest, and so, we are not going to assume it.

As far as we know, the c-boundary of these models can be faced in two different ways. On the one hand, by using Harris' result (Prop. 2.11); taking into account that the fibers are complete, this result gives a full description of the future c-boundary when $p_k > 1$ for all k , and provides some partial information in the other cases. On the other hand, these models have been studied by García-Parrado and Senovilla in [45] by using the isocausal relation. They essentially prove that, depending on the values of the constants p_1, \dots, p_n , the corresponding Kasner model is isocausal to a particular Robertson-Walker model whose c-boundary is well-known. This may be useful, since, although the c-boundary of isocausal spacetimes may be different (see [39]), they can share some qualitative properties (see [36]).

Of course, Thm. 2.18 parallels Harris' result for Kasner models when $p_k > 1$ for all k . However, now we can go a step further and give a complete description of the c-boundary when

$$p_k > 1 \text{ for } 1 \leq k \leq i-1, \quad p_k = q \text{ for } i \leq k \leq n \quad \text{and} \quad \int_1^\infty \frac{1}{t^q} dt = \infty.$$

In this case we can write

$$V = (0, \infty) \times \mathbb{R}^{i-1} \times \mathbb{R}^{n-i+1}, \quad \mathfrak{g} = -dt^2 + \sum_{k=1}^{i-1} t^{2p_k} dx_k^2 + t^{2q} \left(\sum_{k=i}^n dx_k^2 \right),$$

In particular,

$$\int_1^\infty \frac{dt}{t^{pk}} < \infty, \quad k = 1, \dots, i-1, \quad \int_1^\infty \frac{dt}{t^q} = \infty.$$

Therefore, the spacetime falls under the hypotheses of Thm. 2.33 (ii), with $M_k = \mathbb{R}$ for $k = 1, \dots, i-1$, $M_i = \mathbb{R}^{n-i+1}$ and being i the number of fibres instead of n . This provides the following homeomorphism:

$$\hat{V} \leftrightarrow ((0, \infty) \times \mathbb{R}^n) \cup \left(\mathbb{R}^{i-1} \times \left(\mathcal{B}(\mathbb{R}^{n-i+1}) \cup \{\infty\} \right) \right).$$

So, taking into account that (see, for instance, [55, Section 5.1])

$$\mathcal{B}(\mathbb{R}^{n-i+1}) \cong \mathbb{R} \times \mathbb{S}^{n-i},$$

we immediately deduce that

$$\hat{\partial}V \leftrightarrow \mathbb{R}^{i-1} \times \left(\left(\mathbb{R} \times \mathbb{S}^{n-i} \right) \cup \{\infty\} \right).$$

The intermediate Reissner-Nordström

The Reissner-Nordström model is a spacetime (V, \mathfrak{g}) , where $V = \mathbb{R} \times \mathbb{R} \times \mathbb{S}^2$ and

$$\mathfrak{g} = - \left(1 - \frac{2m}{r} + \frac{q^2}{r^2} \right) dt^2 + \left(1 - \frac{2m}{r} + \frac{q^2}{r^2} \right)^{-1} dr^2 + r^2 (d\theta^2 + \sin^2\theta d\phi^2).$$

This metric degenerates at the zeros of the function $f(r) = (1 - 2m/r + q^2/r^2)$, which depend on the parameters m (mass) and q (charge). For our purposes we will require that $q \leq m$, which ensures the zeros $r^\pm = m \left(1 \pm \sqrt{1 - q^2/m^2} \right)$ for f . The *intermediate region* of the Reissner-Nordström is the spacetime (V_I, \mathfrak{g}) , where $V_I = \mathbb{R} \times (r^-, r^+) \times \mathbb{S}^2$.

Taking into account that $f(r) < 0$ on (r^-, r^+) , the metric \mathfrak{g} can be rewritten on V_I as

$$\mathfrak{g} = -f(r) dt^2 + \frac{1}{f(r)} dr^2 + r^2 d\sigma^2 = -d\tau^2 + r(\tau)^2 d\sigma^2 - F(\tau) dt^2, \quad (2.45)$$

where

$$d\tau := \frac{dr}{\sqrt{-f(r)}} = \frac{dr}{\sqrt{-1 + 2m/r - q^2/r^2}} \quad \text{and} \quad F(\tau) = f(r(\tau)).$$

Note that τ ranges in a finite interval (a, b) , and so, (V_I, \mathfrak{g}) clearly corresponds with the standard form of a doubly warped spacetime where $V_I = (a, b) \times \mathbb{S}^2 \times \mathbb{R}$. In order to proceed with the analysis of the c-completion of (V_I, \mathfrak{g}) , we need to distinguish two cases: $q \neq 0$ and $q = 0$.³

Intermediate Reissner-Nordström with charge, $q \neq 0$.

In this case, the warping integrals satisfy, for $a < \vartheta < b$,

$$\int_a^\vartheta \frac{1}{\sqrt{\alpha_1(\tau)}} d\tau = \int_{r^-}^{r^{(\vartheta)}} \frac{1}{r \sqrt{-1 + \frac{2m}{r} - \frac{q^2}{r^2}}} dr < \infty \quad (2.46)$$

$$\int_\vartheta^b \frac{1}{\sqrt{\alpha_1(\tau)}} d\tau = \int_{r^{(\vartheta)}}^{r^+} \frac{1}{r \sqrt{-1 + \frac{2m}{r} - \frac{q^2}{r^2}}} dr < \infty \quad (2.47)$$

³Since the Penrose's diagram of Reissner-Nordström is well-known (see, for instance, [61]), the c-completion of (V_I, \mathfrak{g}) can be also studied by applying [35, Thm. 4.32].

and

$$\int_a^{\partial} \frac{1}{\sqrt{\alpha_2(\tau)}} d\tau = \int_{r^-}^{r^{(0)}} \frac{1}{-1 + \frac{2m}{r} - \frac{q^2}{r^2}} dr = \infty \quad (2.48)$$

$$\int_{\partial}^b \frac{1}{\sqrt{\alpha_2(\tau)}} d\tau = \int_{r^{(0)}}^{r^+} \frac{1}{-1 + \frac{2m}{r} - \frac{q^2}{r^2}} dr = \infty. \quad (2.49)$$

So, from Thm. 2.30 (iv) (with $M_1 = \mathbb{S}^2$ and $M_2 = \mathbb{R}$), we deduce the homeomorphisms

$$\bar{V} \leftrightarrow ((a, b) \times \mathbb{S}^2 \times \mathbb{R}) \cup (\mathbb{S}^2 \times ((\mathbb{R} \times \{z^-, z^+\}) \cup \{i^+\})) \cup (\mathbb{S}^2 \times ((\mathbb{R} \times \{z^-, z^+\}) \cup \{i^-\})),$$

$$\partial V \leftrightarrow (\mathbb{S}^2 \times ((\mathbb{R} \times \{z^-, z^+\}) \cup \{i^+\})) \cup (\mathbb{S}^2 \times ((\mathbb{R} \times \{z^-, z^+\}) \cup \{i^-\})),$$

where we have used that $\mathcal{B}(\mathbb{R}) \equiv \mathbb{R} \times \{z^-, z^+\}$, being z^- and z^+ the two asymptotic directions (left and right) of \mathbb{R} .

Interior Schwarzschild, $q = 0$.

When $q = 0$, $f(r)$ has only one zero, we can identify $(r^-, r^+) \equiv (0, 2M)$, and the intermediate region of Reissner-Nordström coincides with the interior region of Schwarzschild. In this case, the warping integrals (2.46), (2.47) and (2.49) still hold, but (2.48) transforms into

$$\int_a^{\partial} \frac{1}{\sqrt{\alpha_2(\tau)}} d\tau = \int_0^{r^{(0)}} \frac{1}{-1 + \frac{2m}{r}} dr < \infty.$$

So, from Thm. 2.30 (iii), we deduce the homeomorphism

$$\bar{V} \leftrightarrow ([a, b) \times \mathbb{S}^2 \times \mathbb{R}) \cup (\mathbb{S}^2 \times (\mathbb{R} \times \{z^-, z^+\}))$$

and thus,⁴

$$\partial V \equiv \hat{\partial} V \cup \check{\partial} V \leftrightarrow (\{a\} \times \mathbb{S}^2 \times \mathbb{R}) \cup (\mathbb{S}^2 \times ((\mathbb{R} \times \{z^-, z^+\}) \cup \{i^+\})). \quad (2.50)$$

De Sitter models with (non-necessarily compact) internal spaces

Motivated by the relevance for the problem of the dS/CFT correspondence, finally we study the c-boundary of warped products of de Sitter models with complete Riemannian manifolds.

Recall that *de Sitter spacetime* can be seen as a Robertson-Walker spacetime (M, \mathfrak{g}_M) , where

$$M = \mathbb{R} \times \mathbb{S}^l, \quad \mathfrak{g}_M = -dt^2 + \cosh(t)^2 h_{\mathbb{S}^l}.$$

Consider the doubly warped spacetime (V, \mathfrak{g}) obtained as the product of de Sitter space (M, \mathfrak{g}_M) and a complete Riemannian manifold (F, h_F) , i.e.,

$$V = \mathbb{R} \times \mathbb{S}^l \times F, \quad \mathfrak{g} = -dt^2 + \cosh^2(t) h_{\mathbb{S}^l} + h_F.$$

The first warping function $\alpha_1(t) = \cosh(t)^2$ satisfies the finite integral conditions for both, the future and the past directions, meanwhile the second one $\alpha_2(t) \equiv 1$ does not. Therefore, from

⁴The usual time-orientation on Reissner-Nordström makes the vector field ∂_r past-directed in the intermediate region. So, in formula (2.50), the roles of the future and past c-boundaries are interchanged with respect to the (a priori) expected ones.

Thm. 2.30 (iv) (with $M_1 = \mathbb{S}^l$ and $M_2 = F$), we deduce the following homeomorphism for the c-boundary of (V, \mathfrak{g}) (recall that $\partial^C F = \partial^C \mathbb{S}^l = \emptyset$):

$$\partial V \equiv \hat{\partial} V \cup \check{\partial} V \leftrightarrow \left(\mathbb{S}^l \times (\mathcal{B}(F) \cup \{i^+\}) \right) \cup \left(\mathbb{S}^l \times (\mathcal{B}(F) \cup \{i^-\}) \right).$$

In particular, if (F, h_F) is compact, then $\mathcal{B}(F)$ is empty, and the c-boundary becomes (compare with the last assertion on Prop. 2.11):

$$\partial V \leftrightarrow \left(\mathbb{S}^l \times \{i^+\} \right) \cup \left(\mathbb{S}^l \times \{i^-\} \right).$$

Splitting of globally hyperbolic spacetimes with timelike boundary

Globally hyperbolic spacetimes with timelike boundary are the natural class of spacetimes containing (conformal) naked singularities where boundary conditions can be posed; such conditions can be regarded as asymptotic, when the boundary is obtained by means of a conformal embedding. In this chapter we extend the well-known splitting of globally hyperbolic spacetimes without boundary to a big class of causally continuous ones.

In Section 3.1, some basic preliminaries are introduced. They are essentially known from standard techniques but become relevant later. In Subsect. 3.1.1, the double manifold is used for extensions of the spacetime with boundary, relations between time-orientations and timelike vector fields of \bar{V} , ∂V and V are explained and Gaussian coordinates are introduced. In Subsect. 3.1.2, the causal ladder of spacetimes is introduced. Our choices in the definitions allow a reasonably self-contained development. In particular, the basic properties of the lower levels of the ladder (until stably causal) are quickly checked there. In Subsect. 3.1.3, H^1 -causal curves are introduced by following [19]. This allows to obtain intrinsically limit curves within the same class of curves (Prop. 3.16) and will circumvent subtleties which appear for standard causal-continuous curves.

In Section 3.2, all the framework of Geroch's topological splitting is revisited in order to include boundaries. In Subsect. 3.2.1, after checking that the role of admissible measures can be extended to the case with boundary, we reconstruct the higher levels of the causal ladder levels (Thm. 3.24), determine the causal properties inherited by the boundary ∂V and the interior V at each level, and provide the necessary (counter-) examples (Remark 3.25). In Subsect. 3.2.2, we go over Geroch's technique to find the required Cauchy time function (Thm. 3.27). However, for the sake of completeness, the properties of Cauchy hypersurfaces are developed in a more general setting for achronal subsets and edges in Subsect. 3.2.3. Some differences with the case without boundary are stressed (recall Remark 3.30) and Geroch's topological splitting is also extended to the case with boundary (Cor. 3.33).

3.1 Preliminaries on spacetimes with timelike boundary

3.1.1 Generalities: boundaries, time-orientation and coordinates

Manifolds with boundary. In what follows \bar{V} will denote a *connected n -manifold with boundary*, $n \geq 2$; any function or tensor field will be *smooth* when it is as differentiable as possible

(compatible with the C^r character of \bar{V}); typically, C^1 will be enough for the metric \mathfrak{g} . \bar{V} is then locally diffeomorphic to (open subsets of) a closed half space of \mathbb{R}^n ; V will denote its *interior* and ∂V its *boundary*. For any $p \in V$, $T_p \bar{V}$ will denote its n -dimensional tangent space while for $p \in \partial V$, $T_p \partial V$ is the $(n-1)$ -dimensional tangent space to the boundary. Such a \bar{V} can be regarded as a closed subset of the so-called *double manifold* \bar{V}^d , a C^r n -manifold (without boundary) obtained by taking two copies of \bar{V} and identifying analogous boundary points (in particular, partitions of unity for \bar{V} can be constructed from \bar{V}^d using $\bar{V}^d \setminus \bar{V}$ as an extra open subset), see [65, Section 9]. Lorentzian and Riemannian metrics on \bar{V} are particular cases of *semi-Riemannian metrics*, i.e. non-degenerate metric tensors (of constant index).

Proposition 3.1. *Regarding \bar{V} as a closed subset of \bar{V}^d , any semi-Riemannian metric \mathfrak{g} on \bar{V} can be extended to some open subset $\tilde{V} \subset \bar{V}^d$ (with $\bar{V} \subset \tilde{V}$).*

Proof. (See also [44, Lemma 2.3]) Working in coordinates around each $p \in \partial V \subset \bar{V}^d$, the metric \mathfrak{g} (i.e., its coordinate functions \mathfrak{g}_{ij} , defined on a closed subset) can be extended as a symmetric tensor $\mathfrak{g}^{(p)}$ defined on some open neighbourhood $U^{(p)} \ni p$ with $U^{(p)} \subset \bar{V}^d$. Consider the covering $\{U^{(p)}, p \in \partial V\} \cup \{V\}$ of some open subset $V^d \subset \bar{V}^d$ and take a subordinate partition of unity $\{\mu_{p_i}, i \in \mathbb{N}\} \cup \{\mu\}$, where $\text{Supp}(\mu_{p_i}) \subset U^{(p_i)}$, $\text{Supp}(\mu) \subset V$. The locally finite sum $\tilde{\mathfrak{g}} = \sum_i \mu_{p_i} \mathfrak{g}^{(p_i)} + \mu \mathfrak{g}$ extends \mathfrak{g} as a symmetric tensor, and it becomes non-degenerate (so, with constant index) in some neighbourhood $\tilde{V} \subset V^d \subset \bar{V}^d$ of \bar{V} . \square

Remark 3.2. In general, the natural extension to \bar{V}^d of the metric \mathfrak{g} defined in two copies of \bar{V} is only a C^0 metric. In the Riemannian case, \mathfrak{g} can be extended to all \bar{V}^d , but in the Lorentzian case this may be non-possible. For example, if \bar{V} is an even-dimensional closed half-sphere, \bar{V}^d admits no Lorentzian metric.

Further properties of manifolds with boundary can be seen in [65, Section 9], for example.

Time-orientation and spacetimes. Next, we recall some basic notions for the study of spacetimes with timelike boundary. Usual causal notions for Lorentzian manifolds without boundary such as causal or timelike vectors (following conventions in [83, 77]) are extended to the case with boundary with no further mention (see [43, 95] for further background).

Definition 3.3. *A Lorentzian manifold with timelike boundary (\bar{V}, \mathfrak{g}) , $\bar{V} = V \cup \partial V$, is a Lorentzian manifold with boundary such that the pullback $i^* \mathfrak{g}$ defines a Lorentzian metric on the boundary, where $i : \partial V \hookrightarrow \bar{V}$ is the natural inclusion. A spacetime with timelike boundary is a time-oriented Lorentzian manifold with timelike boundary.*

By *time-oriented* we mean that a time cone has been chosen *continuously* (i.e., locally selected by a continuous timelike vector field X) on all \bar{V} . The pull-back i^* will be dropped when there is no possibility of confusion and the time-orientation is assumed implicitly. If $\mathfrak{g}, \mathfrak{g}'$ are two Lorentzian metrics for spacetimes on \bar{V} , the notation $\mathfrak{g} < \mathfrak{g}'$ (resp. $\mathfrak{g} \leq \mathfrak{g}'$) means that any future-directed causal vector for \mathfrak{g} is future-directed timelike (resp. causal) for \mathfrak{g}' . The following result ensures that no additional issue on time-orientations appears because of the boundary (its proof uses standard background for the case without boundary, see [83, Lemma 5.32, Prop. 5.37]).

Proposition 3.4. *The following properties are equivalent for any Lorentzian manifold with timelike boundary (\bar{V}, \mathfrak{g}) :*

- (i) (\bar{V}, \mathfrak{g}) is time-orientable

(ii) (V, \mathfrak{g}) and $(\partial V, \mathfrak{g})$ are time-orientable

(iii) There exists a timelike vector field T on all \overline{V} tangent to $T_{\hat{p}}\partial V$ at each $\hat{p} \in \partial V$.

(iv) There exists a timelike vector field T on all \overline{V} .

Therefore, for any spacetime with timelike boundary, any connected component of its boundary is naturally a spacetime (without boundary)¹.

Proof. (i) \Rightarrow (ii) Notice that if X selects the time-orientation on some neighbourhood $U \subset \overline{V}$, then its orthogonal projection selects continuously a time orientation on $U \cap \partial V$.

(ii) \Rightarrow (iii) As (V, \mathfrak{g}) has no boundary, it admits a smooth timelike vector field T^V , and each connected part C of ∂V will admit also a timelike vector field T^C . For each $\hat{p} \in C$, consider a coordinate chart $(U_{\hat{p}}, (x^0, x^1, \dots, s))$ adapted to the boundary, i.e. $s^{-1}(0) = U_{\hat{p}} \cap C$, and extend the (restricted) vector field $T^C|_{U_{\hat{p}} \cap C}$ to the coordinate chart $U_{\hat{p}}$ by making the components of the vector field independent of the s coordinate. Let $T^C[\hat{p}]$ be such an extension. As the points where the time orientations selected by $T^C[\hat{p}]$ and T^V agree are both, open and closed, we can choose T^C so that both agree for all $T^C[\hat{p}]$, $\hat{p} \in C$. Repeating this for all the connected components of ∂V , considering the covering of \overline{V} provided by V and all $U_{\hat{p}}$, $\hat{p} \in \partial V$, and taking a partition of unity subordinate to this covering, one gets a timelike vector field T^0 defined on some neighbourhood U of ∂V which is also tangent to ∂V . So, if $\{\mu, 1 - \mu\}$ is a partition of the unity of ∂V subordinate to the covering $\{U, V\}$, the required vector field is just $T = \mu T^0 + (1 - \mu)T^V$.

The implications (iii) \Rightarrow (iv), (iv) \Rightarrow (i) and the last assertion are trivial. \square

Gaussian coordinates. Sometimes the following coordinates specially well adapted to the boundary will be useful. Let $\hat{p} \in \partial V$ and take a chart in the boundary $(\hat{U}, x^0, x^1, \dots, x^{n-2})$, with $\hat{U} \subset \partial V$ connected and relatively compact, $\mathfrak{g}(\partial_0, \partial_0) = -1$ on all \hat{U} , ∂_0 future-directed, and being $\{\partial_0, \dots, \partial_{n-2}\}$ an orthonormal base of $T_{\hat{p}}\partial V$. Since ∂V is timelike, there exists a unitary spacelike vector field N on ∂V which is orthogonal to the boundary and points out into V . Extend the previous coordinate system to a chart of \hat{p} in \overline{V} by using the geodesics with initial data (q, N_q) , $q \in \hat{U}$, that is, consider the geodesic $\gamma_q(s) = \exp_q(s \cdot N_q)$, $s \geq 0$, and regard its affine parameter s as a transverse coordinate. This provides the required coordinate system $(\hat{U} \times [0, s_+), (x^0, x^1, \dots, x^{n-2}, x^{n-1} = s))$ of \overline{V} for some $s_+ > 0$ small enough. Since $\partial_s|_{\partial V} = N$ is orthogonal to the boundary, $\mathfrak{g}(\partial_s, \partial_j) = 0$ on $\hat{U} \times [0, s_+)$ for all $j = 0, \dots, n-2$ (see for example [101, pp. 42-43]) and the metric \mathfrak{g} can be written as

$$\mathfrak{g} = \sum_{i,j=0}^{n-2} \mathfrak{g}_{ij}(\hat{x}, s) dx^i dx^j + ds^2, \quad \text{where } \hat{x} = (x^0, x^1, \dots, x^{n-2}). \quad (3.1)$$

Any coordinate system constructed as above will be called a *Gaussian chart adapted to the boundary*, or just Gaussian coordinates. When necessary, the image of the coordinates will be a *cube*, that is, $(-e, e)^{n-1} \times [0, e)$ for some $e > 0$. When $p \in V$, the name *Gaussian coordinates* will refer just a normal neighbourhood of p , and a *cube* to $(-e, e)^n$.

3.1.2 Conditions on causality

For any spacetime with timelike boundary $(\overline{V}, \mathfrak{g})$, the usual notation $\ll, \leq, I^\pm(p), J^\pm(p)$, will be used for the chronological and causal relations and the chronological or causal future/past of any $p \in \overline{V}$; so, $J^+(p, U)$ will denote the causal future obtained by using curves entirely contained

¹The boundary ∂V could be possibly non-connected.

in any $U \subset \bar{V}$ (and, accordingly \ll_U will be used); in particular, $p \in U$ would be implicitly assumed, and $J^+(p, V)$ would agree with the causal future of p in the spacetime (V, g) . In what follows cl will denote closure.

Proposition 3.5. (a) The binary relation \ll is open (in particular, $I^\pm(p)$ are open in \bar{V}). (b) For any $p, q, r \in \bar{V}$, $p \ll q \leq r \Rightarrow p \ll r$, $p \leq q \ll r \Rightarrow p \ll r$. (c) $J^\pm(p) \subset cl(I^\pm(p))$. (d) $I^\pm(p, V) = I^\pm(p) \cap V$ for all $p \in V$.

Proof. Properties (a), (b), (c) are easy to check (see [95, Prop. 3.5, 3.6, 3.7]). To prove $I^+(p, V) = I^+(p) \cap V$, the inclusion \subset is trivial. So, let $q \in I^+(p) \cap V$, and take some (piecewise smooth) future-directed timelike $\gamma : [0, 1] \rightarrow \bar{V}$ with $\gamma(0) = p, \gamma(1) = q \in V$. Consider any vector field $N \in \mathfrak{X}(\bar{V})$ which extends the pointing-inwards unit normal on ∂V (this can be always done, as ∂V is closed), any smooth function $f : [0, 1] \rightarrow \mathbb{R}^+$ vanishing only at 0, 1, and the vector field V on γ defined by $V(t) = f(t)N_{\gamma(t)}$ for all $t \in [0, 1]$. For any fixed-endpoints variation of γ with variational vector V , longitudinal curves close to γ are still timelike and cannot touch ∂V , so $q \in I^+(p, V)$. \square

In the case of spacetimes without boundary, there is a well-known causal ladder of spacetimes, each step admitting several characterizations (see [77]). Most of the ladder and characterizations can be transplanted directly to the case with timelike boundary. Here, we will focus just on the splitting of globally hyperbolic spacetimes, and the systematic study of other causal subtleties is postponed. So, we will make a fast summary of the standard steps of the ladder just making simple choices on the definitions and properties to be used in a self-contained way.

A spacetime with timelike boundary is *chronological* (resp. *causal*) if it does not contain closed timelike (resp. closed) causal curves and *strongly causal* if for all $p \in \bar{V}$ and any neighbourhood $U \ni p$ there exists another neighbourhood $U' \subset U$, $p \in U'$, such that any causal curve with endpoints at U' is entirely contained in U . Clearly, the latter condition is more restrictive than the others, and all of them are inherited by the interior V and the boundary ∂V .

Definition 3.6. A subset W of a spacetime with timelike boundary (\bar{V}, g) is *causally convex* if $J^+(x) \cap J^-(y) \subset W$ for any $x, y \in W$ (equivalently, if any causal curve with endpoints in W must remain in W).

Given an open neighbourhood $U \subset \bar{V}$, $W \subset U$, W is *causally convex in U* when W is *causally convex as a subset of U* , regarding U as a spacetime in its own right.

Notice that causally convex neighborhoods are not convex in the sense that each two of its points can be connected by a unique geodesic (indeed, the possibility to find such subsets depends on the second fundamental form of the boundary). However, given two points which are causally related in the intrinsic causality of the causally convex subset, a connecting causal curve of maximal length will be found there. Such a curve may have smooth pieces which are geodesics for V or ∂V with the restricted metric.

Proposition 3.7. (\bar{V}, g) is *strongly causal* if and only if each $p \in \bar{V}$ admits arbitrarily small causally convex neighbourhoods, that is, for any neighbourhood $U \ni p$ there exists a causally convex neighbourhood $W \ni p$ contained in U . In this case:

(a) The spacetime is also future (resp. past) distinguishing, that is, the equality $I^+(p) = I^+(q)$ (resp. $I^-(p) = I^-(q)$) implies $p = q$ (equally, the set-valued map $I^+ : \bar{V} \rightarrow P(\bar{V})$ (resp. $I^- : \bar{V} \rightarrow P(\bar{V})$), where $P(\bar{V})$ is the power set of \bar{V} , is one-to-one).

(b) Causal curves are not partially imprisoned on a compact sets, that is, for any future-directed causal curve $\gamma : [a, b) \rightarrow \bar{V}$, $a < b \leq \infty$ which cannot be extended continuously to b and any compact set $K \subset \bar{V}$ there exists some $s_0 \in [a, b)$ such that $\gamma(s) \notin K$ for all $s \geq s_0$.

Proof. For the implication to the right (to the left is trivial), it is enough to show that, given an open neighbourhood U of p , there exists a smaller neighbourhood $U' \subset U$, $p \in U'$, and a sequence of nested causally convex neighbourhoods $\{W_m\}$, $W_{m+1} \subset W_m$, $p = \bigcap_m W_m$, such that each W_m is causally convex in U' . This can be proved as in the case without boundary [77, Thm. 2.14, Lemma 2.13] (now requiring the nested neighbourhoods just to be causally convex instead of globally hyperbolic). Namely, given U , one takes (Gaussian) coordinates centered at p , (U', x^i) , $U' \subset U$, a standard flat metric g^+ in these coordinates with $g < g^+$ (say, $g^+ = -\epsilon(dx^0)^2 + \sum_i (dx^i)^2 + ds^2$, with $\epsilon > 0$ small and, eventually, choosing a smaller U') and $W_m = I^+(x^0 = -1/m, 0, \dots, 0) \cap I^-(x^0 = 1/m, 0, \dots, 0)$ for large m .

(a) Following the reasoning as in the case without boundary [77, Lemma 3.10] assume by contradiction, say, $I^+(p) = I^+(q)$ with $p \neq q$. No neighbourhood U_p of p such that $q \notin cl(U_p)$ will admit an open set U'_p with $p \in U'_p \subset U_p$ which is causally convex in U_p . Indeed, take $z \in I^+(p) \cap U'_p$ and note that $z \in I^+(q)$. So, there exists a future-directed timelike curve $\gamma : [0, 1] \rightarrow \bar{V}$ joining q with z . Let $s_0 > 0$ be small enough so that $\gamma(s_0) \notin U'_p$, and note that $\gamma(s_0) \in I^+(q) = I^+(p)$. Then, there exists a future-directed timelike curve σ joining p with $\gamma(s_0)$. The natural concatenation $(\gamma|_{[s_0, 1]} * \sigma)$ is a future-directed timelike curve with endpoints in U'_p that leaves U_p , a contradiction.

(b) A simple proof follows exactly as in case without boundary (see [11, Prop. 3.13] or [83, Lemma 14.13]; see also [77, Sect. 3.6.2]). More precisely, let $K \subset \bar{V}$ be a compact set and $\gamma : [a, b] \rightarrow \bar{V}$, $a < b \leq \infty$ a future directed causal curve which cannot be extended continuously to b . Suppose by contradiction that either γ is contained in K or that γ leaves and enters the compact set K . Then, there exists $\{s_n\} \subset [a, b)$ with $s_n \rightarrow b$ and $\gamma(s_n) \in K$. From the compactness of K , $\gamma(s_n)$ converges (up to a subsequence) to some $p \in K$, since $\gamma(t)$ is an inextensible curve in \bar{V} . Then, there exists another sequence $\{t_n\} \subset [a, b)$ with $t_n \rightarrow b$ and $\gamma(t_n) \not\rightarrow p$. So, there exists some $U \subset \bar{V}$ neighbourhood of p such that $\gamma(t_n) \notin U$. We can take subsequences of $\{s_n\}_n$ and $\{t_n\}_n$ such that their elements alternate in the following way: $s_1 < t_1 < s_2 < t_2 \dots$. Then, $\gamma|_{[s_n, s_{n+1}]}$ is a causal curve with endpoints in U which, due to $\gamma(t_n) \notin U$, intersects U in a disconnected set. This contradicts that (\bar{V}, g) is strongly causal at $p \in \bar{V}$. \square

Remark 3.8. (a) Causally convex neighbourhoods play a similiar role as globally hyperbolic ones in spacetimes without boundary [77, Thm. 2.14]. Indeed, the proof of Prop. 3.7 also shows that any $p \in \bar{V}$ admits a neighbourhood W which is intrinsically causally convex (that is, $(U, g|_U)$ is a causally convex spacetime).

(b) As in the case without boundary if \bar{V} is either past or future distinguishing, then, it is causal (otherwise, choosing $p \neq q$ in a closed causal curve one would have $p \leq q$, $q \leq p$ and both $I^+(p) = I^+(q)$, $I^-(p) = I^-(q)$ would follow by applying the transitivity relations in Prop. 3.5), consistently with the ordering of the causal ladder.

Following the ladder, (\bar{V}, g) is *stably causal*, when there exists a *time function*, i.e., a continuous function τ which increases strictly on all future-directed causal curves.

Remark 3.9. (a) In the case without boundary, the existence of a time function becomes equivalent to the more restrictive existence of a *temporal* one, i.e., a smooth function with timelike past-directed gradient. The proof in [91, Section 6.3] (which uses the procedure for the construction of time functions in [14]) can be extended directly to the case with boundary, because no restriction on $\nabla\tau$ is necessary now. Indeed, such a proof would allow to extend directly the temporal function to an extension of the metric in \bar{V}^d , so, proving that any stably causal spacetime with boundary can be regarded as a closed subset of a stably causal spacetime without boundary of the same dimension.

(b) Easily, the existence of a time function implies strong causality. In fact, if we consider two open neighbourhoods U_1, U_2 of $p \in \bar{V}$, such that $\bar{U}_1 \subset U_2$, then the time function along any

causal curve departing from p , getting out of U_1 and arriving to U_2 , presents a growth greater than certain $\epsilon > 0$, and so, the curve cannot return to U_1 . This completes the ordering of the lower levels in the causal ladder.

The higher levels of the ladder (related to Geroch's proof of the splitting) will be revisited in the next section. Its definitions (as optimized in [16, 77] for the case without boundary) are the following.

Definition 3.10. *A spacetime with timelike boundary (\bar{V}, \mathfrak{g}) is:*

- causally continuous, *when the set valued functions $I^\pm : \bar{V} \rightarrow P(\bar{V})$ are both, one to one (that is, the spacetime is distinguishing) and continuous (for the natural topology in $P(\bar{V})$ which admits as a basis the sets $\{U_K : K \subset \bar{V} \text{ is compact}\}$, where $U_K = \{A \subset \bar{V} : A \cap K = \emptyset\}$, see [77, Def. 3.37 to Prop. 3.38]);*
- causally simple, *when it is causal and the subsets $J^\pm(p)$ are closed for all $p \in \bar{V}$;*
- globally hyperbolic, *when it is causal and the subsets $J^+(p) \cap J^-(q)$ are compact for all $p, q \in \bar{V}$.*

3.1.3 Continuous vs H^1 -causal curves

Even though the basic definitions in Lorentzian Geometry are carried out with smooth elements (in particular, causal curves are regarded as piecewise smooth), *continuous causal* curves are required for relevant purposes. Indeed, a key result is the *limit curve theorem* [11, Prop. 3.31] which, under some hypotheses, ensures the existence of a limit curve to a sequence of causal ones, being the limit only continuous causal (even if the causal curves in the sequence are smooth). In the case of distinguishing spacetimes without boundary, a continuous future-directed causal curve $\gamma : I \subset \mathbb{R} \rightarrow V$ is any continuous curve that preserves the causal relation, that is, satisfying: $t, t' \in I$ and $t < t'$ implies² $\gamma(t) < \gamma(t')$, see [77, Prop. 3.19]; for non-distinguishing spacetimes, this property is required to be satisfied locally in arbitrarily small neighbourhoods, see [77, Sect. 3.5]. Continuous causal curves are known to satisfy a locally Lipschitz condition.

In the context of (strongly causal) spacetimes with timelike boundary the following extended notion of continuous causal curve was introduced in Solis' Ph.D. Thesis, see [95, Def. 3.19]:

Definition 3.11. *A continuous curve $\gamma : I \rightarrow \bar{V}$ on a strongly causal spacetime with timelike boundary (\bar{V}, \mathfrak{g}) is said to be future-directed timelike if for any $t_0 \in I$ there exists a \tilde{V} -convex neighbourhood U_0 around $\gamma(t_0)$ (where $(\tilde{V}, \tilde{\mathfrak{g}})$ is a spacetime without boundary that extends (\bar{V}, \mathfrak{g}) , see Prop. 3.1) and an interval $[a, b] \subset I$ such that for all $s, t \in [a, b]$ with $s \leq t_0 \leq t$, one has $\gamma(s) \in I^+(\gamma(t), U_0 \cap \bar{V})$.*

Then, the author shows that this definition does not depend on the extended spacetime $(\tilde{V}, \tilde{\mathfrak{g}})$. Thus, causality relations in (\bar{V}, \mathfrak{g}) defined by using continuous curves as in the previous definition are equivalent to the classical ones with piecewise smooth ones, see [95, Remarks 3.20 and 3.21]. However, in the proof of [95, Lemma 3.23] (limit curve theorem for spacetimes with timelike boundary), it is not clear that the limit curve is continuous causal with the previous definition. So, we will circumvent this problem by introducing a type of continuous causal

²Here, $<$ denotes the strict causal relation, i.e., the existence of a (piecewise smooth) future-directed causal curve (thus, with non-vanishing velocity) starting at $\gamma(t)$ and ending at $\gamma(t')$; recall that the non-strict causal relation $p \leq q \Leftrightarrow p < q$ or $p = q$ defines de causal future.

curves satisfying: (a) it is also equivalent to the concept of continuous causal in manifolds without boundary, (b) it does not require to use extensions, and (c) it is preserved for limit curves as in the case without boundary. Anyway, the circumvented problem is postponed for future research.

In order to introduce these curves, let us recall first some basic definitions and results. We begin by recalling the following result that characterizes absolutely continuous curves in \mathbb{R}^n , see [74, Thm. 2.7.2].

Theorem 3.12. *If $\gamma : I = [a, b] \rightarrow \mathbb{R}^n$ is a measurable curve, then the following statements are equivalent:*

- $\gamma : I \rightarrow \mathbb{R}^n$ is absolutely continuous, i.e. for any $\epsilon > 0$ there exists $\delta > 0$ such that, for any partition $\{a \leq t_0 \leq \dots \leq t_{2k+1} \leq b\}$, with $\sum_{i=1}^k |t_{2i+1} - t_{2i}| < \delta$, we have $\sum_{i=1}^k |\gamma(t_{2i+1}) - \gamma(t_{2i})| < \epsilon$;
- γ is differentiable almost everywhere in I , the derivative $\gamma' \in L^1(I, \mathbb{R}^n)$, and the fundamental theorem of integral calculus holds, i.e.

$$x(t) = x(0) + \int_0^t \gamma'(s) ds \quad \text{for any } t \in I.$$

Now, we are in conditions to define the classical Sobolev space $H^1(I, \mathbb{R}^n)$:

$$H^1(I, \mathbb{R}^n) := \{\gamma : I \rightarrow \mathbb{R}^n \text{ absolutely continuous such that } \gamma' \in L^1(I, \mathbb{R}^n)\}.$$

This space can be extended to a smooth manifold V and any interval I as follows:

Definition 3.13. *Let V be a smooth n -manifold and I any interval. A continuous curve $\gamma : I \rightarrow V$ is a H^1 -curve if for any local chart (U, φ) with $\gamma(I) \cap U \neq \emptyset$ we have that $\varphi \circ \gamma|_I$ belongs to the Sobolev space $H^1(I', \mathbb{R}^n)$ for all compact subsets I' of $\gamma^{-1}(U)$. The space of H^1 -curves from I to V will be denoted by $H^1(I, V)$*

In the case that I is compact, $H^1(I, V)$ can be rewritten as

$$H^1(I, V) = \{\gamma : I \rightarrow V \text{ absolutely continuous} \mid \int_a^b h(\gamma'(s), \gamma'(s)) ds < +\infty\},$$

being h some/any Riemannian metric on V and absolute continuity defined with respect to the distance associated with h . In fact, the finite integral condition written above is independent of the choice of the Riemannian metric h on V because of the compactness of I . In the case that I is not a compact interval, γ is H^1 when so is its restriction to any compact subinterval (again, this is independent of the chosen h).

The following relation between causal continuous and causal H^1 -curves was carried out in³ [19, Appendix A].

Proposition 3.14. *Let (V, g) be a spacetime (without boundary) and $\gamma : [a, b] \rightarrow V$ continuous. The curve γ is future-directed continuous causal if and only if γ is H^1 , up to a reparametrization, and $\gamma'(s)$ is a future-directed causal vector almost everywhere in I .*

From the proof it is also clear that the reparametrization can be always carried out locally by using any temporal function (in this case, γ can be regarded as a Lipschitz function).

In order to extend the notion of continuous causal curve to a spacetime with timelike boundary, we will use the previous property. But, first, we need to define the notion of H^1 -causal curve in the context of a spacetime with timelike boundary. So, let (\bar{V}, g) be a spacetime with timelike boundary and fix some complete Riemannian metric h on it.

³Here, the motivation was the application of variational methods in the infinite dimensional space of causal curves joining two prescribed points.

Definition 3.15. A continuous curve $\gamma : [a, b] \rightarrow \bar{V}$ is future-directed (resp. past-directed) H^1 -causal if it is H^1 (in the sense above) and $\gamma'(s)$ is a future-directed (resp. past-directed) causal vector for $s \in I$ a.e. An inextensible future-directed (resp. past-directed) H^1 -causal curve $\gamma : (a, b) \rightarrow \bar{V}$ ($-\infty \leq a < b \leq +\infty$) is an H^1 -curve that cannot be extended continuously to b (resp. a) and $\gamma'(s)$ is a future-directed (resp. past-directed) causal vector a.e.

Notice that for H^1 -causal curves the reparametrization is chosen directly H^1 (again, this can be carried out locally by means of temporal functions, see footnote 7).

The classical theorem of limit curves is also valid in the context of spacetimes with timelike boundary and H^1 -causal curves, see [11, Prop. 3.31] and [95, Lemma 3.23].

Proposition 3.16. Let (\bar{V}, \mathfrak{g}) be a spacetime with timelike boundary and $\{\gamma_m\}_m$ a sequence of future inextensible H^1 -causal curves. If $p \in \bar{V}$ is an accumulation point, then, there exists a limit curve γ of $\{\gamma_m\}_m$ which is a future inextensible H^1 -causal curve and with $p \in \gamma$.

Proof. Using Prop. 3.1, (\bar{V}, \mathfrak{g}) can be regarded as a subset of a spacetime without boundary $(\tilde{V}, \tilde{\mathfrak{g}})$. Then, by the limit curve theorem in $(\tilde{V}, \tilde{\mathfrak{g}})$ (see [11, Prop. 3.31]) there exists an inextensible limit curve γ in \tilde{V} , which is included in \bar{V} (as \bar{V} is closed in \tilde{V}). Moreover, γ is continuous causal in \tilde{V} and, thus, can be parametrized as H^1 -causal in \tilde{V} (and \bar{V}), by Prop. 3.14. \square

Denote by $J^+(p)_{H^1}$ (resp. $J^-(p)_{H^1}$) the causal future (resp. causal past) of $p \in \bar{V}$ computed by using future-directed (resp. past-directed) H^1 -causal curves. Clearly, $J^\pm(p) \subset J^\pm(p)_{H^1}$, but it is not clear if the other contention holds. This will be studied in Subsection 3.3, after developing some local properties of the boundary.

3.2 The topological splitting

3.2.1 Higher steps of the causal ladder.

Geroch's proof of the topological splitting of globally hyperbolic spacetimes (without boundary) (V, \mathfrak{g}) is based in the existence of certain time function constructed by computing volumes of suitable subsets by using a certain measure m . The conditions to be satisfied by m are very mild; indeed, they are satisfied by the measure associated to any semi-Riemannian metric \mathfrak{g}^* such that the total volume of the manifold is finite (so, one can choose \mathfrak{g}^* conformal to the original Lorentzian metric \mathfrak{g}). However, following Dieckmann ([28]; see also [77, section 3.7]) the abstract required properties for a measure on \bar{V} will be studied first.

Given the spacetime with boundary (\bar{V}, \mathfrak{g}) , $\bar{V} = V \cup \partial V$, consider the σ -algebra $\mathfrak{A}(\tau_{\bar{V}} \cup \bar{Z})$ generated by the topology $\tau_{\bar{V}}$ of \bar{V} in addition to the set \bar{Z} containing the zero-measure sets of \bar{V} . Since V is an open subset of \bar{V} , the σ -algebra $\mathfrak{A}(\tau_V \cup Z)$ of V contains and, moreover, coincides with the induced σ -algebra of $\mathfrak{A}(\tau_{\bar{V}} \cup \bar{Z})$ over V , that is, with the set $\{E \cap V \mid E \in \mathfrak{A}(\tau_{\bar{V}} \cup \bar{Z})\}$ (see for example [84, Lemma 3.2.1]). In a natural way, the measures on the previous σ -algebras will be called just measures on \bar{V} or V , consistently.

Definition 3.17. A measure \bar{m} on \bar{V} is admissible when it satisfies:

1. $\bar{m}(\bar{V}) < \infty$;
2. $\bar{m}(U) > 0$ for any open subset $U \subset \bar{V}$;
3. $\bar{m}(\dot{I}^\pm(p)) = 0$ (where $\dot{I}^\pm(p)$ is the topological boundary of $I^\pm(p)$) for all $p \in \bar{V}$;

4. for any open subset $U \subset \bar{V}$ there exists a sequence $\{K_n\}_n \subset \bar{V}$ of compact subsets such that $K_n \subset K_{n+1}$, $K_n \subset U$ for all n and $\bar{m}(U) = \lim_n \bar{m}(K_n)$.

It is straightforward to check that if m is a measure on V then it induces naturally a measure \bar{m} on \bar{V} just imposing $\bar{m}(\partial V) = 0$, that is,

$$\bar{m}(A) := m(A \cap V) \quad \text{for any } A \in \mathfrak{A}(\tau_{\bar{V}} \cup \bar{Z}).$$

Proposition 3.18. *If m is an admissible measure on V then the induced measure \bar{m} on \bar{V} is also admissible.*

Proof. Properties 1, 2, 4 of Def. 3.17 are straightforward. So, let us prove just $\bar{m}(\dot{I}^-(p)) = 0$ or, equally, $m(\dot{I}^-(p) \cap V) = 0$. Let $\gamma_p : [0, 1] \rightarrow \bar{V}$ be any future-directed timelike curve with $\gamma([0, 1]) \subset V$ and⁴ $\gamma(1) = p \in \bar{V}$. It is enough to prove

$$\dot{I}^-(p) \cap V \subset \partial_V I^-(\gamma_p, V), \quad (3.2)$$

where $\partial_V I^\pm(p, V)$ denotes the (topological) boundary of $I^\pm(p, V)$ computed in V , since in that case, $\partial_V I^-(\gamma_p, V)$ is an achronal, edgeless subset of V , and thus, it is a C^0 -hypersurface of V which is written locally as the graph of a locally Lipschitz function⁵, and so, $m(\partial_V I^-(\gamma_p, V)) = 0$. To prove (3.2), just let us check that, for any $q \in \dot{I}^-(p) \cap V$ and any open neighbourhood $U \subset V$ of q :

$$U \cap I^-(\gamma_p, V) \neq \emptyset \quad \text{and} \quad U \cap (V \setminus I^-(\gamma_p, V)) \neq \emptyset. \quad (3.3)$$

Any $u \in I^-(q, U)$ proves the first relation, because there exists some $q' \in I^+(u, U) \cap I^-(p)$ and, thus, $p \in I^+(u)$, which implies $\gamma(s) \in I^+(u)$ for s close to 1. For the second one, recall that $q \in \dot{I}^-(p) \cap M$ implies $I^+(q) \subset \bar{V} \setminus cl(I^-(p))$; thus, any $w \in I^+(q, U)$ will satisfy the stronger property $w \in V \setminus cl(I^-(\gamma_p, V))$. In fact, if $w \in cl(I^-(\gamma_p, V))$ then there would exist a sequences in V , $\{w_i\} \rightarrow w$ and $\{\gamma_p(s_i)\}$ satisfying $w_i \ll \gamma_p(s_i) \ll p$, and thus, $w \in cl(I^-(p))$, in contradiction with the fact that $w \in \bar{V} \setminus cl(I^-(p))$. \square

Remark 3.19. An alternative way to define an admissible measure \bar{m} on \bar{V} can be developed by using Prop. 3.1. In fact, if (\tilde{V}, \tilde{g}) (a spacetime without boundary) is an extension of (\bar{V}, g) , consider an admissible measure m_0 on (\tilde{V}, \tilde{g}) (see [77, Section 3.7]), and take the restriction of m_0 over \bar{V} , which provides an admissible measure on \bar{V} .

In what follows, an admissible measure \bar{m} is fixed on \bar{V} .

Definition 3.20. *The function $t^-(p) := \bar{m}(I^-(p))$ (resp. $t^+(p) := -\bar{m}(I^+(p))$) is the past (resp. future) volume function associated to \bar{m} .*

Trivially, the volume functions are non-decreasing on any future-directed causal, but they are constant on any closed causal curve.

Proposition 3.21. *If (\bar{V}, g) is past (resp. future) distinguishing, the volume function t^- (resp. t^+) is strictly increasing over any future-directed causal curve γ .*

⁴Such a curve admits a natural interpretation by looking any $p \in \partial V$ as a point of the causal boundary (recall [35, Sect. 4]).

⁵This is a well-known fact, see [43, Prop. 3.1, 3.3] and the proof of [83, Prop. 14.25]. However, for the sake of completeness, we reproduce the argument for manifolds with boundary, including the Lipschitz property in Prop. 3.31.

Proof. Arguing for t^- , since (\bar{V}, g) is past-distinguishing there are no closed causal curves in (\bar{V}, g) (Remark 3.8(b)). So, if $p = \gamma(t)$, $q = \gamma(t')$ with $t < t'$ then necessarily $p \neq q$, $I^-(p) \subset I^-(q)$ and $t^-(p) \leq t^-(q)$. Assume $t^-(p) = t^-(q)$ to obtain a contradiction with $I^-(p) \subsetneq I^-(q)$. That equality implies, for any non-empty open subset $U \subset I^-(q)$, that $U \cap I^-(p) \neq \emptyset$. So, for any $w \in I^-(q)$ there exists some $z \in U := I^+(w) \cap I^-(q)$ and $w \ll z \ll q$, i.e., $w \in I^-(p)$. \square

The following proposition characterizes when t^\pm is continuous. Their proofs are totally analogous to the case without boundary because, on the one hand, the property $\bar{m}(\partial V) = 0$ makes ∂V irrelevant for the computation of t^\pm and, on the other, the timelike character of ∂V ensures that, for any $\hat{r} \in \partial V$, there are arbitrarily close points (in V as well as in ∂V) p_m, q_m , such that $\hat{r} \in I^+(p_m) \cap I^-(q_m)$.

Proposition 3.22. *For any spacetime with timelike boundary (\bar{V}, g) the following properties are equivalent:*

1. *The set valued function I^+ (resp. I^-) is continuous on \bar{V} .*
2. *The volume function t^+ (resp. t^-) is continuous on \bar{V} .*
3. *(\bar{V}, g) is past (resp. future) reflecting, that is, for all $p, q \in \bar{V}$:*
 $q \in cl(I^+(p)) \Rightarrow p \in cl(I^-(q))$ (resp. $p \in cl(I^-(q)) \Rightarrow q \in cl(I^+(p))$).

So, a distinguishing spacetime is causally continuous if and only if all the previous equivalent properties hold and, thus, if and only if both volume functions t^+, t^- are time functions.

Proof. As explained above, the proof is completely analogous to the case without boundary, studied in detail in [77]. The involved results of this reference are: characterizations of the continuity of I^\pm , Defn. 3.37 and Prop. 3.38; equivalence continuity I^\pm / continuity t^\pm , Prop. 3.41 (essentially equivalent to Lemmas 3.39, 3.40); equivalence continuity I^\pm / reflectivity, Prop. 3.47 (essentially equivalent to Lemma 3.46). Alternative definitions of reflectivity appear in Lemma 3.42, but they will not be required here. \square

The following result will allow to complete the implications of the ladder, taking into account the optimized definitions of global hyperbolicity and causal simplicity used here (consistent with [16]).

Lemma 3.23. *Let (\bar{V}, g) be a spacetime with timelike boundary.*

- (a) *If it is causally simple then it is causally continuous.*
- (b) *If it is globally hyperbolic then it is causally simple.*

Proof. (a) We have to prove that it is both, distinguishing and (by Prop. 3.22) (future and past) reflecting. For the former, following [16], if $p \neq q$ but, say, $I^+(p) = I^+(q)$ then choose any sequence $\{q_n\} \rightarrow q$ with $q \ll q_n$ and, thus, $p \ll q_n$. Then $q \in cl(I^+(p)) = cl(J^+(p)) = J^+(p)$ (the first equality by Prop. 3.5 and the second by hypothesis). Analogously, $p \in J^+(q)$ and there is a closed causal curve with endpoints at p crossing q . For the latter property, causal simplicity implies $J^\pm(p) = cl(I^\pm(p))$ and, thus, the reflectivity becomes equivalent to the trivially true property $q \in J^+(p) \Leftrightarrow p \in J^-(q)$.

(b) Following [95, Props. 3.16, 3.17]), let us check that, say, $J^+(p)$ is closed. Let $r \in cl(J^+(p))$, so, $r = \lim_m r_m$ with $r_m \in J^+(p)$. Since ∂V is timelike there are no isolated points, so, there exists some $q \in I^+(r)$ and $r_m \in I^-(q)$ for large m . Then, $r \in cl(J^+(p) \cap J^-(q)) = J^+(p) \cap J^-(q)$ (the latter by global hyperbolicity) and $p \in J^+(p)$, as required. \square

Theorem 3.24. *Let (\bar{V}, g) be a spacetime with timelike boundary.*

1. If (\bar{V}, \mathfrak{g}) is causally continuous then it is stably causal. Moreover, $(V, \mathfrak{g}|_V)$ is causally continuous and $(\partial V, \mathfrak{g}|_{\partial V})$ is stably causal.
2. If (\bar{V}, \mathfrak{g}) is causally simple then it is causally continuous.
3. If (\bar{V}, \mathfrak{g}) is globally hyperbolic then it is causally simple. Moreover, $(\partial V, \mathfrak{g}|_{\partial V})$ is globally hyperbolic too.

Proof. 1. The first assertion follows just because any of the volume functions t^+, t^- provides the required time function (recall Prop. 3.22). Moreover, ∂V is also stably causal because, trivially, the restrictions of these functions to ∂V are also time functions. The causal continuity of the interior V is again a consequence of Prop. 3.22 taking into account that t^\pm are both continuous on all \bar{V} and their restrictions on V agree with the volume functions for the measure m on V . Indeed, as $I^\pm(p, V) = I^\pm(p) \cap V$ (Prop. 3.5), $m(I^\pm(p, V)) = \bar{m}(I^\pm(p))$ for all $p \in V$ and the result follows.

2. This is just Lemma 3.23 (a).

3. The first assertion is just Lemma 3.23 (b). The last assertion was proved in [95, Prop. 3.15], we include the proof for completeness (in particular, this makes apparent that no harm was introduced by the weakening of strong causality into causality in the definition of global hyperbolicity). As ∂V is strongly causal, it is enough to check that $cl(J^+(p, \partial V) \cap J^-(q, \partial V))$ is compact (see [11, Lemma 4.29]). Now, any sequence in this subset admits a subsequence converging to some $r \in J^+(p) \cap J^-(q)$ and, as ∂V is closed in \bar{V} , $r \in cl(J^+(p, \partial V) \cap J^-(q, \partial V))$. \square

Remark 3.25. Thm. 3.24 (with Remark 3.8(b)) allows to reobtain the strict ordering of all the steps in the classical causal ladder of spacetimes for the case of spacetimes with timelike boundary. The following examples show, in particular, that the inherited properties for V and ∂V are optimal.

(1) Start with the closed half space of Lorentz-Minkowski 3-space $\{(t, x, y) \in \mathbb{L}^3 : y \geq 0\}$ and remove the line $L = \{(0, 0, x) \mid x \geq 0\}$. The obtained spacetime \bar{V} is causally continuous (as so is V and the continuous extension of the V -volume functions to \bar{V} agree with the volume functions on \bar{V}) but, clearly, ∂V is not.

(2) Consider now $\bar{V} = \mathbb{L}^3 \setminus C$, where C is the timelike cylinder $\mathbb{R} \times D$, being D the disk $\{x^2 + y^2 < 1\} \subset \mathbb{R}^2$. Clearly, $J^+(p, V)$ is not closed whenever there exists a future-directed lightlike half-line l starting at $p \in V$ and tangent to ∂V at some point $\hat{q} \in \partial V$; indeed, the points in l beyond \hat{q} will lie in $cl(J^+(p, V)) \setminus J^+(p, V)$. That is, in general V is not causally simple, even if \bar{V} is globally hyperbolic.

(3) Finally, consider the closure of the previous cylinder, $\bar{C} = \mathbb{R} \times \bar{D} \subset \mathbb{L}^3$, take the arc $A = \{(0, \cos \theta, \sin \theta) : 0 \leq \theta \leq \pi/4\}$ and consider the spacetime $\bar{V} = \bar{C} \setminus A$. Clearly, ∂V is not causally continuous. However, \bar{V} (and also V) is causally simple. Indeed, for each $p \in V$, it is obvious not only that $J^\pm(p, V)$ is closed for $p \in V$ but also that so is $J^\pm(p)$. This happens even if $p \in \partial V$ because any $q (\neq p)$ in the boundary of $J^\pm(p)$ can be joined with p by means of a lightlike segment included in V up to the endpoints⁶.

3.2.2 Extended Geroch's proof.

Formally, our notion of Cauchy hypersurface for a spacetime with timelike boundary is equal to the minimal one developed in [83] for the case without boundary.

Definition 3.26. Let (\bar{V}, \mathfrak{g}) be a spacetime with timelike boundary. An achronal set $\bar{\Sigma} \subset \bar{V}$ is a Cauchy hypersurface if it is intersected exactly once by every inextensible timelike curve.

⁶From a more general viewpoint, this property happens because ∂V is strongly light-convex (see [20, Sect. 3.2 and Thm. 3.5] for further background and results)

We will check in the next subsection some properties of Cauchy hypersurfaces (in particular, that they are truly topological hypersurfaces with boundary) in a more general setting. Next, we focus in the existence of a Cauchy time function. Consider the *Geroch function*,

$$t: \bar{V} \rightarrow \mathbb{R}, \quad t(p) := \ln \left(-\frac{t^-(p)}{t^+(p)} \right). \quad (3.4)$$

From Thm. 3.24 and Prop. 3.22, this function is continuous for any globally hyperbolic spacetime with timelike boundary. Thus, we have the elements to extend Geroch's proof to the case with boundary, see [77, Lemma 3.76].

Theorem 3.27. *For any globally hyperbolic spacetime with timelike boundary (\bar{V}, \mathfrak{g}) , Geroch's function t defined in (3.4) is a Cauchy time function, that is, t is a time function and all its levels are Cauchy hypersurfaces.*

Proof. As t is a time function (the sum of the time functions $\ln t^-$ and $\ln(-t^+)$), it is enough to check, that, for any inextensible future-directed causal curve $\gamma: (a, b) \rightarrow \bar{V}$,

$$\lim_{s \rightarrow a} t^-(\gamma(s)) = 0, \quad (\text{and analogously } \lim_{s \rightarrow b} t^+(\gamma(s)) = 0),$$

so that $\lim_{s \rightarrow a} t(\gamma(s)) = -\infty$ and $\lim_{s \rightarrow b} t(\gamma(s)) = \infty$ (as in the case without boundary). To check $\lim_{s \rightarrow a} t^-(\gamma(s)) = 0$, recall that the measure of \bar{V} can be approximated by compact subsets (Prop. 3.18). So, for any $\epsilon > 0$ there exists some compact $K \subset \bar{V}$ with $\bar{m}(\bar{V} \setminus K) < \epsilon$ and one has just to show that there exists $s_0 \in (a, b)$ such that $I^-(\gamma(s_0)) \cap K = \emptyset$ (as this implies $t^-(\gamma(s)) = \bar{m}(I^-(\gamma(s))) \leq \bar{m}(\bar{V}) - m(K) < \epsilon$, for all $s \leq s_0$). Assuming by contradiction the existence of a sequence $\{s_m\} \rightarrow a$ with $I^-(\gamma(s_m)) \cap K \neq \emptyset$ for all m , there exists a sequence $\{r_m\}_m \subset K$ with $r_m \in I^-(\gamma(s_m))$; by the compactness of K , $\{r_m\} \rightarrow r \in K$ up to a subsequence. Taking $p \in I^-(r)$ and some fixed $q = \gamma(c)$, one has $p \ll r_m \ll \gamma(s_m) \ll q$ for large m . This implies $\gamma(a, c] \subset J^+(p) \cap J^-(q)$, that is, a past inextensible causal curve is imprisoned in the compact subset $J^+(p) \cap J^-(q)$, which contradicts Prop. 3.7 (b). \square

3.2.3 Hypersurfaces with boundary, achronal sets and edges

Definition 3.28. *The edge of an achronal set $A \subset \bar{V}$ is formed by the points $p \in cl(A)$ ($cl(\cdot)$ denotes the topological closure) such that, for every open neighbourhood $U \subset \bar{V}$ of p , there exists a timelike curve contained in U from $I^-(p, U)$ to $I^+(p, U)$ that does not intersect A .*

For any topological hypersurface $\bar{S} = S \cup \partial S$ we will assume that it is embedded; however it may not be closed (so, ∂S denotes only its boundary as a submanifold with boundary). Our study follows [83, Ch. 14], taking into account the following technicality.

Lemma 3.29. *If \bar{S} is an achronal embedded topological hypersurface with boundary and ∂S is included in ∂V , then $\bar{S} \cap edge(\bar{S}) \cap \partial V = \emptyset$.*

Proof. For points in $S = \bar{S} \setminus \partial S$, the result follows as in the case without boundary and we can assume $\partial S = \bar{S} \cap \partial V$. Consider a Gaussian chart $(U, \psi = (x^0, \dots, x^{n-1}))$ centered at some $\hat{p} \in \partial S$ so that $\psi(U)$ is the cube $L \times [0, \epsilon) \subset \mathbb{R}^{n-1} \times \mathbb{R}_+$, $L := (-\epsilon, \epsilon)^{n-1}$ with origin at $\psi(\hat{p})$. Notice that $\partial S \subset \partial V$ must be an achronal topological hypersurface (without boundary) of ∂V . As ∂_0 is timelike then its integral curve at \hat{p} is transversal to ∂S and does not intersect \bar{S} elsewhere, by continuity, its integral curves close to \hat{p} satisfy these properties too. Thus, reducing the coordinate cube if necessary, we can assume that ∂S and an achronal embedded topological $(n-2)$ -submanifold (without boundary) in L , which can be written as a continuous graph on $x^0 = 0 = x^{n-1}$ around \hat{p} . Such a graph can be extended locally to some N included in $x^0 = 0$

by writing $\psi(U) = (-\epsilon, \epsilon) \times N$ (reducing if necessary U by taking a smaller ϵ), and taking into account that the projection $\pi : \psi(U \cap \bar{S}) \rightarrow N$ is continuous, one to one and onto. So, taking π^{-1} and projecting on the $(-\epsilon, \epsilon)$ part, one obtains a function $h : N \rightarrow (-\epsilon, \epsilon)$, whose graph $\{(h(x), x) : x \in N\}$ coincides with $\psi(U \cap \bar{S})$. As h is continuous (because of the continuity of \bar{S} as a topological hypersurface) the graph separates U in two open subsets, one of them containing $I^+(\hat{p}, U)$ and the other $I^-(\hat{p}, U)$ (recall that x^0 increases on timelike curves). So, any curve (timelike or not) in U from $I^-(\hat{p}, U)$ to $I^+(\hat{p}, U)$ must cross \bar{S} , and $\hat{p} \notin \text{edge}(\bar{S})$. \square

Remark 3.30. To check the role of the hypotheses, let $\bar{V} = \{(t, x, y) \in \mathbb{L}^3 : y \geq 0\}$. The achronal closed disk $A = \{(0, x, y) \in \mathbb{L}^3 : (x-1)^2 + y^2 \leq 1\}$ contains the edge point $(0, 0, 0) \in \partial A$, showing the necessity of the assumption $\partial A \subset \partial V$. However, such an assumption permits $\text{edge}(A) \cap \partial V \neq \emptyset$ (take $A = \{(0, x, y) \in \bar{V} : (x, y) \neq (0, 0)\}$). In any case, the intersection $\partial V \cap A$ must be transverse (and any point in this intersection also belongs to ∂A), according to the proof Lemma 3.29.

In the case that $\partial V = \emptyset$, and A is allowed to have a boundary, then $A \cap \text{edge}(A)$ is precisely the set of the points of the boundary ∂A of A , but we will not be interested in this possibility.

Next, the result for the case without boundary in [83, Prop. 14.25] is generalized.

Proposition 3.31. *Let (\bar{V}, \mathfrak{g}) , $\bar{V} = V \cup \partial V$, be a spacetime with timelike boundary. An achronal set A is an embedded, topological (necessarily, locally Lipschitz) hypersurface with boundary included in ∂V (i.e., with $\partial A = A \cap \partial V$) if and only if $A \cap \text{edge}(A) = \emptyset$.*

Proof. For the implication to the right, $A \cap V$ must be an achronal topological hypersurface (without boundary) in (V, \mathfrak{g}) . Then, $(A \cap \text{edge}(A)) \cap V = \emptyset$ follows from [83, Prop. 14.25] and $(A \cap \text{edge}(A)) \cap \partial V = \emptyset$ from Lemma 3.29.

For the implication to the left, assume that $A \cap \text{edge}(A) = \emptyset$. Clearly, this implies that the achronal set $A \cap V$ has no edge points and (again from [83, Prop. 14.25]) $A \cap V$ is a topological hypersurface without boundary in (V, \mathfrak{g}) . So, let $\hat{p} \in A \cap \partial V \neq \emptyset$. Our aim will be to construct a locally Lipschitz topological chart (U_0, ϕ) centered at $\hat{p} \in U_0 \subset \bar{V}$ such that $\phi(U_0 \cap A)$ is $(\{0\} \times \mathbb{R}_+^{n-1}) \cap \phi(U_0)$.

Since $A \cap \text{edge}(A) = \emptyset$, there exists some open neighbourhood U of \hat{p} such that any timelike curve contained in U going from $I^-(\hat{p}, U)$ to $I^+(\hat{p}, U)$ intersects A . Without loss of generality, we can assume that $(U, \psi = (x^0, \dots, x^{n-1}))$ is a Gaussian chart centered at \hat{p} such that $\psi(U)$ is the cube $L \times [0, \epsilon) \subset \mathbb{R}^{n-1} \times \mathbb{R}_+$, with $L = (-\epsilon, \epsilon)^{n-1}$. Consider the subset $(-\epsilon, \epsilon) \times N_U \subset \psi(U) \subset \mathbb{R} \times \mathbb{R}_+^{n-1} = \mathbb{R}_+^n$, where $N_U \subset \mathbb{R}_+^{n-1}$ contains the points of $\psi(U)$ with $x^0 = 0$. The required neighbourhood $U_0 \ni \hat{p}$ will be $U_0 = \psi^{-1}((-\epsilon, \epsilon) \times N)$, where $N \subset N_U$ is any (half) ball centered at 0 for the natural Euclidean metric $|\cdot|$ in the coordinates $\hat{x} := (x^1, \dots, x^{n-1})$, with small radius so that N is relatively compact in N_U and the slices $x^0 = \pm\epsilon/2$ satisfy:

$$\{q \in U : x^0(q) = -\epsilon/2\} \subset I^-(\hat{p}, U) \quad \text{and} \quad \{q \in U : x^0(q) = \epsilon/2\} \subset I^+(\hat{p}, U)$$

(this can be achieved trivially because ∂_0 is timelike). Now, the integral curve of ∂_0 starting at any $y \in \{0\} \times N$ must intersect both, $I^-(\hat{p}, U)$ and $I^+(\hat{p}, U)$. Thus, it must intersect A (as the choice of $U \supset U_0$ used $\hat{p} \notin \text{edge}(A)$) in a point y_q , which is unique by the achronality of A . So, $A \cap U_0$ can be regarded as the graph of the function $h : N \rightarrow (-\epsilon, \epsilon)$, $h(q) := x^0(y_q)$. To show that h is Lipschitzian will be enough because, in this case, the desired chart ϕ on U_0 is just:

$$\phi(\psi^{-1}(x^0, \dots, x^{n-1})) = (x^0 - h(x^1, \dots, x^{n-1}), x^2, \dots, x^{n-1})$$

(clearly then, $\phi(A \cap U_0)$ is the zero slice of $\phi(U_0) \subset \mathbb{R} \times \mathbb{R}_+^{n-1}$).

The Lipschitz condition will be also checked with respect to $|\cdot|$ in U_0 . Recall first that, as $\text{cl}(U_0)$ is compact and ∂_0 is timelike, there exists some small $c > 0$ such that the cones of the flat

Lorentzian metric $g_c = -c^2(dx^0)^2 + \sum_{i=1}^{n-1}(dx^i)^2$ satisfy $g_c < g$. The Lipschitz condition $|h(x) - h(y)| < c^{-1}|x - y|$ holds for all $x, y \in N$ because, otherwise, the points $(h(x), x), (h(y), y)$ would be (future or past) causally related for g_c and, thus, for g (in contradiction with the achronality of A). \square

As a consequence, some natural properties of achronal and Cauchy hypersurfaces are extended to spacetimes with timelike boundary.

Corollary 3.32. (1) *An achronal set A is a closed (embedded) topological hypersurface with boundary included in ∂V if and only if $edge(A) = \emptyset$.*

(2) *Let $F \neq \emptyset, \bar{V}$ be a future set (i.e. $I^+(F) \subset F$). Then, its topological boundary ∂F is an achronal closed locally Lipschitz topological hypersurface with boundary included in ∂V .*

(3) *Any Cauchy hypersurface $\bar{\Sigma}$ of (\bar{V}, g) is an achronal closed locally Lipschitzian topological hypersurface with boundary included in ∂V .*

Proof. (1) For (\Rightarrow) , always $edge(A) \subset cl(A)$ and, as A is closed, now $edge(A) \subset A$. So, just notice $A \cap edge(A) = \emptyset$ from Prop. 3.31. For (\Leftarrow) , Prop. 3.31 yields that A is a topological hypersurface with boundary included in ∂V . Closedness follows directly from the general inclusion $cl(A) \setminus A \subset edge(A)$, which happens because, if $q \in cl(A) \setminus A$, no timelike curve through q can intersect A (A achronal implies $cl(A)$ achronal, as the chronological relation is also open in the case with boundary) and, so, $q \in edge(A)$.

(2) Taking into account elementary properties of transitivity (Prop. 3.5),

$$I^+(\partial F) \subset \text{interior}(F), \quad I^-(\partial F) \subset \bar{V} \setminus cl(F), \quad \text{in particular, } I^+(\partial F) \cap I^-(\partial F) = \emptyset.$$

From the last inclusion ∂F is achronal. From the part (1), to prove $edge(\partial F) = \emptyset$ suffices and, since ∂F is closed, $edge(\partial F) \subset \partial F$, that is, $edge(\partial F) \cap \partial F = \emptyset$ suffices too. Assuming $p \in edge(\partial F) \cap \partial F$, there exists a timelike curve starting at $I^-(p)$ (thus, in $\bar{V} \setminus cl(F)$) and ending at $I^+(p)$ (in $\text{interior}(F)$) without crossing ∂F , an absurd.

(3) Clearly, \bar{V} is the disjoint union $\bar{V} = I^+(\bar{\Sigma}) \cup \bar{\Sigma} \cup I^-(\bar{\Sigma})$. So, $\bar{\Sigma}$ is the boundary of the future set $F = I^+(\bar{\Sigma})$ and the part (2) applies. \square

Finally, Geroch's topological splitting is obtained.

Corollary 3.33. *Let (\bar{V}, g) be globally hyperbolic with timelike boundary, t any Cauchy time function and $\bar{\Sigma}_0 = t^{-1}(0)$. Then \bar{V} is homeomorphic to $\mathbb{R} \times \bar{\Sigma}_0$.*

Moreover, $\bar{\Sigma}_0$ is acausal and any other Cauchy hyp. $\bar{\Sigma}$ is homeomorphic to $\bar{\Sigma}_0$.

Proof. Prop. 3.4 ensures the existence of a future-directed timelike vector field $T \in \mathfrak{X}(\bar{V})$ whose restriction to ∂V is tangent to ∂V . With no loss of generality, T can be chosen unitary for some auxiliary complete Riemannian metric g_R on \bar{V} . Then, T is complete and, so, its integral curves are inextendible timelike curves in \bar{V} . From the part (a), t diverges along the integral curves of T , and each integral curve of T intersects $\bar{\Sigma}_0 = t^{-1}(0)$ at a unique point $x \in \bar{\Sigma}_0$, which will be regarded as the initial point of each integral curve γ_x of T . So, every $p \in \bar{V}$ can be written univocally as $\gamma_x(t)$ for some $x \in \bar{\Sigma}_0$ and $t \in \mathbb{R}$. Therefore, the map $\Psi : \bar{V} \rightarrow \mathbb{R} \times \bar{\Sigma}_0, p \mapsto (t, x)$ is continuous, bijective and maps boundaries into boundaries. Moreover, Ψ^{-1} is continuous. This is straightforward by using the theorem of invariance of the domain in the case without boundary because both, the domain and codomain of Ψ are manifolds. The case with boundary can be reduced to the previous one by using that Cor. 3.32 (3) not only ensures both $\bar{\Sigma}_0$ is a topological hypersurface with boundary and $\partial \bar{\Sigma}_0 \subset \partial V$. Simply, take the double manifolds $\bar{V}^d, \bar{\Sigma}_0^d$, and extend naturally Ψ to a continuous bijective map $\Psi^d : \bar{V}^d \rightarrow \mathbb{R} \times \bar{\Sigma}_0^d$.

For the last sentence, first, $\bar{\Sigma}_0$ is acausal because it is a level of a time function. Second, clearly $\Psi(\bar{\Sigma})$ can be regarded as the graph of a locally Lipschitz function $h : \bar{\Sigma}_0 \rightarrow \mathbb{R}$. So, the continuous map $\bar{\Sigma}_0 \ni x \mapsto (h(x), x) \in \Psi(\bar{\Sigma})$ is the required homeomorphism. \square

3.3 Smooth and H^1 causal futures and pasts

Retaking our discussion in subsection 3.1.3, we will prove that the causal future (and past) computed with H^1 -causal curves agrees with the one computed with piecewise smooth ones when (\bar{V}, \mathfrak{g}) is causally simple and postpone a more general result and its consequences for future work. The local result is proven first by using the expression in Cor. 3.35. Naturally, $J^+(q, U)_{H^1}$ denotes the set of points in U that can be reached from q by an future-directed H^1 -causal curve inside U .

Proposition 3.34. *Let (\bar{V}, \mathfrak{g}) be a globally hyperbolic spacetime with timelike boundary and $U = \hat{U} \times [0, s_+)$, $(x^0, \dots, x^{n-2}, x^{n-1} = s)$ any Gaussian chart for some $\hat{p}_0 \in \partial V$. Reducing $\hat{U} (\equiv U \cap \partial V =: \partial U)$ if necessary, a family of Lorentzian metrics \mathfrak{g}_α , $\alpha \in (0, 1]$ can be defined on U satisfying:*

- (1) *For each $\alpha \in (0, 1]$ there exists $s_\alpha > 0$ varying smoothly and non-decreasing with α (with $\lim_{\alpha \searrow 0} s_\alpha = 0$), such that, if $0 < \alpha < \alpha'$, then $\mathfrak{g} < \mathfrak{g}_\alpha$ on $U_\alpha := \hat{U} \times [0, s_\alpha)$ and $\mathfrak{g}_\alpha < \mathfrak{g}_{\alpha'}$ on U .*
- (2) *For any $\hat{p} \in U \cap \partial V$, the function $\tau_\alpha :=]_{\hat{p}, \mathfrak{g}_\alpha} = \exp(-\frac{1}{2}d_{\mathfrak{g}_\alpha}(\hat{p}, \cdot)^2)$ satisfies:*
 - (i) *It is smooth everywhere and \mathfrak{g} -temporal in U_α whenever $\tau_\alpha \neq 0$, and*
 - (ii) *$\nabla(\tau_\alpha)|_{\hat{q} \in T_{\hat{q}}\partial V}$ for all $\hat{q} \in \partial V$,**where $d_{\mathfrak{g}_\alpha}(\hat{p}, \cdot)$ denotes the Lorentzian distance associated to \mathfrak{g}_α .*

Proof. Let start at the boundary. From the definition of the Gaussian charts:

$$\mathfrak{g}_{\hat{q}} = \sum_{i,j=0}^{n-2} \mathfrak{g}_{ij}(\hat{q}) dx^i dx^j + ds^2 < -\alpha(dx^0)^2 + \sum_{i,j=0}^{n-2} \mathfrak{g}_{ij}(\hat{q}) dx^i dx^j + ds^2, \quad \forall \hat{q} \in U \cap \partial V, \forall \alpha \in (0, 1].$$

Now, for any $\alpha \in (0, 1]$, define \mathfrak{g}_α extending the right hand-side independent of s , and the above inequality remains for small $s > 0$, that is,

$$\mathfrak{g} < -\alpha(dx^0)^2 + \sum_{i,j=0}^{n-2} \mathfrak{g}_{ij}(\cdot, \cdot, 0) dx^i dx^j + ds^2 =: \mathfrak{g}_\alpha \quad \text{on } \hat{U} \times [0, s_\alpha) \quad (3.5)$$

for some $s_\alpha > 0$. Clearly, s_α can be chosen non-decreasing because if $\alpha < \alpha'$ the value of s_α is also valid as $s_{\alpha'}$. Then, consider only values of $\alpha = 1/k$, with $k \in \mathbb{N}$; this would provides a discontinuous “stairs” choice of s_α ; any smooth non-decreasing choice of this stairs function would provide the required one. This proves (1), and the property will hold even if \hat{U} is chosen smaller later.

For (2), recall that all the metrics \mathfrak{g}_α with $\alpha \in [0, 1]$ can be regarded as the restriction of a product metric $\mathfrak{g}_\alpha = \hat{\mathfrak{g}}_\alpha + ds^2$ on all $\hat{U} \times \mathbb{R}$ where the metric $\hat{\mathfrak{g}}_\alpha := \sum_{i,j=0}^{n-2} \mathfrak{g}_{ij}(\cdot, \cdot, 0) dx^i dx^j - \alpha(dx^0)^2$ on the factor \hat{U} varies smoothly with α . So, we can assume that \hat{U} is a convex neighbourhood (i.e., a normal neighborhood of all its points) of \hat{p}_0 for all $\hat{\mathfrak{g}}_\alpha$ and, therefore, so is $\hat{U} \times \mathbb{R}$ for all \mathfrak{g}_α . As a consequence, $d_{\mathfrak{g}_\alpha}(\hat{p}, \cdot)^2$ is smooth where it does not vanish and τ_α is smooth everywhere. Moreover, the level hypersurfaces of $d_{\mathfrak{g}_\alpha}(\hat{p}, \cdot)^2$ are spacelike for the metric \mathfrak{g}_α . So, on each U_α , these levels are also spacelike for the metric \mathfrak{g} , as $\mathfrak{g} < \mathfrak{g}_\alpha$. This implies that

$\nabla(d_{\mathfrak{g}_\alpha}(\hat{p}, \cdot)^2)$ is timelike (and past-directed) whenever it does not vanish on U_α and, thus, the result (i).

For (ii), $d_{\mathfrak{g}_\alpha}$ agrees on U_α when it is computed by regarding \mathfrak{g}_α either as a metric on U_α or as a metric on all $\hat{U} \times \mathbb{R}$. For the latter, the reflection $r(\hat{x}, s) = (\hat{x}, -s)$ is an isometry; thus, $d_{\mathfrak{g}_\alpha}$ and $\nabla d_{\mathfrak{g}_\alpha}$ are invariant for r . \square

As a simple consequence, the local expression of the desired splitting is obtained.

Corollary 3.35. *For each $\hat{p}_0 \in \partial V$ there exists a product neighbourhood $U_0 = (-\epsilon, \epsilon) \times V_0$, where V_0 is an embedded hypersurface with boundary, such that both factors are \mathfrak{g} -orthogonal and \mathfrak{g} is the parametrized product*

$$\mathfrak{g} = -\Lambda d\tau^2 + h_\tau, \quad \tau : (-\epsilon, \epsilon) \times V_0 \rightarrow (-\epsilon, \epsilon) \text{ (natural projection),}$$

where $\Lambda = -1/\mathfrak{g}(\nabla\tau, \nabla\tau)$ is a function on U_0 and h_τ is a Riemannian metric on $\{\tau\} \times V_0$ depending smoothly on τ .

Proof. Consider a Gaussian neighbourhood U as in Prop. 3.34 and choose any $\hat{q} \in I^-(\hat{p}_0, U)$, so that $d_{\mathfrak{g}_\alpha}(\hat{q}, \hat{p}_0) > 0$ for all α . In some open neighbourhood $W \subset U$ of \hat{p}_0 the function τ_α constructed for \hat{q} is strictly positive and, thus, it defines a temporal function on W . Now, consider the spacelike hypersurface $V'_0 := \tau_\alpha^{-1}(\tau_\alpha(\hat{p}_0))$ and the vector field $\nabla\tau_\alpha/|\nabla\tau_\alpha|^2$ in W . Then, for some small $\epsilon > 0$ and neighbourhood $V_0 \subset V'_0$ the flow of $\nabla\tau_\alpha/|\nabla\tau_\alpha|^2$ is well defined and gives the product neighborhood $U_0 = (-\epsilon, \epsilon) \times V_0$. The expression of the metric can be obtained then in a standard way (see the end of the proof of Prop. 2.4 in [14]). \square

Lemma 3.36. *For any $p \in \bar{V}$ there exists some open neighbourhood U in \bar{V} such that*

$$J^+(q, U)_{H^1} \subset cl(I^+(q, U)) \quad \forall q \in U. \quad (3.6)$$

Proof. If $p \in V$, U can be chosen as any convex neighbourhood (see [19, Appendix] $J^+(q, U)_{H^1} = J^+(q, U) \subset cl(I^+(q, U))$). For $\hat{p} \in \partial V$ consider a neighbourhood $U_0 = (-\epsilon, \epsilon) \times V_0$ with compact closure included in a neighbourhood as in Cor. 3.35. Reducing V_0 if necessary, choose a product coordinate chart $(\tau, y^1, \dots, y^{n-2}, y^{n-1} \equiv \bar{s})$ defined on a cube, where the last coordinate satisfies $\{\bar{s} = 0\} \equiv U_0 \cap \partial V$. As causality is conformally invariant, we can also assume $\Lambda \equiv 1$, that is, $\mathfrak{g} = -d\tau^2 + h_\tau$. In order to compute H^1 -norms and distances, consider just the natural Euclidean metrics $|\cdot|$ in these coordinates for both, U_0 and V_0 , as well as for the tangent vectors. Recall that there exists $k_1, k_2 > 0$ such that $k_1|\cdot|^2 \leq h_\tau(\cdot, \cdot) \leq k_2|\cdot|^2$ for all $\tau \in (-\epsilon, \epsilon)$, and these inequalities also remain for the induced distances on V_0 .

Let $q_1 \in J^+(q, U_0)_{H^1}$, and let $\gamma(\tau) = (\tau, y^1(\tau), \dots, y^{n-1}(\tau), \bar{s}(\tau)) \equiv (\tau, y(\tau))$, $\tau \in [\tau_0, \tau_1]$, from $q = (\tau_0, y_0)$ to $q_1 = (\tau_1, y_1)$; thus, $y(\tau)$ is absolutely continuous⁷ with $h_\tau(y'(\tau), y'(\tau)) \leq 1$ a.e. As in [19, Appendix, Lemma A.2], we will prove $(\tau_1, y_1) \in cl(I^+((\tau_0, y_0), U_0))$, by showing that, for any $\epsilon > 0$, there exists some C^1 curve $x_\epsilon(\tau)$ with $x_\epsilon(\tau_0) = y_0$, $x_\epsilon(\tau_1) = y_1$, $\bar{s}(x_\epsilon(\tau)) \geq 0$ and $h_\tau(x'_\epsilon, x'_\epsilon) < (1 + A\epsilon)^2$, where $A > 0$ is independent of ϵ . Indeed, in this case the curve $\gamma_\epsilon(\tau) = ((1 + A\epsilon)(\tau - \tau_0) + \tau_0, x_\epsilon(\tau))$ is a C^1 -timelike curve between $q = (\tau_0, y_0)$ and $q_{1+\epsilon} = ((1 + A\epsilon)(\tau_1 - \tau_0) + \tau_0, y_1)$, where $\lim_{\epsilon \rightarrow 0} q_{1+\epsilon} = q_1$.

To avoid the boundary for the smoothed curves x_ϵ , first $y(\tau)$ will be perturbed into some $y_\epsilon(\tau)$ as follows. For each $0 < \epsilon < 1$ choose a smooth function $\alpha_\epsilon(\tau)$, satisfying: (i) $\alpha_\epsilon(\tau) \geq 0$ with equality only at τ_0, τ_1 , (ii) $\alpha'_\epsilon(\tau_0) > 0$, $\alpha'_\epsilon(\tau_1) < 0$, (iii) $\alpha_\epsilon(\tau), |\alpha'_\epsilon(\tau)| < \epsilon$. Let $y_\epsilon(\tau) := (y^1(\tau), \dots, y^{n-2}(\tau), \bar{s}(\tau) + \alpha_\epsilon(\tau))$ for all $\tau \in [\tau_0, \tau_1]$. Using (iii),

$$\begin{aligned} h_\tau(y'_\epsilon, y'_\epsilon) &= h_\tau(y' + \alpha'_\epsilon \partial_{\bar{s}}, y' + \alpha'_\epsilon \partial_{\bar{s}}) \\ &= h_\tau(y', y') + 2h_\tau(y', \alpha'_\epsilon \partial_{\bar{s}}) + h_\tau(\alpha'_\epsilon \partial_{\bar{s}}, \alpha'_\epsilon \partial_{\bar{s}}) < (1 + \epsilon A/2)^2, \end{aligned}$$

⁷ In particular, the reparametrization by means of a temporal function of any H^1 -causal curve will be H^1 as it would satisfy $k_1|y'(\tau)|^2 \leq h_\tau(y'(\tau), y'(\tau)) \leq 1$ a.e.

for some constant $A > 1$; in particular, y_ϵ is an H^1 -curve from y_0 to y_1 .

Now, notice that the requirement (i) for $\alpha_\epsilon(\tau)$ implies that y_ϵ has at most two points in the boundary (its endpoints); indeed, $\tilde{s}(y_\epsilon(\tau)) > 0$ for all $\tau \in (\tau_0, \tau_1)$. Moreover, the requirement (iii) implies that the derivative of $\tilde{s} \circ y_\epsilon$ has a definite sign a.e. close to the endpoints. Considering the extensions of the metric \mathfrak{g} and coordinates (τ, y) to some neighborhood \tilde{U}_0 of the double manifold (extending consistently V_0 in some \tilde{V}_0), the density of the space $C^\infty([\tau_0, \tau_1], \tilde{V}_0)$ in $H^1([\tau_0, \tau_1], \tilde{V}_0)$ can be used. Then, any C^∞ curve x_ϵ with the same endpoints as y_ϵ enough close to y_ϵ in the H^1 -norm will satisfy the required properties, namely:

(a) $x_\epsilon(\tau)$ remains in V_0 (and, moreover, it does not touch the boundary except at its endpoints). Indeed, for all enough H^1 -close C^∞ -curves, the convergence of the functions implied by the H^1 -norm (in addition to (i)) yields the required property outside any arbitrarily small neighbourhood of the endpoints. Moreover, the convergence of the derivatives (in addition to (ii)) yields the property also in some small neighbourhood of both endpoints.

(b) $h_\tau(x'_\epsilon, x'_\epsilon) < (1 + \epsilon A)^2$, (by a straightforward use of the convergence of both, the functions and their derivatives⁸). \square

Proposition 3.37. *For any causally simple spacetime with timelike boundary (\bar{V}, \mathfrak{g}) , the following holds: $J^\pm(p) = J^\pm(p)_{H^1}$ for all $p \in \bar{V}$.*

Proof. Reasoning for the future, the problem reduces to prove

$$J^+(p)_{H^1} \subset cl(I^+(p)) \quad \forall p \in \bar{V} \quad (3.7)$$

because, the chain of inclusions $J^+(p) \subset J^+(p)_{H^1} \subset cl(I^+(p)) = cl(J^+(p)) = J^+(p)$. would hold (the last equality by the causal simplicity of the spacetime, Prop. 3.23, and the previous one by Prop. 3.5). So, take any $q \in J^+(p)_{H^1}$ and let $\gamma : [r_0, r_1] \rightarrow \bar{V}$ be some future-directed H^1 -causal curve joining p with q . From Lemma 3.36, given any point $\gamma(r)$, there exists some open neighbourhood $U_{\gamma(r)}$ such that $J^+(q', U_{\gamma(r)})_{H^1} \subset cl(I^+(q', U_{\gamma(r)}))$ for all $q' \in U_{\gamma(r)}$. As γ is continuous, there exists some $\delta(r) > 0$ such that $\gamma((r - \delta(r), r + \delta(r))) \subset U_{\gamma(r)}$. Consider the open covering $\{(r - \delta(r), r + \delta(r))\}_{r \in [r_0, r_1]}$ of $[r_0, r_1]$, and denote by $\delta > 0$ a Lebesgue number associated to it. Let $\{w_0 := r_0, w_1, w_2, \dots, w_{l-1}, w_l := r_1\}$ be a partition of the interval $[r_0, r_1]$ with diameter smaller than δ . The case $l = 1$ is trivial and assume by induction that it is true for $l - 1$. Let r so that $\gamma([w_{l-1}, r_1]) \subset U_{\gamma(r)}$ and, thus, $\gamma(r_1) \in cl(I^+(\gamma(w_{l-1}), U_{\gamma(r)}))$. So, there is a sequence $\{q_m\} \rightarrow \gamma(r_1) = q$ such that $\gamma(w_{l-1}) \in I^-(q_m, U_{\gamma(r)})$ for all m . Therefore, for each q_m all the points in some neighbourhood $U_m \ni \gamma(w_{l-1})$ lie in $I^-(q_m, U_{\gamma(r)})$. By the hypothesis of induction, some $z_m \in U_m$ belongs to $I^+(p)$ and, so, $p \ll z_m \ll q_m$ for all m , the last implies that $q_m \in I^+(p)$, so, $q \in cl(I^+(p))$ as required. \square

⁸Recalling that a.e. bounds for smooth functions imply the full bounds.

Appendix. Compact affine manifolds with precompact holonomy are geodesically complete

The purpose of the present appendix is to prove the following result:

Theorem 1. *Let M be a (Hausdorff, connected, smooth) compact m -manifold endowed with a linear connection ∇ and let $p \in M$. If the holonomy group $\text{Hol}_p(\nabla)$ (regarded as a subgroup of the group $\text{Gl}(T_p M)$ of all the linear automorphisms of the tangent space at p , $T_p M$) has compact closure, then (M, ∇) is geodesically complete.*

Some comments on the completeness of compact affine manifolds are in order. There are several results when ∇ is *flat* and, therefore, there exists an atlas \mathcal{A} whose transition functions are affine maps of \mathbb{R}^m ; in this case, the linear parts will lie in some subgroup G of the (real) general linear group $\text{Gl}(m)$. In fact, a well-known conjecture by Markus states that compact affine flat manifolds which are unimodular (i.e., G can be chosen in the special linear group $\text{Sl}(m)$) must be complete. Carrière [21] introduced an invariant for linear groups, the *discompactness*, which measures the non-compactness of the group by analyzing the degeneration of images of the unit sphere under the action of sequences of its elements. When the closure \bar{G} is compact, the *discompactness* is equal to 0; Markus conjecture was proven in [21] under the assumption that the *discompactness* of G is at most 1. Other results on the structure of unimodular manifolds (see for example, [22]) can be also regarded as partial answers to that conjecture.

When ∇ is the Levi-Civita connection of a Riemannian metric g , the (geodesic) completeness of ∇ , which follows directly from Hopf-Rinow theorem, can be reobtained from Theorem 1; indeed, $\text{Hol}_p(\nabla)$ becomes a subgroup of the (orthogonal) group of linear isometries $\text{O}(T_p M)$, which is compact. However, when g is an indefinite semi-Riemannian metric of index ν ($0 < \nu < m$), the corresponding orthogonal group $\text{O}_\nu(T_p M)$ is non-compact and completeness may not hold; the Clifton-Pohl torus (see for instance [83, Example 7.16]) is a well-known example. There are some results that assure the completeness of a compact semi-Riemannian manifold, among them either to admit ν pointwise independent conformal Killing vector fields which span a negative definite subbundle of TM [89, 90], or to be homogeneous [73] (local homogeneity is also enough in dimension 3 [30], and to be conformal to a homogeneous manifold is enough in any dimension [89]; see [93] for a review).

In the particular case that the semi-Riemannian manifold (M, g) is Lorentzian ($\nu = 1 < m$), compactness implies completeness in other relevant cases, such as when g is flat. Indeed, taking if necessary a finite covering, this is a particular case of Markus' conjecture where G can be regarded as the restricted Lorentz group $\text{SO}_1^\uparrow(m)$ (i.e., the connected component of the identity of the Lorentz group $\text{O}_1(m)$) and, as also proven by Carrière in [21], the *discompactness* of $\text{SO}_1^\uparrow(m)$ is equal to 1. It is worth pointing out that, when the group G determined by a compact flat affine manifold lies in the group of Lorentzian similarities (generated by homotheties and $\text{O}_1(m)$) but not in the Lorentz group, then the connection is incomplete [6]. Moreover, Klingler

[63] extended Carrière’s result by showing that any compact Lorentzian manifold of constant curvature is complete, and Leistner and Schliebner [66] proved that completeness also holds in the case of Abelian holonomy (compact pp-waves).

These semi-Riemannian results are independent of Theorem 1; in fact, Gutiérrez and Müller [53] have proven recently that, for a Lorentzian metric g , the compactness of $\text{Hol}(g)$ implies the existence of a timelike parallel vector field in a finite covering. This conclusion (combined with the cited one in [90]) also gives an alternative proof of Theorem 1 in the particular case that ∇ comes from a Lorentzian metric. In any case, the proof of our theorem is very simple and extends or complements the previous results.

Proof of Thm. 1. Assume that there exists an incomplete geodesic $\gamma : [0, b) \rightarrow M$, $b < \infty$. By using the compactness of M , choose any sequence $\{t_n\}_n \nearrow b$ such that $\{\gamma(t_n)\}_n$ converges to some $p \in M$. It is well-known then that the sequence of velocities $\{\gamma'(t_n)\}_n$ cannot converge in TM as γ' is the integral curve of the geodesic vector field on TM (see for example Prop. 3.28 and Lemma 1.56 in [83] or [93, Section 3]). Consider a normal (starshaped) neighbourhood U of p (see for example [86, 102] for background results on linear connections). With no loss of generality, we will assume that $\{\gamma(t_n)\}_n \subset U$ and will arrive at a contradiction with the compactness of $\overline{\text{Hol}_p(\nabla)}$.

Consider the loops at p given by $\alpha_n = \rho_n^{-1} \star \gamma_{[t_1, t_n]} \star \rho_1$, where \star denotes the concatenation of the corresponding curves and $\rho_n : [0, 1] \rightarrow U$ is the radial geodesic from p to $\gamma(t_n)$ for all $n = 1, 2, \dots$. Put $v_p = \tau_{\rho_1^{-1}}(\gamma'(t_1)) \in T_pM$. For any curve $\alpha : [a, b] \rightarrow U$, let τ_α be the parallel transport between its endpoints. As γ is a geodesic:

$$v_n := \tau_{\alpha_n}(v_p) = \tau_{\rho_n^{-1}} \circ \tau_{\gamma_{[t_1, t_n]}} \circ \tau_{\rho_1}(\tau_{\rho_1^{-1}}(\gamma'(t_1))) = \tau_{\rho_n^{-1}}(\gamma'(t_n))$$

(in particular, $v_1 = v_p$). The compactness of $\overline{\text{Hol}_p(\nabla)}$ implies that the sequence $\{v_n\}_n$ is contained in a compact subset $K \subset T_pM$. So, it is enough to check that this property also implies that $\{\gamma'(t_n)\}_n$ is included in a compact subset of TM .

With this aim, let $\tilde{K} \subset \exp^{-1}(U)$ be a starshaped compact neighborhood of $0 \in T_pM$ and, for each $u \in \tilde{K}$, let $\rho_u : [0, 1] \rightarrow U$ be the radial geodesic segment with initial velocity u . As the map

$$\xi : \tilde{K} \times K \rightarrow TM, \quad (u, v) \mapsto \xi(u, v) = \tau_{\rho_u}(v)$$

is continuous, its image $\xi(\tilde{K}, K)$ is compact. This set contains all $\{\gamma'(t_n)\}_n$ up to a finite number (recall that $\gamma(t_n)$ lies in $\exp_p(\tilde{K})$ and $\rho_{u_n} = \rho_n$ for $u_n = \exp^{-1}(\gamma(t_n))$, i.e., $\gamma'(t_n) = \xi(u_n, v_n)$), as required.

□

- [1] L. Aké, J. L. Flores, and J. Herrera. Causality and c-completion of multiwarped spacetimes. *Class. Quant. Grav.*, 35(3):035014, 38, 2018.
- [2] L. Aké, J. L. Flores, and M. Sánchez. Splitting of globally hyperbolic spacetimes with timelike boundary. *In progress*, 2018.
- [3] L. Aké and J. Herrera. Spacetime coverings and the causal boundary. *J. High Energy Phys.*, 2017(4):51, 2017.
- [4] L. Aké and M. Sánchez. Compact affine manifolds with precompact holonomy are geodesically complete. *J. Math. Anal. Appl.*, 436(2):1369–1371, 2016.
- [5] V. Alaña and J. L. Flores. The causal boundary of product spacetimes. *Gen. Relat. Gravit.*, 39(10):1697–1718, 2007.
- [6] T. Aristide. Closed similarity Lorentzian affine manifolds. *Proc. Amer. Math. Soc.*, 132(12):3697–3702, 2004.
- [7] M. Bañados, M. Henneaux, C. Teitelboim, and J. Zanelli. Geometry of the 2 + 1 blackhole. *Phys. Rev. D.*, 48(4):1506–1525, 1993.
- [8] M. Bañados, C. Teitelboim, and J. Zanelli. The black hole in three-dimensional spacetime. *Phys. Rev. Lett.*, 69(13):1849–1851, 1992.
- [9] C. Bär, N. Ginoux, and F. Pfäffle. *Wave equations on Lorentzian manifolds and quantization*. ESI Lectures in Mathematics and Physics. European Mathematical Society (EMS), Zürich, 2007.
- [10] R. Bartolo, A. Germinario, and M. Sánchez. Convexity of domains of riemannian manifolds. *Ann. Global Anal. Geom.*, 21(1):63–84, 2002.
- [11] J. K. Beem, P. E. Ehrlich, and K. L. Easley. *Global Lorentzian Geometry*, volume 202 of *Pure and Applied Mathematics*. Marcel Dekker, New York, 1996.
- [12] D. Berenstein, J. Maldacena, and H. Nastase. Strings in flat space and pp waves from $N = 4$ super Yang Mills. *J. High Energy Phys.*, (4):No. 13, 30, 2002.
- [13] A. Bernal and M. Sánchez. On smooth Cauchy hypersurfaces and Geroch’s splitting theorem. *Comm. Math. Phys.*, 243(3):461–470, 2003.

- [14] A. Bernal and M. Sánchez. Smoothness of time functions and the metric splitting of globally hyperbolic spacetimes. *Comm. Math. Phys.*, 257(1):43–50, 2005.
- [15] A. Bernal and M. Sánchez. Further results on the smoothability of Cauchy hypersurfaces and Cauchy time functions. *Lett. Math. Phys.*, 77(2):183–197, 2006.
- [16] A. Bernal and M. Sánchez. Globally hyperbolic spacetimes can be defined as ‘causal’ instead of ‘strongly causal’. *Class. Quant. Grav.*, 24(3):745–749, 2007.
- [17] P. Bernard and S. Suhr. Lyapounov functions of closed cone fields: From Conley theory to time functions. *Comm. Math. Phys.*, 359(2):467–498, 2018.
- [18] R. Budic and R. K. Sachs. Causal boundaries for general relativistic space-times. *J. Math. Phys.*, 15(8):1302–1309, 1974.
- [19] A. M. Candela, J. L. Flores, and M. Sánchez. Global hyperbolicity and Palais-Smale condition for action functionals in stationary spacetimes. *Adv. Math.*, 218(2):515–536, 2008.
- [20] E. Caponio, A. V. Germinario, and M. Sánchez. Convex regions of stationary spacetimes and Randers spaces. Applications to lensing and asymptotic flatness. *J. Geom. Anal.*, 26(2):791–836, 2016.
- [21] Y. Carrière, F. Dal’bo, and G. Meigniez. Inexistence de structures affines sur les fibrés de Seifert. *Math. Ann.*, 296(4):743–753, 1993.
- [22] Y. Carrière, F. Dal’bo, and G. Meigniez. Inexistence de structures affines sur les fibrés de Seifert. *Math. Ann.*, 296(4):743–753, 1993.
- [23] Y. Choquet-Bruhat. Problème de Cauchy pour le système intégro différentiel d’Einstein-Liouville. *Ann. Inst. Fourier (Grenoble)*, 21(3):181–201, 1971.
- [24] Y. Choquet-Bruhat and R. Geroch. Global aspects of the Cauchy problem in general relativity. *Comm. Math. Phys.*, 14:329–335, 1969.
- [25] P. Chruściel, G. Galloway, and D. Solís. Topological censorship for Kaluza-Klein spacetimes. *Ann. Henri Poincaré*, 10(5):893–912, 2009.
- [26] P. Chruściel, J. D. E. Grant, and E. Minguzzi. On differentiability of volume time functions. *Ann. Henri Poincaré*, 17(10):2801–2824, 2016.
- [27] P. T. Chruściel. Conformal boundary extensions of Lorentzian manifolds. *J. Differential Geom.*, 84(1):19–44, 2010.
- [28] J. Dieckmann. Volume functions in general relativity. *Gen. Rel. Gravit.*, 20(9):859–867, 1988.
- [29] A. Dionysios, T. Hartman, and A. Strominger. Higher spin realization of the dS/CFT correspondence. *Class. Quant. Grav.*, 34(1):015009, 2017.
- [30] S. Dumitrescu and A. Zeghib. Géométries lorentziennes de dimension 3: classification et complétude. *Geom. Dedicata*, 149:243–273, 2010.
- [31] A. Enciso and N. Kamran. Lorentzian Einstein metrics with prescribed conformal infinity. *arXiv preprint arXiv:1412.4376*, 2014.

- [32] A. Enciso and N. Kamran. Determining an asymptotically AdS Einstein spacetime from data on its conformal boundary. *Gen. Rel. Gravit.*, 47(12):Art. 147, 11, 2015.
- [33] A. Fathi and A. Siconolfi. On smooth time functions. *Math. Proc. Cambridge Philos. Soc.*, 152(2):303–339, 2012.
- [34] J. L. Flores. The causal boundary of spacetimes revisited. *Comm. Math. Phys.*, 276(3):611–643, 2007.
- [35] J. L. Flores, J. Herrera, and M. Sánchez. On the final definition of the causal boundary and its relation with the conformal boundary. *Adv. Theor. Math. Phys.*, 15(4):991–1057, 2011.
- [36] J. L. Flores, J. Herrera, and M. Sánchez. Computability of the causal boundary by using isocausality. *Class. Quant. Grav.*, 30(7):075009, 2013.
- [37] J. L. Flores, J. Herrera, and M. Sánchez. Gromov, Cauchy and causal boundaries for Riemannian, Finslerian and Lorentzian manifolds. *Mem. Amer. Math. Soc.*, 226(1064):vi+76, 2013.
- [38] J. L. Flores, J. Herrera, and M. Sánchez. Hausdorff separability of the boundaries for spacetimes and sequential spaces. *J. Math. Phys.*, 57(2):022503, 25, 2016.
- [39] J. L. Flores, J. Herrera, and M. Sánchez. Isocausal spacetimes may have different causal boundaries. *Class. Quant. Grav.*, 28(17):175016, 2011.
- [40] J. L. Flores and M. Sánchez. Geodesic connectedness of multiwarped spacetimes. *J. Differential Equations*, 186(1):1–30, 2002.
- [41] J. L. Flores and M. Sánchez. The causal boundary of wave-type spacetimes. *J. High Energy Phys.*, (3):036, 43, 2008.
- [42] J. Fritz. *Partial differential equations*, volume 1 of *Applied Mathematical Sciences*. Springer-Verlag, New York, fourth edition, 1991.
- [43] G. Galloway. Notes on Lorentzian Geometry. In *ESI-EMS-IAMP Summer School on Mathematical Relativity*, 2014.
- [44] G. Galloway and D. Solís. Uniqueness of de Sitter space. *Class. Quant. Grav.*, 24(11):3125–3138, 2007.
- [45] A. García-Parrado and J. M. M. Senovilla. Causal relationship: a new tool for the causal characterization of Lorentzian manifolds. *Class. Quant. Grav.*, 20(4):625–664, 2003.
- [46] A. García-Parrado and J. M. M. Senovilla. Causal structures and causal boundaries. *Class. Quant. Grav.*, 22(9):R1–R84, 2005.
- [47] R. Geroch. Domain of dependence. *J. Math. Phys.*, 11:437–449, 1970.
- [48] R. Geroch, E. H. Kronheimer, and R. Penrose. Ideal points in space-time. *Proc. Roy. Soc. Lond. A*, 327(1571):545–567, 1972.
- [49] A. Ghodsi and M. Garousi. The RN/CFT correspondence. *Phys. Lett. B*, 687(1):79 – 83, 2010.

- [50] G. Gibbons. Aspects of supergravity theories. In *XV GIFT Seminar on Supersymmetry and Supergravity Gerona, Spain, June 4-11, 1984*, 1984.
- [51] J. R. Gott, III. Closed timelike curves produced by pairs of moving cosmic strings: exact solutions. *Phys. Rev. Lett.*, 66(9):1126–1129, 1991.
- [52] M. Guica, T. Hartman, W. Song, and A. Strominger. The Kerr/CFT correspondence. *Phys. Rev. D*, 80:124008, 2009.
- [53] M. Gutiérrez and O. Müller. Compact Lorentzian holonomy. *Differential Geom. Appl.*, 48:11–22, 2016.
- [54] S. Harris. Universality of the future chronological boundary. *J. Math. Phys.*, 39(10):5427–5445, 1998.
- [55] S. Harris. Topology of the future chronological boundary: universality for spacelike boundaries. *Class. Quant. Grav.*, 17(3):551–603, 2000.
- [56] S. Harris. Discrete group actions on spacetimes: causality conditions and the causal boundary. *Class. Quant. Grav.*, 21(4):1209–1236, 2004.
- [57] S. Harris. Boundaries on spacetimes: causality, topology, and group actions. *Geom. Dedicata*, 126:255–274, 2007.
- [58] S. Harris. Complete affine connection in the causal boundary: static, spherically symmetric spacetimes. *Gen. Rel. Gravit.*, 49(2):Art. 31, 37, 2017.
- [59] S. Harris. Erratum to: Complete affine connection in the causal boundary: static, spherically symmetric spacetimes [MR3603816]. *Gen. Rel. Gravit.*, 49(3):Art. 40, 1, 2017.
- [60] T. Hartman, K. Murata, T. Nishioka, and A. Strominger. CFT duals for extreme black holes. *J. High Energy Phys.*, 2009(04):019, 2009.
- [61] S. W. Hawking and G. F. R. Ellis. *The Large Scale Structure of Space-Time (Cambridge Monographs on Mathematical Physics)*. Cambridge University Press, 1975.
- [62] S. W. Hawking and Don N. Page. Thermodynamics of black holes in anti-de Sitter space. *Comm. Math. Phys.*, 87(4):577–588, 1982/83.
- [63] B. Klingler. Complétude des variétés lorentziennes à courbure constante. *Math. Ann.*, 306(2):353–370, 1996.
- [64] J. V. Kroon. *Conformal methods in general relativity*. Cambridge Monographs on Mathematical Physics. Cambridge University Press, Cambridge, 2016.
- [65] J. M. Lee. *Introduction to smooth manifolds*. Graduate Texts in Mathematics. Springer, New York, second edition, 2013.
- [66] T. Leistner and D. Schliebner. Completeness of compact Lorentzian manifolds with abelian holonomy. *Math. Ann.*, 364(3-4):1469–1503, 2016.
- [67] U. Lupo. *Aspects of (quantum) field theory on curved spacetimes, particularly in the presence of boundaries*. PhD thesis, Queensland University of Technology, 2015.
- [68] U. Lupo. On the global “two-sided” characteristic Cauchy problem for linear wave equations on manifolds. *arXiv preprint arXiv:170804953*, 2017.

- [69] J. Maldacena. The large N limit of superconformal field theories and supergravity [MR1633016 (99e:81204a)]. In *Trends in theoretical physics, II (Buenos Aires, 1998)*, volume 484 of *AIP Conf. Proc.*, pages 51–63. Amer. Inst. Phys., Woodbury, NY, 1999.
- [70] J. Maldacena and C. Nuñez. Supergravity description of field theories on curved manifolds and a no go theorem. *Int. J. Mod. Phys. A*, 16(05):822–855, 2001.
- [71] D. Marolf and S. F. Ross. Plane waves: to infinity and beyond! *Class. Quant. Grav.*, 19(24):6289–6302, 2002.
- [72] D. Marolf and S. F. Ross. A new recipe for causal completions. *Class. Quant. Grav.*, 20(18):4085–4117, 2003.
- [73] J. Marsden. On completeness of homogeneous pseudo-riemannian manifolds. *Indiana Univ. J.*, 22:1065–1066, 1972/73.
- [74] A. Masiello. *Variational methods in Lorentzian geometry*. Pitman Research Notes in Mathematics Series. Longman Scientific & Technical, Harlow; New York, 1994.
- [75] G. Mess. Lorentz spacetimes of constant curvature. *Geom. Dedicata*, 126(1):3–45, 2007.
- [76] E. Minguzzi. On the existence of smooth Cauchy steep time functions. *Class. Quant. Grav.*, 33(11):115001, 4, 2016.
- [77] E. Minguzzi and M. Sánchez. The causal hierarchy of spacetimes. In *Recent developments in pseudo-Riemannian geometry*, ESI Lect. Math. Phys., pages 299–358. Eur. Math. Soc., Zürich, 2008.
- [78] O. Müller. Asymptotic flexibility of globally hyperbolic manifolds. *C. R. Math. Acad. Sci. Paris*, 350(7-8):421–423, 2012.
- [79] O. Müller. Special temporal functions on globally hyperbolic manifolds. *Lett. Math. Phys.*, 103(3):285–297, 2013.
- [80] O. Müller. Horizons. *Adv. Theor. Math. Phys.*, 19(4):747–760, 2015.
- [81] O. Müller. A note on invariant temporal functions. *Lett. Math. Phys.*, 106(7):959–971, 2016.
- [82] O. Müller. Which spacetimes admit conformal compactifications? *Adv. Theor. Math. Phys.*, 20(5):1109–1124, 2016.
- [83] B. O’Neill. *Semi-Riemannian Geometry With Applications to Relativity, 103, Volume 103 (Pure and Applied Mathematics)*. Academic Press, 1983.
- [84] J. Pérez. *Notas sobre geometría Riemanniana global*. Universidad de Granada, 2000.
- [85] V. Perlick. Gravitational lensing from a spacetime perspective. *Living Rev. Relativ.*, 7(1):9, 2004.
- [86] M. M. Postnikov. *Geometry VI: Riemannian geometry*, volume 91 of *Encyclopaedia of Math. Sci.* Springer-Verlag, Berlin, 2001.
- [87] I. Rácz. Causal boundary of space-times. *Phys. Rev. D (3)*, 36(6):1673–1675, 1987.

- [88] H. Ringström. *The Cauchy problem in general relativity*. ESI Lectures in Mathematics and Physics. European Mathematical Society (EMS), Zürich, 2009.
- [89] A. Romero and M. Sánchez. On completeness of certain families of semi-Riemannian manifolds. *Geom. Dedicata*, 53(1):103–117, 1994.
- [90] A. Romero and M. Sánchez. Completeness of compact Lorentz manifolds admitting a timelike conformal Killing vector field. *Proc. Amer. Math. Soc.*, 123(9):2831–2833, 1995.
- [91] M. Sánchez. Causal hierarchy of spacetimes, temporal functions and smoothness of Geroch’s splitting. A revision. *Mat. Contemp.*, 29:127–155, 2005.
- [92] M. Sánchez. Causal boundaries and holography on wave type spacetimes. *Nonlinear Anal.*, 71(12):e1744–e1764, 2009.
- [93] M. Sánchez. On the completeness of trajectories for some mechanical systems. In *Geometry, mechanics, and dynamics*, volume 73 of *Fields Inst. Commun.*, pages 343–372. Springer, New York, 2015.
- [94] H. Seifert. Smoothing and extending cosmic time functions. *Gen. Relat. Gravit.*, 8(10):815–831, 1977.
- [95] D. Solís. *Global properties of asymptotically de Sitter and Anti de Sitter spacetimes*. PhD thesis, University of Miami, 2006.
- [96] A. Strominger. The dS/CFT correspondence. *J. High Energy Phys.*, 2001(10):034, 2001.
- [97] L. Susskind. The world as a hologram. *J. Math. Phys.*, 36(11):6377–6396, 1995.
- [98] L. B. Szabados. Causal boundary for strongly causal spacetimes. *Class. Quant. Grav.*, 5(1):121, 1988.
- [99] L. B. Szabados. Causal boundary for strongly causal spacetimes II. *Class. Quant. Grav.*, 6(1):77–91, 1989.
- [100] G. ’t Hooft. Dimensional reduction in quantum gravity. In *Salamfest 1993:0284-296*, pages 0284–296, 1993.
- [101] R. M. Wald. *General Relativity*. University of Chicago Press, 1984.
- [102] J. H. C. Whitehead. Convex regions in the geometry of paths. *Quart. J. Math. Oxford Ser.*, 3(1):33–42, 1932.
- [103] E. Witten. Anti-de Sitter space, thermal phase transition and confinement in gauge theories. *Int. J. Mod. Phys. A*, 16(16):2747–2769, 2001.
- [104] E. Witten. Anti-de Sitter space, thermal phase transition and confinement in gauge theories. *Int. J. Mod. Phys. A*, 16(16):2747–2769, 2001.
- [105] E. Witten. Quantum gravity in de Sitter space. In *Strings 2001: International Conference Mumbai, India, January 5-10, 2001*, 2001.